

International Conference

REFORESTATION CHALLENGES

Belgrade, Serbia

03-06 June 2015

PROCEEDINGS

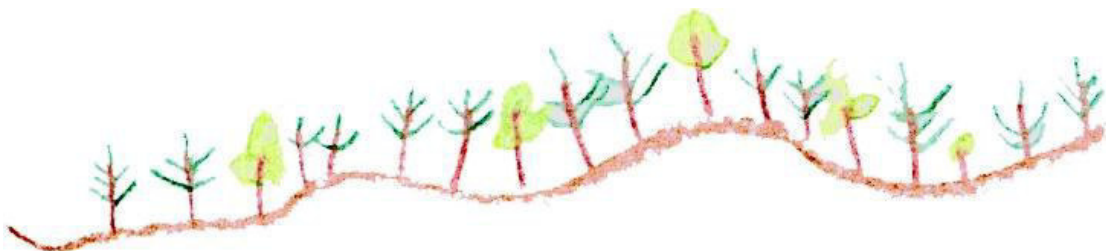

95th anniversary



International Conference

REFORESTATION CHALLENGES

Belgrade, Serbia

03-06 June 2015

PROCEEDINGS

Editors:

Vladan Ivetić and Dragica Stanković

University of Belgrade – Faculty of Forestry

Organized by:

University of Belgrade - Faculty of Forestry

IUFRO

REFORESTA

This document is being published in electronic format only (Web and CD). Any corrections or additions will be posted to the Web site (www.reforestationchallenges.org).

DISCLAIMER: The papers in this book comprise the proceedings of the event mentioned on the cover and title page.

The findings and conclusions of each article in this publication are those of the individual author(s) and do not necessarily represent the views of the University of Belgrade – Faculty of Forestry, International Union of Forest Research Organizations (IUFRO) or Scientific and Professional Society REFORESTA.

All articles were received in digital format and were edited for uniform type and style.

Each author is responsible for the accuracy and content of his or her paper.

First published: September 2015

Edition: e-publishing

© REFORESTA, Scientific-professional society

Internet: www.reforestationchallenges.org

Publisher: REFORESTA (Kneza Višeslava 1, 11030 Belgrade, Serbia)

Cover drawing: Kosta Ivetić

Cover photo: Simon Place

ISBN 978-86-918861-1-0

SCIENTIFIC COMMITTEE

Vladan Ivetić, SERBIA
Steven Grossnickle, CANADA
Kasten Dumroese, USA
Anders Mattsson, SWEDEN
Douglass Jacobs, USA
Christopher Keyes, USA
Dragica Vilotić, SERBIA
Marianthi Tsakalimi, GREECE
Milan Mataruga, BOSNIA AND
HERZEGOVINA
Mirjana Šijačić-Nikolić, SERBIA
Milan Medarević, SERBIA
Milko Milev, BULGARIA
Nenad Keča, SERBIA
Berthold Heinze, AUSTRIA
Dana Dina Kolevska, FYR MACEDONIA
Dutca Ioan, ROMANIA
Ratko Ristić, SERBIA
Predrag Aleksić, SERBIA
Aleksandar Lučić, SERBIA
Roman Longauer, SLOVAKIA

ORGANIZING COMMITTEE

Dragica Stanković, SERBIA
Jovana Devetaković, SERBIA
Tatjana Ćirković-Mitrović, SERBIA
Zoran Baković, SERBIA
Vladan Popović, SERBIA
Marina Nonić, SERBIA
Dušan Jokanović, SERBIA
Perica Grbić, SERBIA
Goran Trivan, SERBIA
Ljiljana Sovilj, SERBIA
Branislav Cvjetković, BOSNIA AND
HERZEGOVINA
Zoran Maksimović, SERBIA
Milena Anđelić, SERBIA

Sponsors:



Ivetić V., Stanković D. eds. (2015). Proceedings: International conference Reforestation Challenges, 03-06 June 2015, Belgrade, Serbia. Reforesta. 301 p. ISBN 978-86-918861-1-0

Abstract: This book of Proceedings compiles 35 papers presented by researchers and scientists at The International Conference on Reforestation Challenges. Topics included various aspects of reforestation: 1) Planning and management of reforestation programs; 2) Stocktypes and seedlings quality; 3) Monitoring reforestation successes; 4) Planting and seedling-site interaction; 5) Species, intra-species and seed source selection and 6) Plant health in nurseries and plantations. In addition to country reports on current and past reforestation efforts and success, a new plans and strategies are presented. Market potential of poplar plantations is analyzed. Nursery operations affect seedlings quality by changing of seedlings density and container type, as well as by controlling the light conditions. Seedlings quality attributes are strongly related, both morphological and physiological. Endangered species, like elms can be successfully reproduced by mass clonal production. Variability between provenances should be concerned in initial stage of reforestation programs by selection of appropriate source of forest reproductive material. A local heat potential can be used for site-species matching. Local species, like European white elm can be used for wetland restoration and some exotic species are tested for potential use. Field success can be improved by use of microorganisms and site preparation, including soil conditioning and mulching techniques. Different methods of site preparations were presented, with emphasis on economy behind these operations. Innovative sowing technique from the air can be used on inaccessible sites. Management have a significant effect on plantation development and success in growing phase. Hydrophilic forests depend on river water and groundwater level. Additional ecosystem service of forests is carbon accumulation after afforestation of bare land.

Keywords: reforestation, seedlings, nursery operations, site preparation, seedling-site interaction.

CONTENT

Ivetić V.	REFORESTATION IN SERBIA: SUCCESS OR FAILURE?	1-12
Ratknić M., Rakonjac Lj., Braunović S., Miletić Z., Ratknić T.	THE REPUBLIC OF SERBIA'S AFFORESTATION STRATEGY WITH AN ACTION PLAN	13-22
Ratknić M., Rakonjac Lj., Braunović S., Čirković- Mitrović T., Stajić S., Ratknić T.	BELGRADE AFFORESTATION STRATEGY	23-32
Keča Lj., Keča N.	MARKET POTENTIAL DYNAMICS FOR PLANTATION-GROWN POPLAR FOREST PRODUCTS IN SERBIA	33-41
Karličić V., Radić D., Jovičić Petrović J., Golubović-Čurguz V., Kiković D., Raičević V.	INOCULATION OF <i>ROBINIA PSEUDOACACIA</i> L. AND <i>PINUS SYLVESTRIS</i> L. SEEDLINGS WITH PLANT GROWTH PROMOTING BACTERIA CAUSES INCREASED GROWTH IN COAL MINE OVERBURDEN	42-49
Kolevska D.D., Trajkov P., Maletic V.	EFFECTS OF SPACING BLACK LOCUST (<i>ROBINIA PSEUDOACACIA</i> L.) SEEDLINGS IN STRIPES ON MORPHOLOGICAL CHARACTERISTICS AND YIELD PER UNIT AREA	50-59
Grbić M., Skočajić D., Đukić M., Đunisijević- Bojović D., Marković M.	MASS CLONAL PROPAGATION OF ELMS AS WAY FOR REPLACEMENT OF ENDANGERED AUTOCHTHONOUS SPECIES	60-67
Čirković-Mitrović T., Ivetić V., Vilotić D., Brašanac-Bosanac Lj., Popović V.	RELATION BETWEEN MORPHOLOGICAL ATTRIBUTES OF FIVE WILD FRUIT TREE SPECIES SEEDLINGS IN SERBIA	68-77
Kolevska D.D., Trajkov P., Maletic V., Terziska M.	DYNAMIC OF GROWTH AND QUALITY OF ARIZONA CYPRESS (<i>CUPRESSUS ARIZONICA</i> GREENE) SEEDLINGS FROM THREE CONTAINER TYPES	78-87
Batos B., Miletić Z., Miljković D.	RELATIONSHIPS BETWEEN SPECIFIC LEAF AREA AND MACRONUTRIENT CONCENTRATIONS OF PEDUNCULATE OAK (<i>QUERCUS ROBUR</i> L.) LEAVES	88-98
Škorić M., Devetaković J.	SEEDLING PRODUCTION IN "GOČKO" CONTAINER	99-103
Lukić S., Kadović R., Knežević M., Beloica J., Đukić V., Belanović Simić S.	SOIL CARBON ACCUMULATION AS A RESPONSE TO THE AFFORESTATION METHOD USED IN THE GRDELICA GORGE IN SOUTHEASTERN SERBIA	104-116
Nikić Z., Ristić R., Letić Lj., Anđelić M., Mrvaljević V.	MUTUAL RELATION OF RIVER WATER AND GROUNDWATER IN THE AREA OF HYGROPHILIC FORESTS IN THE RAVNI SREM DOWNSTREAM OF SREMSKA MITROVICA, SERBIA	117-126
Krstić M., Tomašević Veljović J., Kanjevac B.	A CONTRIBUTION TO THE HUNGARIAN AND TURKEY OAK SITE DEFINING IN CENTRAL SERBIA	127-133
Spasojević B., Čokeša V., Jović Đ., Stanković D.	ANALYSIS OF GROWTH, INCREMENT AND VOLUME OF DOMINANT TREES OF EASTERN WHITE PINE AND DOUGLASS-FIR ON SITE OF SESSILE OAK	134-143
Devetaković J., Mitrović B., Milosavljević M., Nonić M., Stanković D.	EUROPEAN WHITE ELM: POTENTIAL FOR WETLANDS REFORESTATION	144-148

Andrašev S., Rončević S., Bobinac M.	EARLY EFFECTS OF THINNING IN PLANTATION OF EASTERN COTTONWOOD (<i>POPULUS DELTOIDES</i> BARTR. EX MARSH.), CLONE BORA ON THE SAVA RIVER ALLUVIUM	149-158
Bilir N., Gulcu S.	GENERAL OVER-VIEW OF FOREST ESTABLISHMENT IN TURKISH FORESTRY	159-163
Rahman M.S., Tsitsoni T., Tsakaldimi M., Ganatsas P.	FIELD PERFORMANCE OF <i>FRAXINUS ORNUS</i> BAREROOT PLANTS TO DROUGHT STRESS	164-174
Popović J., Suzana M., Milorad V., Dragica V.	IMPACT OF SOIL TO DIMENSIONS OF MECHANICAL FIBRES OF A JUVENILE WOOD OF <i>PAULOWNIA ELONGATA</i> S.Y.HU.	175-184
Jović G., Dukić V., Maunaga Z., Stajić B., Cvjetković B., Subotić J.	PERSPECTIVES OF AUSTRIAN PINE PLANTED FOREST IN THE FOREST MANAGEMENT AREA "TESLIĆ" (BOSNIA AND HERZEGOVINA)	185-193
Djukić M., Djunisijević Bojović D., Grbić M., Marković M., Skočajić D.	PHYSIOLOGICAL VITALITY OF NORWAY SPRUCE SEEDLINGS ON REFORESTED AREA AT MT. KOPAONIK IN SERBIA	194-200
Coello-Gomez J., Fuentes-Boix C., Pique M.	INNOVATIVE SOIL CONDITIONING AND MULCHING TECHNIQUES FOR FOREST RESTORATION IN MEDITERRANEAN CONDITIONS	201-210
Yoshida M., Fujiwara M., Sakai H.	A PROPOSAL OF A SITE PREPARATION SYSTEM COMBINED WITH CHIPPING OPERATION	211-216
Marras T., Canali F., Vessella F., Schirone B.	LIGHT NEEDS FOR SEED GERMINATION AND EARLY DEVELOPMENT OF SEEDLINGS IN CORK OAK (<i>QUERCUS SUBER</i> L.)	217-226
Ortolani M.R., Schirone A., Camillotti G., Schirone B.	AERIAL REFORESTATION BY SEED BOMBS	227-233
Keča Lj., Pajić S.	COSTS AND REVENUES IN POPLAR PLANTATIONS ESTABLISHED USING FULL GROUND AND SOIL PREPARATION IN SERBIA	234-241
Rebić M., Vilotić D., Andrašev S., Rončević S.	THE INFLUENCE OF PLANTING DENSITY ON THE STRUCTURE QUALITY OF THREE TYPE 1/1 CLONES OF EASTERN COTTONWOOD (<i>POPULUS DELTOIDES</i> BARTR. EX MARSH) PLANTED ON THE FLUVISOL SOIL TYPE	242-250
Cvjetković B., Mataruga M., Šijačić-Nikolić M., Daničić V., Lučić A	BUD BURST AND HEIGHT INCREMENT OF NORWAY SPRUCE (<i>PICEA ABIES</i> KARST.) IN PROGENY TESTS IN BOSNIA AND HERZEGOVINA	251-259
Nikolić B., Ristić M., Janačković P., Novaković J., Šarac Z., Rajčević N., Marin P.	VARIABILITY OF THE TERPENIC PROFILE OF <i>PINUS HELDREICHII</i> POPULATIONS OF THE SCARDO-PINDIC (SERBIA-KOSOVO AND REPUBLIC OF MACEDONIA) AND DINARIC MASSIFS (MONTENEGRO AND SERBIA)	260-265
Nonić M., Heinze B., Mengl M., Devetaković J., Slunsky R.	INTRA-POPULATION GENETIC DIVERSITY OF BEECH IN NORTHEAST SERBIA ASSESSED BY MICROSATELLITE MARKERS	266-275
Bobinac M., Andrašev S., Perović M., Bauer-Živković A., Jorgić Đ.	GROWTH ELEMENTS OF ITALIAN ALDER (<i>ALNUS CORDATA</i> /LOISEL./ DESF.) TREES - POTENTIALLY APPLICABLE SPECIES IN SERBIA	276-281
Nikolić B., Ristić M., Janačković P., Novaković J., Šarac Z., Rajčević N., Marin P.	ESSENTIAL OIL COMPOSITION OF ONE-YEAR-OLD BOSNIAN PINE NEEDLES	282-287

Popović V., Šijačić-Nikolić M., Ristić D.	VARIABILITY OF MORPHOMETRIC CHARACTERISTICS OF SEED AND HEIGHT OF ONE-YEAR-OLD SEEDLINGS OF DIFFERENT POPULATIONS OF BEECH (<i>FAGUS MOESIACA</i> /DOMIN, MALY/CZECZOTT) IN SERBIA	288-295
Popović V., Ćirković-Mitrović T., Lučić A., Rakonjac Lj.	CONTAINER TYPE AS A FACTOR OF GROWTH AND DEVELOPMENT OF PEDUNCULATE OAK (<i>QUERCUS ROBUR</i> L.) SEEDLINGS	296-301

PREFACE

The International Conference on Reforestation Challenges was an opportunity for scientists to gather and present results and relate experiences from research areas relevant to reforestation. Top researchers from Europe and North America have been designated as invited speakers. Conference objectives were to provide an opportunity for dynamic and ongoing cooperation between researchers, and to present results of the conference in a thematic publication covering all aspects of the reforestation process. The conference presentations filled the gaps in knowledge regarding successes and failures in reforestation practices. Overall, the Conference highlighted challenges of reforestation and provided some solutions, by contribution to interactions between researchers and practitioners. All researchers, and particularly young ones, got additional support and opportunity to exchange information and to build their research network and collaborative abilities.

The event was dedicated to celebrate the 95th anniversary of Faculty of Forestry – University of Belgrade. Total of 68 participants from 17 countries and three continents (Asia, Europe and North America) attended the conference.

The conference consists of five keynote speech and 94 contributions that covered a wide range of reforestation issues. The presentations were given in six sessions: 1) Planning and management of reforestation programs; 2) Stocktypes and seedlings quality; 3) Monitoring reforestation successes; 4) Planting and seedling-site interaction; 5) Species, intra-species and seed source selection and 6) Plant health in nurseries and plantations.

The book of abstracts was published prior the conference. A total of 94 abstracts with 215 authors from 20 countries were accepted.

Naturally, the strongest took the largest share of the burden. We are therefore particularly grateful to Steven Grossnickle, Anders Mattsson and Kasten Dumroese for reviews of the largest number of contributions. We also thank to the other members of the Scientific Committee. Special thanks go to members of the Organizing Committee for their performance prior and during the Conference.

Vladan Ivetić

Conference Chair

KEYNOTE SPEAKERS

REFORESTATION IN SERBIA: SUCCESS OR FAILURE?

Ivetić Vladan

E-mail: vladan.ivetic@sfb.bg.ac.rs

Ivetić V. (2015). Reforestation in Serbia: Success or failure? In: Ivetić V., Stanković D. (eds.) Proceedings: International conference Reforestation Challenges. 03-06 June 2015, Belgrade, Serbia. Reforesta. pp. 1-12.

Abstract: Forests in the Republic of Serbia cover 2,252,000 ha, 29% of the country's area. Reforestation is, however, small-scale despite strategic documents encouraging more forest cover. From 2004-2013, annual reforestation and afforestation averaged 1,671 and 1,901 ha, respectively, mostly because of reduced investment in forestry. Because funding is limited, reforestation success, mainly measured by seedling survival, is imperative.

For the last 25 years, no organized monitoring of reforestation occurred in Serbia. To better understand current reforestation success, the first-year survival was measured after planting on 90 sites for nine of the most used species in Serbian reforestation programs. Effects of reforestation goal, species, stocktype, planting time, and weather conditions on survival were analyzed. In addition, on 25 of those sites, survival was monitored for five species for another 1, 2, or 3 years on 6, 7, and 12 sites, respectively. The reasons for seedling mortality were identified on 10 sites.

Average first-year survival was 78%, ranging from 85% in assisted natural regeneration to 68% in afforestation, and was strongly influenced by planting goal, species and stocktype selection, and weather conditions. Bareroot (2+0) *Pseudotsuga menziesii* seedlings had the highest survival (90%) whereas bareroot (2+0) *Pinus nigra* seedlings had the lowest (59%). Moreover, *P. menziesii* seedlings maintained high survival on three sites after four years, decreasing slightly from 87% to 82%. In contrast, bareroot (1+0) *Acer pseudoplatanus* seedlings had good first-year survival (~80%) that decreased to 25% on three sites after two years and 21% on four sites after four years. Overall, the lowest average survival rate (61%) was recorded in 2011 when growing season precipitation was only 65% of the normal 30-year average. The two most common reasons for mortality after outplanting were wildlife (54%) and improper planting (21%). Of the dead seedlings, 5% showed no evidence of root penetration into natural soil.

Key words: reforestation, afforestation, seedling survival, seedling mortality, stocktype

INTRODUCTION

In the last two centuries, forest cover in central Serbia is significantly decreased (Figure 1), from 80% in 1801 to 21.4% just after the Second World War (Aleksić and Vučićević 2006). From this lower point, forest cover rate increasing in the second half of XX century, mainly due to improved forest management, successful reforestation and

large afforestation programs. Today, forests in the Republic of Serbia cover 2,252,000 ha, 29.1% of the country's area: 37.6% in Central Serbia and 7.1% in Vojvodina (Banković et al. 2009).

In Serbian forestry, planted forests (Ivetić and Vilotić 2014) are traditionally described as forest cultures or artificial established forests. Young forest, established by afforestation or reforestation (by reconstitution or substitution) is described as forest culture (Ivkov 1971, Stilinović 1991). Planting trees on land without forests is usually described by term of afforestation and planting or direct sowing of trees inside forests or on clear area immediately after harvesting is usually described by term of artificial regeneration or reforestation. Statistical Office of the Republic of Serbia in methodology for survey of forest cover recognize "artificial forests" in forests (after harvesting or on other suitable sites) and outside forests (rocks and barren land, sand, salt marsh, eroded soil, agricultural soil and other soil) both with planting of seedlings or seed sowing.

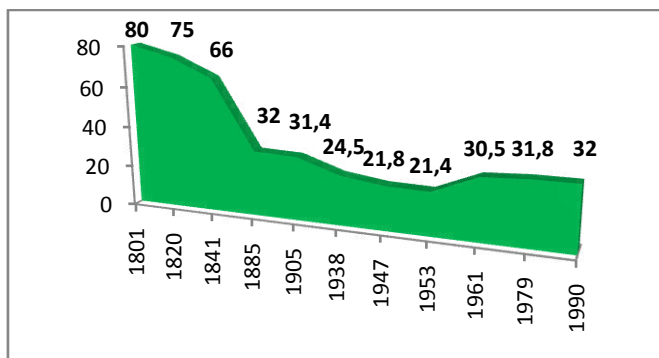

Figure 1. Forest cover rate in Serbia in XIX and XX century (adapted from Aleksić and Vučićević 2006)

Despite strategic documents encouraging more forest cover, in last three decades the reforestation is small-scale. In this paper the focus will be on: 1) reforestation, as artificial forest regeneration by planting seedlings following harvest and 2) afforestation, as way of increasing forest cover and method of restoring forests after deforestation (Stanturf et al. 2014). From 2004-2013, annual reforestation and afforestation averaged 1,671 and 1,901 ha, respectively (Table 1), mostly because of reduced investment in forestry. In same time, annual averages of 6,244,700 seedlings were planted for reforestation/afforestation. In addition, 2,115,900 seedlings were used for industrial plantations and agroforestry. In observed ten year period, the largest total planted area was in 2007, given to largest funding through National Investment Plan.

Because funding is limited, reforestation success, mainly measured by seedling survival, is imperative. Reforestation success can be defined on different fashions, from first-year survival, up to providing a profit or social and environmental benefits. In this study, success of reforestation was measured by survival rate in establishment phase (Kanowski and Catterall 2007).

PROCEEDINGS
International Conference **REFORESTATION CHALLENGES**
03-06 June 2015, Belgrade, Serbia

Table 1: Reforestation/afforestation (ha) in Republic of Serbia, years 2004-2013*.

	Total reforestation/ afforestation	Reforestation	Afforestation	Filling Industrial plantations	Agroforestry	
2004	2.917	1.977	940	609	1.253	139
2005	2.746	1.748	998	321	1.341	119
2006	4.783	2.188	2.595	473	1.577	83
2007	10.475	1.128	9.347	209	7.365	73
2008	3.320	2.446	874	535	8.014	348
2009	2.143	1.018	1.125	309	923	348
2010	2.154	1.305	849	237	5.239	223
2011	2.821	1.834	987	240	6.547	579
2012	2.168	1.413	755	416	866	220
2013	2.194	1.651	543	259	1.149	140
Σ	35.721	16.708	19.013	3.608	34.274	2.272

*Source: Statistical Office of the Republic of Serbia – Bulletin: Forestry in Republic of Serbia, release 2004-2013.

Many reforestation failures are hard to explain with data available. Reforestation failure can be result of some nursery operations, mishandling from lifting to planting (McKay 1997, Grossnickle and South 2014), improper planting technique (South 2000), site conditions and absence of seedling adaptation.

For the last 25 years, no organized monitoring of reforestation occurred in Serbia. The last organized survey of reforestation and afforestation success was done by Stilinović (1987). So, this research has two goals: 1) to measure reforestation and afforestation success in Serbia by means of survival rate and 2) to initiate a setup of organized monitoring on long term.

MATERIAL AND METHODS

The first-year survival after planting was measured on total of 90 sites, in a five-year period (2010-2014). The data were collected from forest enterprises (Stolovi, Niš, Južni Kučaj and Belgrade) in system of PE “Srbijašume” (Figure 1). In addition, on 25 of those sites, survival was monitored for five species for another 1, 2, or 3 years on 6, 7, and 12 sites, respectively.

The reasons for seedling mortality were identified on 10 sites. A one sample plot (10 m wide x 50 m long) per hectare was established and obvious reasons for seedling mortality or damage were recorded. Seedlings without visible cause of death were lifted-out for morphological examination.

Mortality was attributed to poor seedling quality in case of absence of growth (shoot and root) and in case of significant deformations. Improper planting was defined by poor planting spot preparation (depth) and wrong seedling positioning. Mortality by wildlife was differentiated from mechanical damage by symptoms of grazing. Dead, wilted plants with yellow or brown leaves and needles, appearing throughout the site are attributed to drought (Figure 1).



Figure 1: Mortality by wildlife (left), improper planting (center) and mortality by drought (right)

Effects of reforestation goal, species, stocktype, planting time, and weather conditions on survival were analyzed. Weather conditions (air temperature and precipitation) were collected for the research period (Table 2).

Table 2: Weather conditions in growing season (April-September) years 2010-2014

Year	Temperature deviation* (°C)	Days with temp. >20°C	Days with temp. >30°C	Days with temp. >35°C	Rainy days	Precipitation (mm)	Precipitation percentage of normal average*
2010	1.1	136	32	2	58	467	129
2011	1.5	149	47	8	38	239	65
2012	2.4	150	68	19	39	279	77
2013	1.2	146	41	8	46	305	84
2014	0.7	136	17	0	70	698	190

*from normal average values for the period 1971-2000.

RESULTS

The first-year survival was measured on 90 sites, with total of 340 ha. During years 2010-2014, the average first-year survival was 78%, ranging from 87.5% in 2014 to 60.8 in 2011 (Table 3).

Table 3: Survival in first year after planting in period 2010-2014

Year	Number of sites	Average site area (ha)	Survival (%)
2010	21	3.97	79.8
2011	16	3.12	60.8
2012	18	3.07	75.7
2013	17	4.12	84.6
2014	18	4.52	87.5
AVERAGE			77.7

Based on reforestation goal, average first-year survival range from 85.6% in assisted natural regeneration to 68% in afforestation. The most successful was assisted natural regeneration, with first-year survival of 80-90% (Table 4). In same time, some

PROCEEDINGS

International Conference **REFORESTATION CHALLENGES**

03-06 June 2015, Belgrade, Serbia

serious failures were recorded in amelioration (first-year survival of 30%) and total failures in reforestation after fire and afforestation (5% and 0% respectively).

Table 4: Reforestation goal and survival rate

Reforestation goal	Total area (ha)	Average area (ha)	Survival (%)	Min	Max
After fire	172.47	4.79	74.8	5*	90
Amelioration	96.57	3.58	80.6	30	95
Assisted natural regeneration	35.15	5.02	85.6	80	90
Afforestation	35.81	3.26	67.9	0***	90**

* *Pinus nigra*, 2+0 bareroot

** *Acer pseudoplatanus*, 1+0 bareroot

*** *Pinus nigra*, 2+0 container

Table 5: The first-year survival of seedlings in reforestation after fire, by species and stocktype

Species	Reforested area (ha)	Stocktype	Age	Survival (%)
<i>Pseudotsuga menziesii</i>	2.62	Bareroot	2+0	90
<i>Pinus nigra</i>	71.3	Container	2+0	66.22
	1.45	Container	3+0	87.5
	8.7	Bareroot	2+0	59.16
<i>Acer pseudoplatanus</i>	10.80	Bareroot	1+0	75.27
<i>Robinia pseudoacacia</i>	2.18	Bareroot	1+0	85
<i>Picea abies</i>	13.74	Plug+2	2+2	73
	21.77	Bareroot	2+1	87.5
<i>Acer heldraichii</i>	29.98	Bareroot	1+0	85.83
<i>Prunus avium</i>	6.1	Bareroot	1+0	85
<i>Quercus petraea</i>	2	Bareroot	1+0	85
<i>Fraxinus excelsior</i>	2	Bareroot	1+0	85
STOCKTYPE				
Bareroot				81.97
Container				76.86
Plug+2				73

The average first-year survival in reforestation after fire range from 90% (bareroot 2+0 *Pseudotsuga menziesii*) to 59% (bareroot 2+0 *Pinus nigra*). In most cases bareroot seedlings were used, except for *Pinus nigra*, which container seedlings survived better than bareroot. In general, bareroot seedlings survived better (Table 5).

The first-year survival in melioration ranges from 91% (container 2+0) to 65% (bareroot 2+0) both *Pinus nigra* seedlings (Table 6). Similar results were recorded for *Picea abies*, both bareroot seedlings, but survival ranged from 90% (2+2) to 66% (3+0). Container seedlings had the highest, while bareroot and Nisula seedlings had a similar survival rate.

The first-year survival in assisted regeneration ranges from 90% (bareroot 2+0, *Acer pseudoplatanus*) to 82.5% (bareroot 1+0 *Acer heldraichii*) (Table 7). Only bareroot seedlings were used.

PROCEEDINGS
International Conference **REFORESTATION CHALLENGES**
03-06 June 2015, Belgrade, Serbia

Table 6: The first-year survival of seedlings on reforestation for melioration, by species and stocktype

Species	Reforested area (ha)	Stocktype	Age	Survival (%)
<i>Picea abies</i>	17.01	Bareroot	3+0	66.25
	2.43	Bareroot	2+2	90
	18.74	Nisula	2+1	81.25
	1.12	Nisula	2+2	75
<i>Pseudotsuga menziesii</i>	5.52	Bareroot	2+0	80
<i>Quercus petraea</i>	5.50	Bareroot	1+0	88.33
<i>Pinus nigra</i>	10.59	Container	2+0	90.83
	4.21	Bareroot	2+0	65
<i>Acer heldraichii</i>	16,64	Bareroot	1+0	87.5
<i>Prunus avium</i>	6.03	Bareroot	1+0	87.5
STOCKTYPE				
Bareroot				80.65
Container				90.83
Nisula				78.12

Table 7: The first-year survival of seedlings after assisted natural regeneration, by species and stocktype

Species	Reforested area (ha)	Stocktype	Age	Survival (%)
<i>Acer pseudoplatanus</i>	2.17	Bareroot	2+0	90
	1,00	Bareroot	1+0	85
<i>Pinus nigra</i>	16.04	Bareroot	3+0	86.2
<i>Acer heldraichii</i>	13.94	Bareroot	1+0	82.5
<i>Prunus avium</i>	2	Bareroot	1+0	85
STOCKTYPE				
Bareroot				85.6

Table 8: The first-year survival of seedlings after afforestation, by species and stocktype

Species	Reforested area (ha)	Stocktype	Age	Survival (%)
<i>Pinus nigra</i>	4.86	Container	2+0	29.2
	3	Bareroot	2+0	80
	4	Bareroot	3+0	87.5
<i>Picea abies</i>	9.65	Bareroot	2+1	83.7
<i>Acer pseudoplatanus</i>	5.3	Bareroot	1+0	75
<i>Acer heldraichii</i>	6	Bareroot	1+0	87.5
STOCKTYPE				
Bareroot				82.74
Container				29.2*

*87.5% with two total failures excluded.

The first-year survival in assisted regeneration ranges from 87.5% (bareroot 3+0 *Pinus nigra* and bareroot 1+0 *Acer pseudoplatanus*) to 29.2% (container 2+0 *Pinus nigra*).

The average survival after afforestation of bareroot seedlings was 82.74% (Table 8). So low average survival rate of container 2+0 *Pinus nigra* seedlings is due to total failure on two sites (0%) planted on 2011. If we exclude these two outliers, average first-year survival of container 2+0 *Pinus nigra* seedlings is 87.5%.

Table 9: The first-year survival of seedlings by stocktype

Stocktype	Number of sites	Area (ha)	The first-year survival (%)
Bareroot	66	215.23	80.3
Container	19	104.1	73.1
Nisula	6	19.86	79.2

In general, bareroot seedlings are the most used stocktype in Serbian reforestation and afforestation programs. Bareroot seedlings had the highest survival rate (80.3%) followed by Nisula and container seedlings, with 79.2% and 73.1% respectively (Table 9).

Table 10: The first-year survival of seedlings by time of planting

Time of planting	Number of sites	Area (ha)	Survival (%)
Spring	47	93,79	71.29
Autumn	43	73.38	73.93

Planting on spring and autumn are equally distributed by the number of sites. The time of planting have no influence on average first-year survival (Table 10).

Table 11: Survival in the first and in following years at 25 sites

Species	Number of sites	Reforested area (ha)	Stocktype	Age	First year survival (%)	Survival in years after planting
Four years after planting						
<i>Picea abies</i>	1	2.43	Bareroot	2+2	90	70
<i>Pseudotsuga menziesii</i>	3	4.72	Bareroot	2+0	86.67	81.67
<i>Pinus nigra</i>	3	7.7	Container	2+0	87.5	56.67
	1	1.45	Container	3+0	87.5	70
<i>Acer pseudoplatanus</i>	4	5.80	Bareroot	1+0	80.62	21.25
Three years after planting						
<i>Picea abies</i>	2	9.67	Bareroot	2+1	90	50
<i>Quercus petraea</i>	2	3.5	Bareroot	1+0	90	62.5
<i>Pinus nigra</i>	1	0.3	Container	2+0	50	50
<i>Acer pseudoplatanus</i>	2	3.17	Bareroot	1+0	82.5	40
Two years after planting						
<i>Picea abies</i>	2	1.12	Bareroot	2+2	75	60
<i>Pseudotsuga menziesii</i>	1	1.1	Bareroot	2+0	90	90
<i>Acer pseudoplatanus</i>	3	4.3	Bareroot	1+0	76.67	25

PROCEEDINGS
International Conference **REFORESTATION CHALLENGES**
03-06 June 2015, Belgrade, Serbia

In general, survival of all species and stocktypes decreased in year's two to four after planting (Table 11). This decrease in survival is larger for bareroot seedlings. *Pseudotsuga menziesii* bareroot (2+0) seedlings maintained high survival on three sites after four years, decreasing slightly from 87% to 82%. In contrast, bareroot (1+0) *Acer pseudoplatanus* seedlings had good first-year survival (~80%) that decreased to 25% on three sites after two years and 21% on four sites after four years.

Table 12: The reasons of seedling mortality on 10 sites

Species	Stocktype	Age	Number of				Number of dead seedlings by				
			site	SP	seedlings	Dead seedlings	Poor seedling quality	Wildlife	Improper planting	Mechanical damage	Extreme weather
<i>Pinus nigra</i>	Container	2+0	2	4	500	210	5	111			94
<i>Fraxinus excelsior</i>	Bareroot	1+0	4	12	1500	420	35	296	89		
<i>Acer heldraichii</i>	Bareroot	1+0	2	3	375	67			31	36	
<i>Quercus petraea</i>	Bareroot	1+0	2	4	500	195	33	75	65		22
TOTAL			10	23	2875	892	73	482	185	36	116
PERCENTAGE*							8.18	54.03	20.74	4.03	13.00

SP – sample plots
* of dead seedlings

The two most common reasons for mortality after outplanting were wildlife (54%) and improper planting (21%). Of the dead seedlings, 5% showed no evidence of root penetration into natural soil. On 10 sites, extreme weather events caused damages mostly by frost (Table 12).

DISCUSSION

After the Second World War forest cover rate in Serbia is increased, mainly due to improved forest management, successful reforestation and large afforestation programs. However, not all of these programs of reforestation and afforestation were successful. Although Ratknić and Dražić (2007) states 525,657 ha afforested/reforested in Serbia between 1945-1995 (492,256 ha in Central Serbia and Vojvodina) and Ranković (2009) states 390.965 ha between 1961-2007, according to National Forest Inventory planted forests covers only 174,800 ha or 7.8% of total forest area in Serbia; of which 6.1% are cultures and 1.7% of plantations (Banković et al. 2009). So, the question is: What was happened to these large areas of planted forests? Reasons for such large mismatch are numerous: different definitions of planted forests and survey methodologies, rotation of some stands is finished and they are naturally regenerated, as well as reforestation failure. In many cases, repeated planting following planting failure and low survival rate, are recorded as new planting, resulting with unduly increase of planted area. Origin of forest stands in last National Forest Inventory was determined (among others) on tree species and regeneration method. Based on field survey, stands were classified as high forests,

coppice forests or artificial established forests. Some differences may be due to fail of recognizing the stand origin.

Average survival rate of 78% in five years period on 90 planting sites is not satisfactory, but this is the result of diverse species, reforestation goals, site conditions and weather. Reasons for planting success or failure in Serbia are numerous: site, species (and provenance) selection, nursery operations, stocktype and seedling quality, handling after lifting from bed or container, organization of planting, site preparation, planting technique, silviculture after planting (Stilinović et al. 1987). The reasons for mortality on researched sites are hard to explain with data available, but some general trends can be observed.

There is obvious effect of weather conditions on seedling survival in the first year after planting. The hottest year in observed period was 2012, with 2.4° C above normal average and the most days with temperatures above 30° C and 35° C, resulting with survival rate of 76%. However, effect of precipitation to survival is stronger compared to air temperature. The lowest survival rate was in year 2011, with precipitation of 65% of normal average (from period 1971-2000). On the other hand, the highest survival rate was in year 2014, with precipitation of 190% of normal average.

The planting goal had a strong influence on the first-year survival rate. The most successful was assisted natural regeneration, followed by melioration and reforestation after fire. This trend of reduced survival rate from assisted natural regeneration to afforestation can be expected, due to changing of environmental conditions. The lowest survival rate was in afforestation, which is expected due to harsh environment on the most of the planting sites. However, this low survival rate (67.9%) is due to two total failures of *Pinus nigra* (2+0 container) seedlings, planted in year 2011, the driest year in observed period. The lack of precipitation, combined with poor site preparation can be the reason of total failure on these sites. If we exclude these outliers, the average survival rate in afforestation is 83% which indicate that planting on non forest land can be successful when site preparation, the good quality seedlings and a proper planting technique are applied.

It is interesting that *Pseudotsuga menziesii* as introduced species have the highest first-year survival rate on reforestation after fire and maintained high survival two and four years after planting. These results indicate that this species is well adapted to new environment. *P. menziesii* is introduced to Serbia very late, at beginning of XX century (Soljanik 1968). Provenance test of reproductive material from 29 provenances which covers the most of the natural range of *P. menziesii* in North America is established in eastern Serbia (Šijačić-Nikolić et al. 2014). According to National Forest Inventory (Banković et al. 2009), *P. menziesii* counts 1,600,000 trees in Serbian forests with total of 511,150 m³ of wood. Despite growth which usually overcomes the growth of other local or other introduced species (Marković 1950, Radulović 1960, Stojanović et al. 2010) and good results in provenance trial, in last 10 years (2005-2014) the new cultures of *P. menziesii* was established only on total of 137 ha.

In general, bareroot seedlings are the most used stocktype in reforestation and afforestation programs in Serbia. The lower survival of container seedlings, compared to other stocktypes is not expected. Container seedlings have a higher survival in a

predominant number of trials (reviewed by Grossnickle and El-Kassaby 2015 – 122 trials). Results of this study show average survival rate of container seedlings on 19 sites of 73% (two total failures excluded). Since site preparation and even planting spot preparation are very similar for bareroot and container seedlings in Serbian forestry practice, this poor survival of container seedlings can be attributed to inappropriate nursery operations. The quality of container seedlings is not defined by current Serbian standard. Beside two container nurseries equipped with newest technology, the most are still growing seedlings in old designed containers with trays old between 20-30 years. Recommendations for substrate preparation, fertilization and irrigation are only general. Additional research should be conducted to found the reasons of such poor survival of container seedlings. Planting seedlings with desirable plant attributes increases chances for survival after field planting (Grossnickle 2012) and improvement of nursery operations can lead to increased survival at field.

Planting is equally distributed in two seasons – spring and autumn, with hardwoods planted in both seasons and conifers planted mainly in spring. The absence of influence of planting time in this study was similar to previously reported (Stilinović 1991, Repáč et al. 2011).

Reducing of survival rate in years after planting is worrying. Seedlings face the greatest obstacles to survival in the first year after planting (Burdett 1990, Grossnickle 2005) and their survival in following few years depends a lot on control of competing vegetation and protection from browsing. On some sites a severe damage from browsing was recorded and vegetation control was poor on large portion of planting sites. The largest reduction of survival rate in years two to four after planting was recorded in years 2011-2012, and this mortality can be attributed to drought.

Wildlife caused a half of mortality at 10 sites. These damages can be easily avoided by wildlife control and protecting from browsing. Unfortunately, there was no use of repellents, fences or tree shelters at researched planting sites. Improper planting is another reason of high mortality on planting sites which can be eliminated. Planting technique can seriously affect survival, with shallow planting as one of the most obvious reasons for seedling dying. In addition to training of planting crew, the quality control of all activities on planting site needs to be improved. On some sites planting was accepted by forestry authorities despite obvious mistakes in planting spot preparation and seedling positioning. Immediate repeating of planting is much cheaper than corrective activities in following years. On 10 sites, only 13% of mortality was attributed to drought. This result can mislead to wrong conclusion because this part of the study was conducted in 2014 – year with the precipitation almost double to the normal average.

CONCLUSION

Historically, reforestation and afforestation in Serbia after the second half of XX century can be considered as success. The increase in country's forest cover rate of 8% is equal to area of planted forests. In last five years (2010-2014) reforestation was on small-scale and average first-year survival of 78% cannot be considered as success. The lowest survival rate was recorded in year with least precipitation. Many reasons of reforestation

failures can be easily eliminated with improvement of planting technique and silviculture after planting. The constant survey of reforestation success is necessary to provide backward information's to nursery managers and forest contractors on planting how to improve their activities and performance.

REFERENCES

- Aleksić P., Vučićević S. (2006). Šumovitost Srbije. Šumarstvo br. 3, Beograd (177-184).
- Banković S., Medarević M., Pantić D., Petrović N., Šljukić B., Obradović S. (2009). The growing stock of the Republic of Serbia - state and problems. Bulletin of the Faculty of Forestry 100: 7-30.
- Burdett A.N. (1990). Physiological processes in plantation establishment and the development of specifications for forest planting stock. Canadian Journal of Forest Research 20: 415-427.
- Grossnickle S.C. (2005). Importance of root growth in overcoming planting stress. New Forests 30: 273-294.
- Grossnickle S.C. (2012). Why seedlings survive: Importance of plant attributes. New Forests 43: 711-738.
- Grossnickle S.C., El-Kassaby Y.A. (2015). Bareroot versus container stocktypes: a performance comparison. New Forests. (Published online: 10 March 2015).
- Grossnickle S.C., South D.B. (2014). Fall Acclimation and the Lift/Store Pathway: Effect on Reforestation. The Open Forest Science Journal 7: 1–20.
- Hobbs SD (1992). Seedling and site interactions. In: Reforestation practices in southwestern Oregon and northern California (SD Hobbs ed.). Forest Research Laboratory, Oregon State University, Corvallis, OR, USA. pp. 114–135.
- Ivetić V., Vilotić D. (2014). The role of plantation forestry in sustainable development. Bulletin of the Faculty of Forestry: 157-180.
- Ivkov R. (1971). Šumske culture I plantaže – tehnika podizanja I gajenja – II neizmenjeno izdanje. Naučna knjiga, Beograd. 128 p.
- Kanowski J., Catterall C. P. (2007). Monitoring Revegetation Projects for Biodiversity in Rainforest Landscapes. Toolkit Version 1, Revision 1. Marine and Tropical Sciences Research Facility, Cairns. 52 p.
- Marković Lj. (1950). Proučavanje razvoja veštački podignutih sastojina nekih vrsta četinarara na Avali. Radovi Instituta za naučna istraživanja u šumarstvu Srbije. [In Serbian, summary on English]. Knj. I, Beograd 1950.
- McKay H.M. (1997). A review of the effects of stresses between lifting and planting on nursery stock quality and performance. New Forests 13: 369–399.
- Radulović S. (1960). Douglas fir in the light of its development on the mount Avala. [In Serbian: Duglazija u svetlosti podataka njenog razvoja na Avali, summary on English]. Šumarstvo, XIII (9-10); 415-424.
- Ranković N. (2009). Afforestation in Serbia in the period 1961-2007 with special reference to Austrian pine and Scots pine. Bulletin of Faculty of Forestry 99: 115–134. [In Serbian].
- Ratknić M., Dražić M. (2007): Pošumljavanje goleti. In: Ratknić M., ed. (2007): Pošumljavanje goleti I antropogeno oštećenih zemljišta. Monografija, Institut za šumarstvo, Beograd. 5-22
- Repáč I, Tučeková A, Sarvašová I, Vencurik J (2011a). Survival and growth of outplanted seedlings of selected tree species on the High Tatra Mts. windthrow area after the first growing season. Journal of Forest Science 57: 349-358.

- Šijačić-Nikolić M., Milovanović J., Nonić M. (2014). Forest genetic resources in Serbia - state and recommendations for improvement in this area. [In Serbian, summary on English]. Bulletin of the Faculty of Forestry: 51-70.
- Soljanik I. (1968). About the cold resistance of douglas fir (*Pseudotsuga taxifolia* var. *viridis* Asch, et Gr.) in Kosmet. [In Serbian, summary on English]. Šumarski list (3-4): 112-121.
- South D. (2000). A Review of the Pull up and Leave down Methods of Planting loblolly pine. School of Forestry and Wildlife Sciences of Alabama, 26 pp.
- Stanturf J.A., Palik B.J., Dumroese R.K. (2014). "Contemporary forest restoration: A review emphasizing function." Forest Ecology and Management 331: 292-323.
- Stilinović S. (1987). The determination of causes for failure and drying of forest cultures with proposal of measures for their elimination. RSIZ for Forestry of Serbia, Belgrade, Serbia. 287 pp. [In Serbian]
- Stilinović S. (1991). Afforestation. Naučna knjiga, Belgrade. University book. 274 p. [In Serbian]
- Stojanović Lj., Krstić M., Bjelanović I. (2010). Stand state and silvicultural operations in the plantations of larch, Douglas-fir and weymouth pine in the territory of Majdanpečka domena. Šumarstvo (1-2): 1-12.

Session 1:

**PLANNING AND MANAGEMENT OF REFORESTATION
PROGRAMS**

THE REPUBLIC OF SERBIA'S AFFORESTATION STRATEGY WITH AN ACTION PLAN

**Ratknić Mihailo, Rakonjac Ljubinko, Braunović Sonja, Miletić Zoran,
Ratknić Tatjana**

Ratknić M., Rakonjac Lj., Braunović S., Miletić Z., Ratknić T. (2015). The Republic of Serbia's afforestation strategy with an action plan. In: Ivetić V., Stanković D. (eds.) Proceedings: International conference Reforestation Challenges. 03-06 June 2015, Belgrade, Serbia. Reforesta. pp. 13-22.

Abstract: By setting the objective of increasing the Republic of Serbia's forest cover to 41.4% by 2050, the Serbian forestry has undertaken a number of tasks, among which afforestation, regeneration and the improvement of quality of the existing forests have the highest priority. The key criteria applied in the prior afforestation of barren land, as well as in amelioration of degraded and coppice forests were the scope of afforestation, i.e. the size of afforested areas and the highest possible wood mass yield, obtainable in a short period. That was attained by a selection of species, frequently not in their ecological optimum at the forest sites subject to afforestation. The objective of the Republic of Serbia's Afforestation Strategy is to provide a professional and scientific scope for establishment of approximately 1,000,000 ha of new forest plantations. That would create the conditions for: enhancement of quality of the environment and protection and rational utilisation of forest and other natural resources; protection of natural processes and preservation of landscape identity; control of land erosion processes and securing the quality of waters; reduction of impact of harmful gases; protection of a species and ecosystem component of biodiversity and preservation of biological diversity, etc. The implementation of new afforestation strategy, based on ecosystem preservation and sustainable development, will contribute to a more successful establishment of cultures and plantations, as well as to enhancement of other, generally beneficial forest functions.

Key words: Serbia, afforestation strategy, generally-beneficial forest functions.

INTRODUCTION

Performance of mass afforestation in Serbia was accompanied by serious mistakes, which occurred as a result of application of poor solutions that produced long-standing effects. After the World War Two, the introduction of foreign species was initiated, mainly from the USA (ailanthus, black locust, false indigo, Douglas-fir, eastern white pine, etc), with the aim of reducing soil erosion. The 'Serbia with no barren land' Strategy, introduced in the 1970's, apart from its undoubtedly positive impact in form of establishing new 200,000 hectares of forest cultures, also enabled formation of large-scale artificial ecosystems.

Today, as a result of such uncritical behaviour, an invasion of black locust has taken place in national parks, nature parks, etc; ailanthus has already become dominant in

certain parts of natural ecosystems, while false indigo sovereignly reins in the forelands of the Danube and its tributaries. Endangerment of natural floodplain forests and plantation of poplar cultivar led to destruction of large areas of natural ecosystems in Serbia. The Red Book of Serbian Flora holds afforestation directly responsible for the extinction of certain vascular plant species. More specifically, at the 'Debeli Lug' Faculty Estate, the afforestation by black pine destroyed the habitat of species *Diphasiastrum complanatum* (L.) J. Holub, the only representative of the family Licopodiaceae in the Serbian flora. Biodiversity centres of global importance (Strešer, Besna Kobila, etc.) were afforested by black and white pine. Rare habitats of endemic and relict species were destroyed in attempts to 'move' the upper vegetation limit by afforestation.

The above-mentioned failures, along with the climate change impact on natural ecosystems, were the reasons for the design of a new Serbian Afforestation Strategy (Ministry of Agriculture, Forestry and Water Management – Forest Administration).

STRATEGY OBJECTIVES, GUIDELINES AND CONCEPT

The objectives of the Serbian Afforestation Strategy are the following: providing professional and scientific scope for establishment of 1,000,000 hectares of new forest plantations and creating conditions for enhancement of environmental quality; protection and rational utilisation of forest and other natural resources; protection of natural processes and landscape identity; controlling land erosion and securing water quality; reducing impact of harmful gas emissions; protection of a species and ecosystem component of biodiversity; preservation of biological diversity, etc. The Afforestation Strategy is harmonised with relevant international treaties and conventions, applicable laws, regulations and the EU policy (Acquis communautaire) in the field of environmental protection and conformed to the laws and regulations of the Republic of Serbia.

Specific objectives of the Afforestation Strategy are the following:

- Implementation of effective organisation in the field of forestry, based on scientific advances and previous domestic and international experiences.
- Development of information system for operational work organisation – production of seedlings from known seedling nurseries (of known provenance) for habitats of known characteristics, along with selection of the optimum method for production of planting material and afforestation technology.
- Encouraging plantation of new and enhancing condition of the existing forests by application of the latest silvicultural measures, aimed at conversion and reconstruction of coppice forests and anthropogenic scrubs into the forests of higher silvicultural form.
- Minimising the conflicts between forestry and other land users.

Forest management planning should aim at preservation, protection and biodiversity increase at the ecosystem, species and genetic level, as well as at the site level. Mapping and drawing up forest resource inventory must include ecologically important habitats, which incorporate protected, rare or sensitive forest ecosystems. Natural regeneration represents the priority. In afforestation, the priority is given to autochthonous species of appropriate provenance (Ratknić et al. 2009).

Tending and felling should be conducted on the basis of nature-friendly management principles, which do not disturb functioning of an ecosystem. Construction of infrastructural facilities must not cause damage to ecosystems (rare and sensitive, in particular) or genetic resources, nor expose to threat habitats of endangered and other important species, nor endanger their migration routes.

For the purpose of reducing deficiencies of the current global climate forecasts, regional climate models and impact models should be used. The results of these models are integrated into activities enabling timely adaptation to climate changes or their mitigation (if possible).

ECOLOGICAL CHARACTERISTICS OF POTENTIAL AFFORESTATION HABITATS

The creation of the Strategy is based on a detailed analysis of habitat ecological characteristics (geological, pedological, climate characteristics, habitat types, erosion condition, etc.), whose understanding is the key to successful afforestation. A particular attention is paid to the following: reaction of forest ecosystems to climate changes; impact of climate changes on biodiversity; impact level and species reaction to climate changes; importance of global climate changes and possibility of creation of new species and subspecies suitable for altered climate conditions; occurrence of weed and invasive species, insects, plant diseases, etc (Ratknić 2008).

The expected effects of climate changes on forest ecosystems, forest communities and tree, shrub and ground vegetation species are the following:

- latitude and altitude boundary shift of certain forest types;
- seen from a long-term perspective, certain communities will probably 'lose the battle' and 'give up the race' and eventually become extinct;
- a different composition of certain plant communities, with respect to multi-storey and social position, involving extinction of some plant communities and emerging of others;
- change of attitude of certain species towards light;
- higher exposure of forest communities to various adverse effects that are a direct or indirect result of climate changes;
- The above-mentioned effects, considered cumulatively, will produce a direct impact on the possibility of biological diversity preservation and the viability of rational management of the resources.

The above-mentioned expected effects determine the potentials, as well as the intensity of sustainable forest management planning.

Based on the Climate Model (Ratknić et al. 2010), it has been established that the total number of forest habitats in Serbia is 210. A 1° C temperature increase would reduce the number of habitats to 198, while a 2° C temperature increase would bring the number of habitats down to 192. A 3° C temperature increase would reduce the number of habitats to 159, while a 4° C temperature increase would bring the number of habitat down to 131. A 5° C temperature increase would reduce the number of habitats to 116, or, by 44.8%.

BIODIVERSITY

It is stipulated by the Strategy that afforestation, in any of its segments, must not endanger ecosystem, species and genetic diversity. Potential afforestation areas must not endanger habitats or species survival, nor cause fragmentation of natural habitats.

Measures and activities aimed at biodiversity protection at species and ecosystem level (national and global interest) include the following:

- biodiversity monitoring and valorisation of condition of diversity centres,
- detection of endemic species, relicts, rare and endangered species and species of international importance, aiming at their more effective protection;
- analysis of natural populations, particularly from the aspect of conservation biology;
- proposal for appropriate measures aiming at preservation of biodiversity in diversity centres, where natural diversity is endangered (*in situ* and *ex situ* conservation).

SELECTION OF AFFORESTATION SPECIES

Only autochthonous tree and shrub species should be used in afforestation and plantation of non-forest greenery. Allochthonous broadleaf and coniferous species may be used solely for establishment of intensive plantations.

It is necessary to prevent spreading and take measures for destruction of invasive tree and shrub species, which disturb natural forest and other ecosystems (*Acer negundo*, *Ailanthus glandulosa*, *Amorpha fruticosa*, *Celtis occidentalis* etc.). In addition, use of allergenic species in the vicinity of inhabited areas should be prevented. Furthermore, in natural or partially-modified natural habitats, use of cultivars and clones should be prevented.

In the selection of afforestation tree species, a broad range of species was provided for each habitat. Principal, accessory and shrub tree species were defined - edifiers of prospective communities on a given area. Revitalisation of forest ecosystems will be achieved also by plantation of forest fruits. 122 fruit species, classified into 23 families and 38 genera, have been identified in Serbia in natural, mostly forest ecosystems. It is assumed that the territory of Serbia is a primary gene centre for most fruit species grown today, which is indicated by their large presence in natural, mostly forest ecosystems.

In the light of all the changes that will occur in future as a result of the impact of climate factor change, the Strategy regards a habitat as the basis for afforestation. The objective is to eliminate the causes of destruction and extinction of certain species and habitats:

- complete destruction of natural habitats and their substitution by secondary or artificial habitats, unfavourable for survival of native primary ecosystem species
- fragmentation of natural ecosystems
- partial interventions that lead to changes of ecosystem structure and function
- excessive exploitation of species
- direct or indirect pollution of water, air and soil
- introduction of allochthonous species of flora and fauna, which leads to composition

change of autochthonous fauna, flora and ecosystems

SEED FACILITIES

According to the data from the Seed Facility Registry (the Republic of Serbia's Ministry of Agriculture and Environmental Protection), the number of seed facilities in Serbia is 310, occupying the area of 2,954 ha, which constitutes 0.095% of the total land area covered by forest. In the seed facilities, 20 tons of seed is collected and 30 million seedlings are produced. Seven million of produced seedlings are broadleaves, while the others are conifers and horticultural species.

In central Serbia, a large number of seed facilities were selected among the best natural populations, for the purpose of providing a sufficient quantity of healthy and selected seed and seedling material, as a form of *in situ* preservation of a population gene pool. 95 coniferous seed facilities have been registered. The largest number of seed stands belongs to Norway spruce (*Picea abies*) - 24, followed by fir (*Abies alba*) - 23, black pine (*Pinus nigra*) - 12, white pine (*Pinus silvestris*) - 11 and Serbian spruce (*Picea omorika*) - 6.

Among broadleaves, the most numerous are seed facilities of species appreciated for their wood mass production (pedunculate oak, sessile oak, beech, etc.); there is also a significant number of allochthonous species, whose seedling material is used for afforestation (Douglas-fir, eastern white pine, cedar, etc.) or production of decorative seedling material (cypress, thuja, sequoia, etc.).

The structure of species represented in seed facilities is not adequate to respond appropriately to habitat changes caused by climate changes; therefore, it is necessary to perform the following activities:

- To determine the adaptability of species and genotypes in given climate conditions, the limits of their mobility, and the development of climate-based seed characteristics in the zones that will change in the course of time (Parker et al. 2000, Ratknić 1999). Provenances should be tested on the boundaries of their ecological range, with understanding of appropriate physiological processes (Tyree 2003).
- To grow specific genotypes resistant to pest and with higher tolerance to climate extremes (Wang et al. 1995).
- To grow forest fruits. Change of climate conditions will result in extinction of certain forest fruits in forest ecosystems. As they represent the basis for normal functioning of ecosystems, genotypes that are resistant to changes should be found (Ratknić 2005).

The forest fruit Seed Facility Registry contains only small part of the entire abundance of the autochthonous Serbian dendroflora. The Strategy envisages amending the Registry by adding populations of autochthonous tree and shrub species with low value in use, as they are also of importance for maintenance of stability and biodiversity of forest communities and ecosystems. Accordingly, those species should be used intensively in reconstruction of potential vegetation. The Strategy does not rely only on resources of state-owned forests, as in some parts of Serbia resources of privately-owned forests are more diverse and abundant in terms of flora.

PRODUCTION OF AFFORESTATION SEEDLING MATERIAL

Nursery production in Serbia is characterised by fragmentation of production areas, insufficient connection between producers of planting material and potential users, frequent absence of necessary morphological-physiological characteristics of seedlings for specific habitats and insufficient representation of broadleaf species. Based on the above-mentioned characteristics of nursery production, seed source values, an increasing demand for planting material, as well as the performed zoning of potential afforestation areas, land amelioration and plantation of special-purpose cultures, it is necessary to direct standard technology towards production of special-purpose planting material. Production of tree and shrub planting material based on the use of seed of recognised provenances and sorts, considerably improves afforestation success, adaptability and productivity of forest cultures.

AFFORESTATION TECHNOLOGY IMPROVEMENT

Halting degradation and reducing degraded land surface area involve application of afforestation technology that guarantees success with low investment (Ratknić 2004). On such terrains, even at short distances, the variability of orographic and pedological characteristics is high, which requires individual planning, for each locality, of seedling material properties, planting technique, planting scheme and number of plants per surface unit.

The criteria of decisive importance for selection of seedling material production technology are the following: seed material genetic quality, seedling cultivation conditions in seedling nurseries and afforestation habitat type. The analysis of ecological characteristics of non-stocked forest land that is planned for afforestation represents the basis for selection of seed of appropriate origin, adequate seedling production technology, preparation of terrain for planting, preparation of planting scheme, performance of planting and several-years long tending and protection method of established cultures.

In afforestation, particularly of eroded terrains, radical changes of potential ecosystems and their main edificators should not be made. As far as it is possible, natural progressive succession should be encouraged by introduction of appropriate, mostly broadleaf species.

ACTION PLAN

Potential afforestation areas

The Strategy suitability classification, based on the system of assessment of soil suitability, has the following structure (FAO 1976):

- suitability order, reflects suitability type;
- suitability class, reflects the suitability degree within an order;
- suitability subclass, reflects type of limitation;
- suitability unit, reflects less relevant differences within subclass.

For decision-making on optimum land use, the following data is necessary:

- Agriculture: soil quality class I-V, area use (cultures);
- Landscapes: national landscape beauty, regionally important landscapes;
- Nature protection: nature reserves, natural monuments, natural memorial monuments, area around immovable cultural monuments, forest parks, natural history collections;
- Recreational activity/tourism: tourist routes, observation points;
- Drainage basins: river basins, spring areas, main rivers and courses, accumulation and accumulation areas, canals;
- Infrastructure: urban areas, roads;
- Forestry: existing forests (as per form, type, mixture and function);
- Socio-economic information: popular trends;
- Administrative areas: municipalities, cadastral municipalities, forest-agricultural areas, management units.

Principles of afforestation area selection

In the framework of the Action Plan, municipalities, in which it is necessary to perform afforestation, are selected: Novi Pazar, Sjenica, Tutin, Raška, Vranje, Bujanovac, Preševo, Trgovište, Bosilegrad, Surdulica, Vladicin Han and Belgrade.

Table 1. Potential afforestation areas as per dynamics.

Municipality	Year										Total (ha)
	2015	2016	2017	2018	2019	2020	2021	2022	2023	2024	
Novi Pazar	100	100	200	200	200	200	200	200	200	200	1.800
Sjenica	500	700	700	800	800	1.000	1.000	1.000	1.000	1.000	8.500
Tutin	100	100	200	200	200	200	200	200	200	200	1.800
Raška	100	100	200	200	200	200	200	200	200	200	1.800
Vranje	50	50	50	50	50	50	50	50	50	50	500
Bujanovac	50	50	100	100	150	150	150	150	150	150	1.200
Preševo	50	50	50	50	50	50	50	50	50	50	500
Trgovište	100	100	100	100	100	150	150	150	150	150	1.250
Bosilegrad	200	200	200	250	250	300	300	300	300	300	2.600
Surdulica	300	300	300	350	350	400	400	400	400	400	3.600
Vladicin Han	20	30	30	30	50	50	50	50	50	50	410
Belgrade	200	300	400	400	500	500	500	500	500	500	4.300
TOTAL	1.770	2.080	2.530	2.730	2.900	3.250	3.250	3.250	3.250	3.250	28.620

For the purpose of selection of areas suitable for afforestation, detailed terrain recognition was performed. A particular attention was paid to non-productive pastures, lower fertility soils, as well as the areas affected by erosion (V, VI and VII class fertility soils). Non-productive stone fields have not been considered, as their revitalisation would require incurring large costs with entirely uncertain outcome (Ratknić and Šmit 1999). For the purpose of preservation of biodiversity of natural habitats, not all soils of the above-

mentioned categories were included, but some were abandoned to natural succession of vegetation. In the period 2015-2024, the Strategy envisages the afforestation of 28,620 ha (Table 1).

Financing of action plan implementation

Providing afforestation funding stipulated by the Strategy is related to reforms of environmental policy, particularly to establishing effective and de-centralised system of financing and modernisation of environmental infrastructure, as well as monitoring system.

The basic principle of afforestation financing is full application of the principle 'the polluter pays'. Polluters are obligated to participate in realisation of afforestation projects, not only those in their immediate vicinity (by plantation of protection forests), but in the broader area. Generally, the full amount of costs should be covered from the payments made by the service-users. Several financing instruments have been used for project financing, including:

- own funds (republic, city, municipality budgets; generated profit or savings);
- grants or international donations (European Bank for Reconstruction, World Bank, funds from bilateral treaties);
- credits provided by international financial institutions (European Bank for Reconstruction, World Bank);
- subsidies provided by Environmental Protection Fund;
- income generated through fees for services.

The Strategy envisages that the main sources of afforestation financing are: the polluters (consumers and industry), municipalities and public enterprises, budget of the Republic of Serbia and municipalities, and international donors.

International grants represent the most important available source of afforestation financing (it is assumed that it will cover approximately 24% of costs). About 14% will be provided from the budget of the Republic of Serbia, while the other available sources (consumer electricity-bill payments, the Environment Protection Fund) will provide between 5% and 7%. It is estimated that about 44% of the afforestation costs will be covered by the City of Belgrade with the municipalities (or public enterprises) and the industry. The funds that are lacking for realisation of afforestation (about 11-13%) can be obtained through commercial credits (for establishment of intensive plantations) and other sources.

Afforestation action plan implementation

A first step in Afforestation Strategy implementation is its institutionalisation, by means of its adoption by relevant institutions. Special units will be formed, responsible for implementation of activities related to afforestation, co-ordination and communication with interested parties, as well as Strategy implementation, monitoring implementation progress, updating documentation and providing information. An active approach is expected particularly from the relevant ministries, Environmental Protection Secretariat,

industry and municipalities.

For a successful afforestation management in the implementation phase, an active distribution of information regarding the development of activities will be necessary (the Internet, press conferences, report distribution, media reporting, etc.)

The implementation plan contains description of each activity and its role within the Strategy, persons and institutions responsible for implementation, expected results, realisation indicators, and a list of tasks necessary for realisation of activities, necessary inputs, cost estimates and authorisations.

Monitoring of action plan implementation

Implementation of the Strategy requires monitoring, which is based on defined and measurable criteria. The criteria for monitoring of the Strategy implementation include the following: timely realisation of activities (measurable indicator 85%); utilisation of funds provided; a number of reports on realisation monitoring (not less than one report per year); a number of meetings held (not less than one per year); reduced emission of air pollutants; reduced pollution, reduced noise emission; increased energy and raw-material efficiency; provision of information on Strategy implementation; development of public awareness, measured by means of surveys.

CONCLUSION

In addition to providing principles for afforestation area selection and facilitating habitat and biodiversity preservation, the expert system developed within the Strategy enables timely preparations for afforestation and transition to operational work organisation – production of seedlings of known provenances for habitats of known characteristics, with selection of optimum method of seedling material production and afforestation technology.

REFERENCES

- Parker W.C., Colombo S.J., Cherry M.L., Flannigan M.D., Greifenhagen S., McAlpine R.S., Papadopol C.S., Scarr T. (2000). Third millennium forestry: what climate change might mean to forests and forest management in Ontario. *Forestry Chronicle* 76, pp. 445–463.
- Ratknić M., Šmit S. (1999). Demarcation of agricultural and forest land and optimum use of areas in forestry - the example of the Pešter plateau, Monograph, JP Srbijašume-Institute of Forestry, Belgrade, pp 1-124.
- Ratknic M. (2004). Technique and technology of afforestation of extremely unfavourable stands in hilly-mountain regions of Serbia, Project Report No 401-00-295/4/03-06 financed by the Ministry of Agriculture, Forestry and Water Management-Forest Administration, Institute of Forestry, Belgrade.
- Ratknic M. (2005). Conservation, improvement and sustainable use of wild forest fruit trees genofund in the region of Serbia, Project Report No 401-00-1243/1/2004-10 financed by the Ministry of Agriculture, Forestry and Water Management-Forest Administration (2004-2005), Institute of Forestry, Belgrade.

PROCEEDINGS
International Conference **REFORESTATION CHALLENGES**
03-06 June 2015, Belgrade, Serbia

- Ratknić M. (2008). Study of contemporary afforestation methods under climatically changed conditions (drought, extremely high temperatures, etc), Project Report No 401-00-3571/1/2008-10 financed by the Ministry of Agriculture, Forestry and Water Management-Forest Administration, Institute of Forestry, Belgrade.
- Ratknić M., Veselinović M., Rakonjac Lj. (2009). Belgrade region afforestation strategy. Monograph. Institute of Forestry, Belgrade, pp. 1-277.
- Ratknić M., Rakonjac Lj., Veselinovic M. (2010). The climate change and forest ecosystems, International Scientific Conference „Forest ecosystems and climate changes“ – Plenary lectures, March 9-10th, Institute of forestry, Belgrade, Serbia, pp 91-115.
- Serbian Afforestation Strategy 2014-2018. Project financed by the Ministry of Agriculture, Forestry and Water Management – Forest Administration (2013), Institute of forestry
- Tyree M.T. (2003). Hydraulic limits on tree performance: transpiration, carbon gain, and growth of trees. *Trees* 17, pp. 95–100.
- Wang Z.M., Lechowicz M.J., Potvin C. (1995). Responses of black spruce seedlings to simulated present versus future seedbed environments. *Canadian Journal of Forest Research* 25, pp. 545–554.

BELGRADE AFFORESTATION STRATEGY

Ratknić Mihailo, Rakonjac Ljubinko, Braunović Sonja, Ćirković-Mitrović Tatjana, Stajić Snežana, Ratknić Tatjana

Ratknić M., Rakonjac Lj., Braunović S., Ćirković-Mitrović T., Stajić S., Ratknić T. (2015). Belgrade afforestation strategy. In: Ivetić V., Stanković D. (eds.) Proceedings: International conference Reforestation Challenges. 03-06 June 2015, Belgrade, Serbia. Reforesta. pp. 23-32.

Abstract: Aiming at the increase of a current afforestation level (12%), the Belgrade City Assembly adopted the Belgrade Area Afforestation Strategy (City of Belgrade 'Official Gazette' number 20, 14 June 2011). The Strategy envisages plantation of 50,000 ha of new forests in the following ten years. The Strategy should attain the following objectives: protection of natural processes and identity of an area; an area structure that is in conformity with habitat, permanent retaining of a habitat's function and reduction of harmful impact by preserving and improving natural and artificial coverage in urban centres; preservation and improvement of natural and artificial vegetation coverage (wood shelter-belts, hedges, reserves, etc) in agricultural zones in the vicinity of urban centres, of significant importance for city ecosystem; development of potential vegetation on soils where vegetation coverage is removed, while the soil is not used for agriculture or forestry; soil erosion control, protection of biodiversity's species and ecosystem components; protection and improvement of existing natural habitats in built-up areas: forests, hedges, tree lines, forest fringe biotopes, streams, fish ponds and other ecologically important small structures etc. Being mandatory, the Strategy is integrated in all higher- level spatial plans.

Key words: afforestation strategy, spatial plan, Belgrade, Serbia.

INTRODUCTION

The adverse afforestation condition in the Belgrade area has called for creation of plans for extensive works on afforestation of barren land, anthropogenically destroyed forest complexes and agricultural areas suffering from erosion, along with plans for protection of forests and rehabilitation of degraded terrains, waste and tailing disposal sites. The Belgrade City Administration – Environment Protection Secretariat and the Institute of Forestry, Belgrade, embarked on preparation of the 'Belgrade Area Afforestation Strategy,' in March 2008. The Strategy was unanimously adopted at the session of the City Assembly and published in the City of Belgrade 'Official Gazette' on 14 June 2011. The Strategy was harmonised with international and ratified multilateral treaties and conventions, European strategic documents, City's local legislation and regulations and planning documents.

SUBJECT MATTER AND OBJECTIVES OF AFFORESTATION STRATEGY

The Belgrade Area Afforestation Strategy stipulates the activities aimed at rational use of forest resources, biodiversity protection and enhancement of environment quality. The Strategy's subject matter is the improvement of condition of natural forests and artificially-established stands of autochthonous and allochthonous broadleaf and coniferous species, plantation of new forests and green areas of all categories and their connecting into a functional unity.

The objective of the Belgrade Area Afforestation Strategy is the provision of professional and scientific basis for establishment of new plantations, thus contributing to the improvement of environmental condition and developing other activities related to planned use of forest resources.

At the same time, the Strategy represents the documentation basis that can be integrated into higher level spatial and strategic plans. The Strategy's priority objectives are the following:

- protection of intra-city green areas and suburban forests within their existing boundaries; protection of foreland forests and river islands; protection of remaining marshes, ponds and wet areas;
- connecting the existing forests into a green belt encompassing city and suburban municipalities and establishing a link between the green belt and intra-city area;
- creation of a networked system of green areas, by means of using linear connections between the existing and the planned green areas;
- connecting the city greenery system with regional forests;
- identifying new nature protection areas;
- afforestation aimed at providing wind protection, protection against harmful emissions and integral nature protection in areas with intensive agricultural activities;
- a high percentage afforestation in water-source protection areas;
- revitalisation of small city water courses, enabling their multi-functional use (retentions, green links with suburban recreational areas, etc);
- rehabilitation of the broader Sava and Danube area, which involves removal of inappropriate facilities and contents; formation of continuous line greenery in river areas, where possible;
- creation of small green areas and line greenery in the intra-city area through urban renewal;
- conversion of unregulated areas, not intended for construction activities, into public green areas;
- construction of biological treatment systems for waters supplying ponds and marshes;
- removal of false indigo (*Amorpha fruticosa*), aimed at protecting ponds and marshes;
- gradual conversion of poplar plantations into natural vegetation species.

BELGRADE AREA ECOLOGICAL CHARACTERISTICS

Climate characteristics. The Belgrade area climate characteristics were analysed based on a long-standing average of the basic climate parameters: the mean monthly temperature with annual averages, the absolute maximum and minimum temperature with the number of below-zero and hot days, the mean monthly, season and annual precipitation, relative humidity and insolation. Climate parameters of importance for both vegetation and erosion processes occurring in the Belgrade area are presented. Local modification of the Belgrade area climate parameters and climate changes typical of this area were also analysed.

Hydrographical properties of the terrain. The main water courses that drain the terrain of the Belgrade area – the River Sava and the River Danube, along with other small water courses, left and right tributaries to the River Sava and the River Danube, which jointly create an unevenly developed hydrographical network, were analysed.

Terrain classification. Geological-geomorphological and hydrogeological characteristics are classified into five categories. Hydrogeological terrain properties affect soil quality of agricultural land and forests; consequently, the terrain is divided into different hydrogeological zones according to the level of water permeability and dewatering rate, that is, the conditions for formation of ground waters (18 zones). For the purpose of attaining the Strategy's objectives, terrain characterisation and identification of different terrain types within the broader Belgrade area were conducted, in compliance with the contemporary trends in this field (includes 11 types, with their development dynamics).

Belgrade soils. Soil types, whose formation is a result of a complex of Belgrade area pedogenetic factors, feature hydromorphical, terrestrial and anthropogenic soils. A spatial distribution chart of represented soil types was created, which is, along with other parameters, of decisive importance for the selection of the type and technology of afforestation.

Belgrade area habitats. The Serbian habitat classification system is based on the EUNIS classification system. This classification was created with a view to providing a universal and integrated classification of European habitats. The Belgrade area habitats are also classified on the basis of this system (Table 1).

Soil erosion. 98.9% of mainly agricultural and forest land in the Belgrade area is affected by soil erosion processes of various intensity. The affected areas are presented as far as the cadastral municipality level. For each cadastral municipality, a percentage share of the affected area, as per the erosion category (scale 1-5) was determined, along with the erosion coefficient value and cadastral municipality erosion category. All major landslide-prone slopes in the Belgrade area are presented.

SELECTION OF AFFORESTATION SPECIES

In the process of selection of afforestation species, the following rules were observed:

PROCEEDINGS
International Conference **REFORESTATION CHALLENGES**
03-06 June 2015, Belgrade, Serbia

- To use solely autochthonous tree and shrub species in the process of afforestation and plantation of non-forest greenery. Allochthonous broadleaf species and autochthonous and allochthonous coniferous species can be used only for plantation of public greenery and in the protection areas around industrial facilities.
- To prevent spreading and / or take measures for destruction of invasive tree and shrub species, which disturb natural forest and other ecosystems (*Acer negundo*, *Ailanthus glandulosa*, *Amorpha fruticosa*, *Celtis occidentalis*, *Robinia pseudoacacia*, and others).
- To prevent use of allergenic species in the process of establishing greenery in urban areas.
- To prevent use of cultivars and clones in natural or partially-modified natural habitats.

In the process of selection of afforestation tree species, a broad range of species was provided for each habitat. 'Principal, accessory and shrub tree species' were defined - edicators of prospective communities on a given area.

Table 1: Overview of principal, accessory and shrub species as per habitats.

Habitat	Principal, accessory and shrub species
Continental willow (<i>Salix</i>) galleries on receding alluvial deposits (G1.1141)	Principal species: <i>Salix alba</i> Accessory species: <i>Populus nigra</i> , <i>Fraxinus viridis</i> , <i>Ulmus effusa</i> , <i>Ulmus carpiniifolia</i> Shrubs: <i>Cornus sanguinea</i> , <i>Salix amygdalina</i> , <i>Salix fragilis</i> , <i>Salix purpurea</i>
Continental willow (<i>Salix</i>) galleries on gley soils (G1.1142)	Principal species: <i>Salix alba</i> Accessory species: <i>Fraxinus angustifolia</i> , <i>Populus nigra</i> , <i>Fraxinus viridis</i> , Shrubs: <i>Salix amygdalina</i> , <i>Salix cinerea</i> , <i>Rhamnus frangula</i>
Floodplain willow and poplar forests (G1.115)	Principal species: <i>Salix alba</i> , <i>Populus nigra</i> Accessory species - <i>Fraxinus angustifolia</i> , <i>Populus alba</i> , Shrubs - <i>Cornus sanguinea</i> , <i>Crataegus nigra</i> , <i>Salix amygdalina</i> , <i>Salix fragilis</i> , <i>Salix purpurea</i> , <i>Prunus spinosa</i> , <i>Sambucus ebulus</i> , <i>Vitis sylvestris</i>
Floodplain white poplar forests (<i>Populus alba</i>) (G1.116)	Principal species: <i>Populus alba</i> , <i>Quercus robur</i> Accessory species: <i>Fraxinus angustifolia</i> , <i>Ulmus campestris</i> , <i>Ulmus minor</i> Shrubs: <i>Cornus sanguinea</i> , <i>Sambucus nigra</i> , <i>Viburnum opulus</i>
Floodplain black poplar forests (<i>Populus nigra</i>) (G1.117)	Principal species: <i>Populus nigra</i> Accessory species: <i>Populus alba</i> , <i>Fraxinus angustifolia</i> , <i>Ulmus effusa</i> , <i>Quercus robur</i> Shrubs: <i>Salix cinerea</i> , <i>Viburnum opulus</i> , <i>Cornus sanguinea</i> , <i>Crataegus nigra</i>
Mixed floodplain black poplar (<i>Populus nigra</i>) and white poplar (<i>Populus alba</i>) forests (G1.119)	Principal species: <i>Populus nigra</i> , <i>Populus alba</i> Accessory species: <i>Fraxinus angustifolia</i> , <i>Ulmus effusa</i> Shrubs: <i>Salix purpurea</i> , <i>Viburnum opulus</i> , <i>Rhamnus frangula</i> , <i>Cornus sanguinea</i>

PROCEEDINGS
International Conference **REFORESTATION CHALLENGES**
03-06 June 2015, Belgrade, Serbia

Table 1: Cont.

Habitat	Principal, accessory and shrub species
Mixed narrow-leaved ash (<i>Fraxinus angustifolia</i>) and pedunculate oak (<i>Quercus robur</i>) forests along large rivers (G1.2231)	Principal species: <i>Quercus robur</i> , <i>Fraxinus angustifolia</i> Accessory species: <i>Ulmus effusa</i> , <i>Fraxinus excelsior</i> , <i>Acer campestre</i> , <i>Acer tataricum</i> Shrubs: <i>Cornus sanguinea</i> , <i>Crataegus monogyna</i> , <i>Crataegus oxyacantha</i> , <i>Evonymus europaeus</i> , <i>Rhamnus frangula</i>
Mixed narrow-leaf ash (<i>Fraxinus angustifolia</i>), pedunculate oak (<i>Quercus robur</i>) and hornbeam (<i>Carpinus betulus</i>) forests along large rivers (G1.2233)	Principal species: <i>Quercus robur</i> , <i>Fraxinus angustifolia</i> Accessory species: <i>Carpinus betulus</i> , <i>Fraxinus excelsior</i> , <i>Acer campestre</i> , <i>Acer tataricum</i> , <i>Pyrus pyraeaster</i> , <i>Prunus avium</i> , Shrubs: <i>Cornus sanguinea</i> , <i>Crataegus monogyna</i> , <i>Crataegus oxyacantha</i> , <i>Evonymus europaeus</i> , <i>Rhamnus frangula</i>
Hygrophilous pedunculate oak (<i>Quercus robur</i>) and hornbeam (<i>Carpinus betulus</i>) forests (G1.2234)	Principal species: <i>Quercus robur</i> , <i>Carpinus betulus</i> Accessory species: <i>Fraxinus angustifolia</i> , <i>Prunus avium</i> , <i>Tilia cordata</i> , <i>Tilia tomentosa</i> , <i>Ulmus carpinifolia</i> , <i>Ulmus minor</i> , <i>Acer campestre</i> Shrubs: <i>Cornus mas</i> , <i>Cornus sanguinea</i> , <i>Crataegus monogyna</i> , <i>Crataegus oxyacantha</i> , <i>Evonymus europaeus</i> , <i>Corylus avellana</i> , <i>Prunus spinosa</i>
Fen oak (<i>Quercus</i>) forests (G1.42)	Principal species: <i>Quercus robur</i> , Accessory species: <i>Fraxinus angustifolia</i> , <i>Acer campestre</i> , <i>Prunus avium</i> , <i>Ulmus carpinifolia</i> , Shrubs: <i>Cornus sanguinea</i> , <i>Crataegus monogyna</i> , <i>Crataegus oxyacantha</i> , <i>Evonymus europaeus</i> , <i>Prunus spinosa</i>
Fen narrow-leaf ash (<i>Fraxinus angustifolia</i>) forests (G1.44)	Principal species: <i>Fraxinus angustifolia</i> Accessory species: <i>Quercus robur</i> , <i>Ulmus effusa</i> , <i>Prunus avium</i> , <i>Ulmus carpinifolia</i> , Shrubs: <i>Cornus sanguinea</i> , <i>Viburnum opulus</i>
Mesic mono-dominant hilly beech forests (G1.6911)	Principal species: <i>Fagus moesiaca</i> Accessory species: <i>Acer campestre</i> , <i>Carpinus betulus</i> , <i>Quercus cerris</i> , <i>Quercus petraea</i> , <i>Sorbus torminalis</i> , <i>Tilia platyphyllos</i> , <i>Tilia tomentosa</i> Shrubs: <i>Corylus avelana</i> , <i>Cornus mas</i> , <i>Crataegus monogyna</i>
Mesic hilly beech forests with lime trees (<i>Tilia</i> spp. (G1.6913)	Principal species: <i>Fagus moesiaca</i> Accessory species: <i>Acer campestre</i> , <i>Carpinus betulus</i> , <i>Quercus cerris</i> , <i>Quercus petraea</i> , <i>Sorbus torminalis</i> , <i>Tilia platyphyllos</i> , <i>Tilia tomentosa</i> , <i>Prunus avium</i> Shrubs: <i>Corylus avelana</i> , <i>Cornus mas</i> , <i>Crataegus monogyna</i> , <i>Evonymus europaeus</i>
Typical Hungarian oak and Turkey oak forest (G1.7611)	Principal species: <i>Quercus frainetto</i> , <i>Quercus cerris</i> Accessory species: <i>Acer campestre</i> , <i>Pyrus communis</i> , <i>Prunus avium</i> , Shrubs: <i>Cornus sanguinea</i> , <i>Cornus mas</i> , <i>Crataegus monogyna</i> , <i>Prunus spinosa</i> , <i>Viburnum lantana</i>

PROCEEDINGS
International Conference **REFORESTATION CHALLENGES**
03-06 June 2015, Belgrade, Serbia

Table 1: Cont.

Habitat	Principal, accessory and shrub species
Hungarian oak and Turkey oak forest with butcher's broom (<i>Ruscus aculeatus</i>) (G1.7612)	Principal species: <i>Quercus frainetto</i> , <i>Quercus cerris</i> Accessory species: <i>Acer campestre</i> , <i>Pyrus communis</i> , <i>Prunus avium</i> , <i>Sorbus domestica</i> , <i>Sorbus torminalis</i> , <i>Pirus malus</i> , <i>Pirus piraster</i> Shrubs: <i>Cornus sanguinea</i> , <i>Crataegus monogina</i> , <i>Crataegus oxyacantha</i> , <i>Prunus spinosa</i> , <i>Viburnum lantana</i>
Hungarian oak and Turkey oak forest with hornbeam (<i>Carpinus betulus</i>) (G. 1.7615)	Principal species: <i>Quercus frainetto</i> , <i>Quercus cerris</i> Accessory species: <i>Carpinus betulus</i> , <i>Pyrus communis</i> , <i>Prunus avium</i> , <i>Pirus piraster</i> Shrubs: <i>Cornus sanguinea</i> , <i>Cornus mas</i> , <i>Crataegus monogina</i> , <i>Euonymus verrucosus</i> , <i>Prunus spinosa</i> , <i>Viburnum lantana</i>
Mesic Vergilian oak (<i>Quercus virgiliana</i>) forests (G1.763)	Principal species: <i>Quercus virgiliana</i> Accessory species: <i>Quercus pubescens</i> , <i>Pirus piraster</i> , <i>Carpinus orientalis</i> Shrubs: <i>Crataegus monogina</i> , <i>Crataegus pentagyna</i> , <i>Evonimus verrucosus</i> , <i>Prunus spinosa</i> , <i>Ligustrum vulgare</i>
Pannonian Vergilian oak (<i>Quercus virgiliana</i>) forests (G1.7A12)	Principal species: <i>Quercus virgiliana</i> , <i>Tilia tomentosa</i> Accessory species: <i>Quercus cerris</i> , <i>Ulmus minor</i> , <i>Acer campestre</i> Shrubs: <i>Crataegus monogina</i> , <i>Crataegus pentagyna</i> , <i>Prunus spinosa</i> , <i>Rosa canina</i>
Pannonian pedunculate oak (<i>Quercus robur</i>) forests on loess (G1.7A14)	Principal species: <i>Quercus robur</i> Accessory species: <i>Tilia tomentosa</i> , <i>Quercus farnetto</i> , <i>Ulmus campestris</i> , <i>Malus silvestris</i> Shrubs: <i>Cornus mas</i> , <i>Cornus sanguinea</i> , <i>Corylus avellana</i> , <i>Crataegus monogyna</i> , <i>Prunus mahaleb</i> , <i>Prunus spinosa</i>
Pannonian sessile oak (<i>Quercus petraea</i>) and Turkey oak (<i>Quercus cerris</i>) forests (G1.7A15)	Principal species: <i>Quercus petraea</i> , <i>Quercus cerris</i> Accessory species: <i>Acer platanoides</i> , <i>Quercus pubescens</i> , <i>Acer tataricum</i> , <i>Pyrus communis</i> , <i>Sorbus aucuparia</i> Shrubs: <i>Crataegus monogyna</i> , <i>Corylus avelana</i> , <i>Cornus sanguinea</i>
Mesic acidophilus sessile oak (<i>Quercus petraea</i>) forests (G1.871)	Principal species: <i>Quercus petraea</i> , Accessory species: <i>Betula alba</i> , <i>Tilia argentea</i> , <i>Quercus cerris</i> , <i>Pyrus pyraster</i> , Shrubs: <i>Cornus mas</i> , <i>Corylus avelana</i> , <i>Rosa arvensis</i>

PLANNED AFFORESTATION AND PLANTATION OF PUBLIC GREENERY

The afforestation strategy envisages an increase of the total afforested area, primarily at the expense of building land in the suburbs, with a view to preserving the quality agricultural land and forests and creating conditions for development of recreational areas, particularly on the territory of peripheral municipalities (Barajevo, Mladenovac, and Sopot).

Creation of a protection green belt around the city area and its connecting, by

PROCEEDINGS
International Conference **REFORESTATION CHALLENGES**
03-06 June 2015, Belgrade, Serbia

means of green corridors, with the inner-city greenery will contribute to more effective protection of the city's nucleus environment. In the inner-city municipalities, creation of new parks, squares, small green areas, line greenery, along with the makeover of inner courtyards within closed building blocks, have been planned.

In peri-urban municipalities, new afforestation has been planned on eroded, steep, infertile and unstable terrains and landslide-prone slopes, in the areas of importance for establishment of wind shelter-belts and in the direction into which illegal building is spreading.

Creation of network of field, road and industrial zone shelter-belts has been planned in the plains in the north of the city. Plantation of line greenery and line corridors has been planned along the banks of the River Sava and Danube and the 'crown' of Zemun loess plateau, where possible.

In the water-source protection zones, plantation of new forests has been planned. Along the valleys of small city water courses, creation of multi-purpose 'green oasis' has been planned.

Full development of the greenery system imposes the need for removal of temporary facilities and illegal waste disposal sites from all-category green areas, along with revitalisation and application of tending measures in the existing green areas.

The increase of green areas has been planned at the Voždovac, Banovo Brdo and Novi Beograd city quarters, on the housing plots and other-purpose plots, as well as for connecting individual greenery elements.

Table 2. The total area intended for afforestation in the Belgrade city area.

Soil quality grade		Road protection									
		I zone	II zone	railway	Water springs	Water spring protection	Unstable terrain protection	Landslide protection	Erosion protection	Wind shelter belts	Tailing and ash disposal sites
VI	VII										
3018.40	313.54	1448.03	3594.94	320.58	4721.86	6871.79	15580.18	2763.28	55799.07	1646.81	1833.00

Plantation of greenery along the Danube river bank, from the Bulevar Umetnosti Street to Karađorđev Trg, which is a fixed part of the greenery system, and includes a proposal for area protection, is of particular importance. For the purpose of attaining continuity of this bank's greenery, which should extend all the way to Ušće (the confluence), creation of a green belt has been planned along the Zemun loess plateau – along the 'crown' and the slopes (which is a part of the green belt in the city greenery system, that spreads along the Danube banks at Batajnica and ends at the Bežanijska Kosa slopes).

The largest scope of afforestation has been planned to be performed on the territory of suburban municipalities, at the expense of land originally intended for different type of use. Afforestation has been planned on the agricultural areas of VI and VII soil quality grade. For the purpose of attaining optimum use of space, it is necessary to perform demarcation between the agricultural and forest land (based on the ecological, economic and social characteristics). On the agricultural land of low soil quality, which will

still be used for agricultural production, agricultural-forest systems will be introduced, aimed at improving plant and livestock production.

The Belgrade Area Afforestation Strategy envisages plantation of cultures and green areas on 99,918.53 ha.

ECONOMIC AND FINANCIAL VALUE OF THE EXISTING AND NEWLY-ESTABLISHED FORESTS AND FOREST ECOSYSTEMS

In addition to financial benefits, valuation and assessment of socially-beneficial forest functions encompasses the total effects of forest functions. A large number of the below-mentioned functions cannot be realised on the market immediately; therefore, a coefficient method is applied, related to the value of mature stands' wood mass and stating the respective generally-beneficial forest functions. The applied coefficients are the following: for wood value 1.00; for secondary forest products 0.44; for hydrological forest function 0.33; for climate functions 1.85; for sanitary-health function 0.49; for recreational role 0.41 and for protection role 0.35 (Ratknić et al, 2010). By accomplishing afforestation of 50,000 ha, the value of newly-established forests would amount to EUR 2,454,517,100, while the maximum value would be EUR 4,909,034,200. By accomplishing afforestation of the planned 99,918.53ha, the minimum value would amount to EUR 4,925,823,098, while the maximum value would be EUR 9,842,290,308 EUR.

The role of forests and forest ecosystems in carbon accumulation. The planned afforestation of between 50,000 and 100,000 ha has the capacity for binding between 9,870,000 and 19,740,000 tons of carbon. Translated into the price of ton of carbon-dioxide equivalent on the international market, the value of carbon accumulation would range between EUR 198,000,000 and EUR 396,000,000.

Importance of greenery for energy savings. The analyses of energy savings in certain world capitals indicate that the planned plantation of greenery around housing blocks and family houses can contribute to heating savings from 4% to 22%, and to cooling savings from 10% to even 50%. The total energy savings can reach 30% at the annual level (NAA/ISA, 1991). Given the average annual power consumption in the Belgrade area (7,533 kWh per household, the data from the Republic Statistical Office) and the estimated price per kWh (5.5 euro-cents per kW, Electric Power Serbia), the total power savings, applied only in 10% of the households, can reach EUR 7,100,000 annually.

AFFORESTATION STRATEGY FINANCING AND MONITORING

The basic principle of afforestation financing is application of the principle 'the polluter pays'. Polluters are obligated to participate in realisation of afforestation projects, not only those in their immediate vicinity (by plantation of protection forests), but in the broader city area. Generally, the full amount of costs should be covered from the payments made by the service-users. The Strategy envisages that the main sources of afforestation financing are the polluters (consumers and industry), municipalities and public enterprises, the budget of Republic of Serbia, the budget of the City of Belgrade and international donors. International grants represent the most important available source

of afforestation financing (it is assumed that they will cover about 24% of the costs). About 14% will be provided from the budget of the Republic of Serbia, while the other available sources (consumer electricity bill payments, the Environment Protection Fund) will provide between 5% and 7%. It is estimated that about 44% of the afforestation costs will be covered by the City of Belgrade and municipalities (or public enterprises) and the industry. The funds that are lacking for realisation of afforestation (about 11-13%) can be obtained through commercial credits (for establishment of intensive plantations) and other sources.

Implementation of the Strategy requires monitoring, which is based on defined and measurable criteria. The criteria for monitoring of the Strategy implementation include the following: timely realisation of activities (measurable indicator 85%); utilisation of funds provided; a number of reports on realisation monitoring (not less than one report per year); a number of meetings held (not less than one per year); reduced emission of air pollutants; reduced pollution, reduced noise emission; increased energy and raw-material efficiency; provision of information on Strategy implementation; development of public awareness, measured by means of surveys.

CONCLUSIONS

The key priority of the future city development is achieving rational organisation, use and development of space, conformed with preservation of the existing natural values and environment protection. In that respect, development and improvement of forestry through an increase of quality of the existing and creation of new urban forests and other green areas, given their previous low representation, occupy a particularly important place. Creation of connection between the existing forest complexes and new forests, wind shelter-belts and green corridors on available land, will ensure a good connection between the city greenery and forest complexes and facilitate exertion of indirect impact of forest generally-beneficial functions on city's nucleus.

The Belgrade Area Afforestation Strategy envisages plantation of cultures and green areas on 99,918.53 hectares.

REFERENCES

- Generalni plan Mladenovca (2021). „Službeni list grada Beograda“, broj 9/2005.
- Generalni urbanistički plan Beograda (2003). „Službeni list grada Beograda“, godina XLVII, broj 27.
- Đorđević S. (2007). Climate change and variability of extreme climate events in Belgrade, Republic Hydrometeorological Service of Serbia, Belgrade, Serbia, web strana: www.cosis.net/abstracts/EMS2007/00316/EMS2007-J-00316.pdf
- Živadinović V., Isajev, D. (2006). Problemi gazdovanja šumama na području Beograda, Šumarstvo br.3. UŠITS, Beograd.
- Zakon o zaštiti životne sredine (1991) („Službeni glasnik Republike Srbije“, broj 135/04).
- Jovanović B. (1971): Neke nove alohtone vrste u dendroflori Beograda i okoline. Glasnik Šumarskog fakulteta, Beograd.
- Jovanović B., Vukićević E. (1977). Potencijalna vegetacija park šume Titov gaj (sa kartom). Glasnik Šumarskog fakulteta br. 52. Beograd. p. 15-53.

- Kvalitet životne sredine grada Beograda u 2007. godini. (2008). Sekretarijat za zaštitu životne sredine, Beograd.
- Medarević M. (1991). Vrednovanje prirodnih pogodnosti šuma za rekreaciju u okolini Beograda, Magistarski rad, Šumarski fakultet u Beogradu.
- Medarević M. (2006). Plan uvećanja šumovitosti Srbije-osnovni uslovi za realizaciju. Savetovanje "Pošumljavanje u cilju realizacije prostornog plana i razvoja poljoprivrede, šumarstva i vodoprivrede Republike Srbije", Zbornik radova, Novi Sad str.3-17.
- Milanović H. (2008). Zaštićena prirodna dobra Beograda, zapis 2008. Grad Beograd-Gradska uprava, Sekretarijat za zaštitu životne sredine, Zavod za zaštitu prirode Srbije, Beograd.
- Nikolić B., Veselinović M., Batos B., Cvejić M. (2005). Ugrožena i značajna flora u šumama na području Beograda. Zbornik Instituta za šumarstvo. Tom 52-53, pp. 103-114. Beograd.
- Opšta osnova gazdovanja šumama za "Posavsko-podunavsko" šumsko područje (2001-2010). Plan generalne regulacije dela gradskog naselja Lazarevac. Službeni list grada Beograda 6/08.
- Posebna osnova za gazdovanje šumama za GJ "Reik-Kolubara".
- Projekat „Zelena regulativa Beograda“ (2004), www.urbel.com/documents/zelena_regulativa_beograd.pdf
- Prostorni plan Beograda, (2002):
http://www.beograd.rs/documents/regplan/prostorni_plan_beograda.pdf
- Ratknić M. (ed.): Razvoj kapaciteta privatnog sektora za održivo gazdovanje šumama u Srbiji (Budovanie kapacít súkromného sektora petrvalo udržateľne obhospodarovanie lesov v Srpskej Republike), Institut za šumarstvo, Beograd, 2008.
- Smernice za gazdovanje plantažama (intenzivnim zasadima) klonskih sorti topola i vrba (2007). Vojvodinašume.
- Strategija razvoja grada Beograda (2008), nacrt, Palgo center, Beograd,
http://www.beograd.org.yu/download.php/documents//nacrt_strategije_razvoja.pdf
- Crvena knjiga flore Srbije, Tom 1, 1999, pp. 100 i 128.

MARKET POTENTIAL DYNAMICS FOR PLANTATION-GROWN POPLAR FOREST PRODUCTS IN SERBIA

Keča Ljiljana*, Keča Nenad

*Corresponding author: ljiljana.keca@sfb.bg.ac.rs

Keča Lj., Keča N. (2015). Market potential dynamics for plantation-grown poplar forest products in Serbia. In: Ivetić V., Stanković D. (eds.) Proceedings: International conference Reforestation Challenges. 03-06 June 2015, Belgrade, Serbia. Reforesta. pp. 33-41.

Abstract: Forest plantations are becoming more prevalent globally to meet the increasing demand for wood and fiber from a reduced land base. Intensive management of plantation forests can help meet this demand for forest products and still reserve large areas of forests for conservation, preservation, recreation, and other uses.

Serbia's forest reserves which cover approximately 27% of the country's land area or about two million hectares are estimated to be containing 235 million m³ of standing inventory. Forest reserves are found mainly in the plains in the autonomous province of Vojvodina and the mountain regions in Central Serbia dominated by poplar, oak, and beech.

Poplar, especially euro-american hybrids, is one of the most productive fast growing tree species in Serbia. As such, poplar plantations are increasing in importance in Serbia.

The objective of this article is to profile the plantation poplar industry in Serbia through the supply chain from the forest to manufacturing and to end-use markets. Each step in the supply chain will be examined to identify current and potential poplar wood products, origin and quality of logs, mill processing capabilities, and market drivers. In addition, supply chain dynamics will be examined for the 2008-2012 period.

By examining the recent past and the present, this study offers a perspective on improving market development for plantation poplar in Serbia.

Key words: market, poplar, Serbia, supply chain.

INTRODUCTION

Serbia owns the great production potential of hybrid poplars, especially clone I-214 (Keča et al. 2012) on some of the best sites for poplar establishment in Europe (Herpka et al. 1986). The total area of poplar plantations in Serbia is about 48,000 ha (2.1% of the forest areas in Serbia) (Banković et al. 2009). About 36,000 ha of poplar plantations are situated in Vojvodina (Table 1).

PROCEEDINGS
International Conference **REFORESTATION CHALLENGES**
03-06 June 2015, Belgrade, Serbia

Table 1. Main data on poplars in Serbia and the province of Vojvodina

Legend	Value	Unit	Additional
Area of poplars in Serbia	48,000	<i>ha</i>	
Ownership	state	83.3	%
Plantations	74.2		%
Semi-natural stands	25.8		%
Plantation density	289	trees·ha ⁻¹	
Average volume	175	m ³ ·ha ⁻¹	6,137,862 m ³
Volume increment	9.5	m ³ ·ha ⁻¹	338,272 m ³
Preservation status	well-preserved	60.9	%
	insufficiently stocked	28.3	%
	devastated	10.8	%
Dominantly clean stands	90		43,000 ha
Volume structure	small diameter	14.2	%
	medium-diameter	48.0	%
	large-diameter	37.8	%

Source: Keča and Pajić (2010)

The goal of the article is to research the poplar wood market in Serbia in the commercial sector of P.E. “Vojvodinašume” and sawmill production capacities. The main aim is to obtain the results about capacities of poplar wood, production, channels of distribution, export, etc.

MATERIALS AND METHODS

For the purposes of market research products of poplar wood approached the relevant survey respondents in this field used the technique of interview. The sample in this particular case is representative, because it covers the largest processors of poplar wood in Serbia (Figure 1) and thus the requirement that the pattern faithfully reflects the structure of the study population. As such, they constitute 85% of the market related to the poplar, and the number of participation in the study population in the sample is covered by its significant segment. There have been interviewed 27 processors.

In some cases face to face interviews were conducted (particularly when dealing with the leading companies for poplar wood processing. The response rate was 91%. There have been used open and closed questions (Havelka et al. 1998). The study was focused mainly on small and medium enterprises (SME's), primarily dealing with poplar wood processing, which are at the same time the one of the dominant entrepreneurial orientations in Vojvodina (Marčeta and Keča 2014). In the paper was applied time series analysis through the formulation of trend for statistically significant assortment structure (Morris C. 1996, Keča Lj. 2014). The basis of the research is the product as the element of marketing concept which includes: consumer, an integrated marketing program and profit from satisfied needs of customers (Kotler et al. 2007).

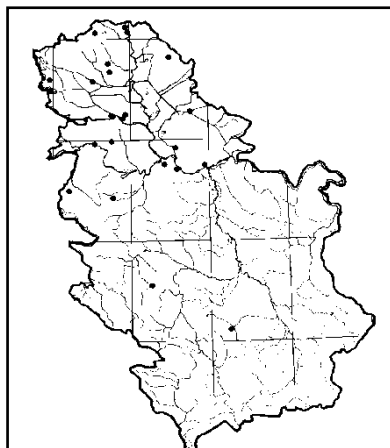

Figure 1. Largest processors of poplar wood in Serbia

RESULTS AND DISCUSSION

By subsidizing of private initiative in Serbia, usage value of poplar wood increases. Besides the production function, it is emphasized ecologic and social forest function, and also multifunctional resource usage.

It is present increase in the last five years in investments and demand assortments of F-class poplar in the Serbian market. In 2012 it amounted to about 38%, and at the beginning of 2008 was about 28%. Placement of L-class products is approximately uniform and is about 10%, while the observed slight decrease in demand for RI-class, a slight increase in the RII-class assortment. In the period from 2008 to 2012 observed a significant reduction in demand for pulpwood in the absence of processing facilities in Serbia. The share of the most valuable classes of assortments (F and L) was increased in the period from 2008 (40%), while in 2012 this share had increased to 53% (Table 2).

Table 2. Quantity of placed poplar wood on the domestic market in the period 2008-2012

Assortment structure	Quantity (m ³)					Σ
	2008	2009	2010	2011	2012	
F	67,507.02	90,181.69	92,520.79	95,795.05	114,865.7	460,870.24
L	29,475.29	36,414.25	32,269.7	36,707.47	49,003.6	183,870.31
RI	58,769.37	70,078.87	56,730.11	68,131.62	63,856.91	317,566.88
RII	27,233.16	44,975.85	29,866.9	42,379.34	45,367.75	189,822.59
RIII	7,095.5	2,439.67	790.25	3,057.75	3,806.85	17,190.02
Pulp wood	55,360.65	43,571.4	30,531.48	27,407.59	31,229.42	188,100.54
Σ	245,441	287,661.7	242,708.8	273,478.8	308,130.2	1,357,420.6

It can be concluded that the Serbian market is a strong need for F-class assortment of poplar and RII- class, which can lead to the conclusion that the processors

are oriented to the production of various products of poplar wood, so the range of products from poplar wood expands, as directed export and for domestic purposes.

Table 3. Elements of regression analysis for statistically significant assortment structure placed on domestic market

F				
Parameter	t	R	F	
a	-2E+07	-4.72644		
b	10,033.07	4.748148	0.939447	22.5449
Y= 10033x - 2E+07				
Pulp wood				
Parameter	t	R	F	
a	1,19E+10	5,030874		
b	-1,2E+07	-5.02812	0.991187	55.98538
c	2938.442	5.025377		
Y= 2938,4x2 - 1E+07x + 1E+10				

Placed poplar wood assortment on domestic market is presented for statistically significant assortment structure: F and pulp wood. Pulp wood placement is presented by a polynomial of the second degree, and F is a linear trend (Figures 2 and 3, Table 3). There is a very strong correlation 0.939-0.991 and the correlation coefficient is statistically significant. The parameters are significant (at error level of $\alpha = 0.05\%$)(Table 3).

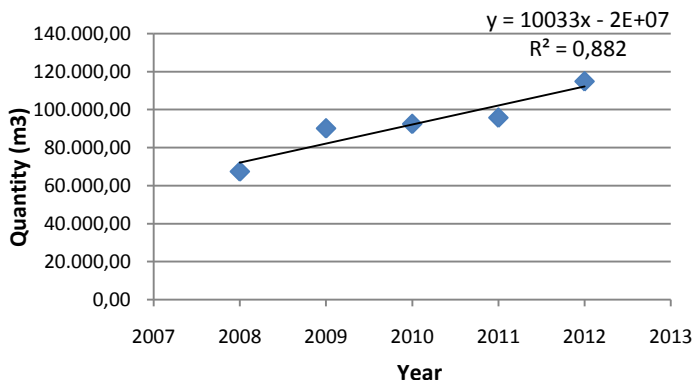

Figure 2. Placement of F assortment structure on domestic market 2008-2012

All processors companies are privately owned. The capacities of all is on average about $17,300 \text{ m}^3 \cdot \text{yr}^{-1}$ ($3,000\text{-}100,000 \text{ m}^3 \cdot \text{yr}^{-1}$), and the utilization of the installed capacities is app. 66% (30-90%).

The main products of the companies, according to the physical volume of production are: timber, boards, lumber, crates and veneer, fiberboard and particleboard. It can be observed that the processors are oriented to the production of multiple products at the same time, so they have installed capacity for multimodal aspect of production and processing of wood, only 6 processors are oriented towards the production of one type of product.

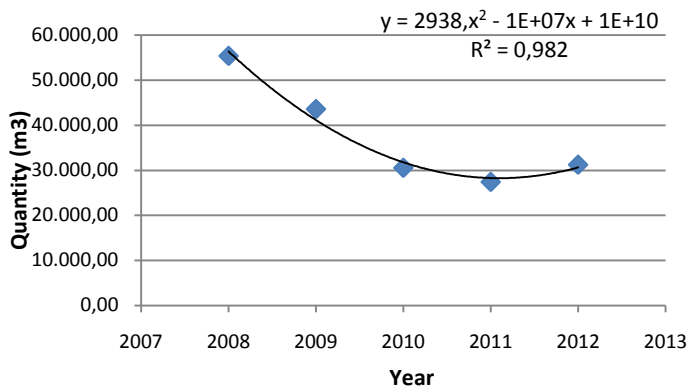

Figure 3. Placement of pulp wood on domestic market 2008-2012

Surveyed 27 companies purchased a total of approximately 282,000 m³ of poplar annually, which is about 90%. This means that the placed 314,000 m³ of poplar wood by PE "Vojvodinašume" sold 282,000 m³ or 90% within the surveyed 27 companies for processing of poplar wood. The remaining 10% (about 32,000 m³) was placed to smaller processors and consumers (backyard sawmills, individual customers, local residents, etc.). Of the 27 respondents, only 15 distribute its products in domestic market. The most common products are: boards, lumber, pallets, and veneer (Table 4).

Table 4. Placement of all poplar wood products on domestic market

Placement	Unit	2008	2009	2010	2011	2012
Boards	m ²	310	7,330	2,510	4,402	2,560
Lumber	m ³	9,390	8,305	4,650	6,032	7,090
Pallets	pieces	327,180	326,180	346,700	389,510	504,630
Pallet elements	m ³	7,200	9,090	9,020	6,515	4,620
Packing boxes	pieces	1,290	530	1,120	1,600	2,200
Veneer	m ³	0	0	0	0	3,000
Fiberboard and particleboard	m ²	10,000	10,000	10,000	16,000	19,200

As opposed to the domestic placements hardboard and plywood market in foreign markets is the placement of these products increased slightly, at the same time is observed and the growth boards of different types of placement (Table 5) (almost 14 times higher in the 2008-2012).

As opposed to the placement of pallet element in the domestic market, this recorded a decline, in the export program on a staggering pace. Also noted was an increase in placement veneer on the international market, a particular growth recorded elements of the crates. Moderate growth records also lumber. It can be concluded that the international market is expanding following products: hardboard, panels, veneer, elements in the crates. Pallet elements recorded a slight decline, and lumber slight increase.

PROCEEDINGS
International Conference **REFORESTATION CHALLENGES**
03-06 June 2015, Belgrade, Serbia

Table 5. Placement of all poplar wood products on foreign market

Placement	Unit	2008	2009	2010	2011	2012
Boards	m ²	0	1,254	8,480	10,122	14,064
Lumber	m ³	5,400	5,607	5,702	5,886	8,490
Elements of boxes	pcs	14,534,898	20,591,522	26,765,793	24,370,760	31,100,020
Pallet elements	m ³	720	406	11,395	29,972	24,565
Packing boxes	m ³	17,285	14,624	24,013	25,865	29,900
Veneer	m ³	8,700	9,937	8,271	7,680	21,823
Fiber- and particleboard	m ²	18,000	18,000	18,000	19,500	21,600

Of all the respondents, on the international market are sold finished products made of poplar wood, mostly to: Italy, Slovenia, Croatia and Greece. Most are exported following products: elements for pallets, elements and floors of boxes, hardboard, panels, lumber, and veneer.

Some processors of poplar have a long tradition in wood processing (over 120 years) and the number of employees that are located at a high level, over 350 employees. One of the respondents collectives with 350 employees represent successfully privatized companies, which managed to go through a successful business, and deals with, among other activities, and processing of poplar wood. The fact that they were on the road, best demonstrated by the data to be from one month to increase production, and $\frac{3}{4}$ of products are exported to the European Union.

Table 6 shows the most important internal (strengths and weaknesses) and external (opportunities and threats) factors analyzed business enterprises, separated based on the attitudes of respondents.

Table 6. SWOT analysis

<p style="text-align: center;">S (strengths)</p> <ul style="list-style-type: none"> • proximity of raw materials • position of the company • the existence of significant capacities in company • quality of products • many years of experience in business 	<p style="text-align: center;">W (weaknesses)</p> <ul style="list-style-type: none"> • low degree of product finalization • outdated machinery • unused capacities • lack of skilled labor in the sphere of management
<p style="text-align: center;">O (opportunities)</p> <ul style="list-style-type: none"> • demand exceeds supply • innovations in mechanization and production process • formation of associations • contribution to the development of the local community 	<p style="text-align: center;">T (threats)</p> <ul style="list-style-type: none"> • difficulty in paying products • heavy tax burden • impossibility of obtaining raw materials of adequate quantity and quality • lack of adequate SME Policy

Major power of companies is reflected in the vicinity of raw materials base and the supplier too. In addition, the company has a very good, specially designed territorial positioning. Weaknesses with which generally meet enterprises engaged in processing of poplar wood in the fact that the finalization of the products is at relatively low level, which dramatically reduces its potential market value. The most important chances are reflected

in longstanding market stability and practice where demand greatly exceeds supply. Illiquid market and the problem of charging for products represent a basic threat (Table 6) Serbian SMEs account for 99% of active companies, which have the potential to contribute significantly to the revival of economic activities, of which the largest are the "micro" enterprises and entrepreneurs account for 96.3% of their total number (2014/a). For a successful business, during 2008 were awarded several companies, which directly affect the product quality, export-oriented enterprises, increasing employment in the wood processing sector. National Investment Plan for 2007 several companies involved in the processing of poplar wood were awarded (support *Greenfield* investment). During 2007 invested 7.2 million € from the National Investment Plan with seven companies that are opening new units in Serbia employed 3,099 workers. During this period, it invested about 60.8 million €. Among them are the two companies engaged in wood processing.

Most foreign owners of processing capacity directed towards the production of environmentally-oriented processing, increasing the total capacity of the company, more efficient marketing of products made of poplar (Stanton et al. 2002) wood in the market and a better quality product. This is indirect impact on better employment in this sector of the economy. During the survey identified the facts that point to a particular occurrence between the seller and buyer. In fact, all of the processors poplars are united in the opinion that the raw material (poplar) expensive in the domestic market. Prices of poplar logs are higher than in Romania and about 20% over than in Hungary. Another disadvantage relates to the classification of wood, which in the opinion of processors of has not implemented the most appropriate. To become more competitive with its products in the domestic market processors are expressing the need for changes in fiscal policy (branch such classification). This mostly applies to processors who in their assortment favor packaging, disposable (VAT on these products is 18%). To become more competitive in the domestic market, change should be moving in the direction of the transformation of the credit-development policy towards accumulative skills activities (provision of soft loans to processors of poplar wood), then in the direction of tariff policies (subsidized the import of equipment for the performance of activities, prohibitions of the entire exports of raw materials), as well as legislation and obligations of control expanded reproduction in forestry (reforestation). Appeared on the market and so small "backyard sawmills", whose owners do not pay taxes and competition are registered processors. They also placed a raw material for so-called "dumping" prices, and are therefore the threat of legal processors poplar wood.

CONCLUSIONS

From the conducted analysis it can be concluded following:

- all processors companies for poplar wood processing are privately owned. The capacities of all is on average about $17,300 \text{ m}^3 \cdot \text{yr}^{-1}$ ($3,000\text{-}100,000 \text{ m}^3 \cdot \text{yr}^{-1}$), and the utilization of the installed capacities is app. 66% (30-90%);
- Serbian market is a strong need for F-class assortment of poplar and RII- class, which can lead to the conclusion that the processors are oriented to the

- production of various products of poplar wood, so the range of products from poplar wood expands, as directed export and for domestic purposes;
- Placed poplar wood assortment on domestic market is presented for statistically significant assortment structure: F and pulp wood. Pulp wood placement is presented by a polynomial of the second degree, and F is a linear trend. There is a very strong correlation 0.939-0.991 and the correlation coefficient is statistically significant.
 - the main products of the companies, according to the physical volume of production are: timber, boards, lumber, crates and veneer, fiberboard and particleboard. It can be observed that the processors are oriented to the production of multiple products at the same time;
 - surveyed 27 companies purchased a total of approximately 282,000 m³ of poplar annually, which is about 90%;
 - only 15 processors distribute its products in domestic market. The most common products are: boards, lumber, pallets, and veneer;
 - in the international market is expanding following products: hardboard, panels, veneer, elements in the crates. Pallet elements recorded a slight decline, and lumber slight increase;

In the future should be directed wood-processing organizations to better adapt to their operational and development plans of production in accordance with the planned cuttings in forestry and widening capacities. Plantations should be established to meet the demands of the market of poplar wood, especially in Serbia, then the markets in the region. In the market for a long time there is a great demand for a veneer logs and saw logs, as the producers as a goal the provision of these assortments.

REFERENCES

- (2014/a): A draft strategy for the development of entrepreneurship and competitiveness for the period 2014-2020 (http://www.privreda.gov.rs/UserFiles/File/1_PRIVREDA/Nacrt-strategije-preduzetnistvo-konkurentnost-9_6_2014.pdf)
- Banković S., Medarević M., Pantić D. (2008). Nacionalna inventura šuma Republike Srbije, Ministarstvo poljoprivrede, šumarstva i vodoprivrede Republike Srbije - Uprava za šume, Beograd (248)
- Havelka N., Kuzmanović B. and Popadić D. (1998). Methods and techniques of social psychological research - Manual for the exercise of social psychology and social psychology II. Belgrade: Centre for Applied Psychology Serbian Psychological Society of Serbia, Belgrade, 1-135 pp.
- Herpka I. et al. (1986). Topole i vrbe u Jugoslaviji, Institut za topolarstvo Novi Sad (152-178)
- Janse G., Ottitsch A. (2005). Factors influencing the role of Non-wood Forest Products and Services. Forest Policy and Economics 7(3): 309-319.
- Keča Lj., Pajić S. (2010). Financial Aspects of Restoration in Poplar Plantations with Technology of Full Ground and Soil Preparation, Global Change, challenges for Soil Management, Advances in Geoecology No. 41., Editor Miodrag Zlatić, Catena Verlag GMBH, (321-334)
- Keča Lj., Keča N., Pajić S. (2011). Investment Appraisal of Poplar Plantations in Serbia, Baltic Forestry, 17 (2): 268-279.

PROCEEDINGS
International Conference **REFORESTATION CHALLENGES**
03-06 June 2015, Belgrade, Serbia

- Keča Lj. (2014). Ekonomika šumarstva, Praktikum sa izvodima iz teorije i rešenim zadacima, Univerzitet u Beogradu, Šumarski fakultet, Planeta print (142)
- Kotler F., Vong V., Sonders Dž., Armstrong G. (2007). Principi marketinga, Mate (932)
- Marčeta M., Keča Lj. (2014). Analysis of Sale of Non-Wood Forest Products from Northern Serbia on the Domestic and Foreign Markets. *Baltic Forestry* 20(1), 115-130.
- Morris C. (1996). *Quantitative Approaches in Business Studies*. Pitman Publishing, UK (139-307)
- Stanton B., Eaton J., Johnson J., Rice D., Schuette B., Moser B. (2002). Hybrid poplar in the Pacific Northwest: The effects of market-driven management, *Journal of Forestry* 100(4) (28)

Session 2:

STOCKTYPES AND SEEDLINGS QUALITY

**INOCULATION OF *ROBINIA PSEUDOACACIA* L. AND *PINUS SYLVESTRIS* L.
SEEDLINGS WITH PLANT GROWTH PROMOTING BACTERIA CAUSES INCREASED
GROWTH IN COAL MINE OVERBURDEN**

**Karličić Vera*, Radić Danka, Jovičić Petrović Jelena, Golubović-Ćurguz Vesna, Kiković
Dragan, Raičević Vera**

*Corresponding author: karlicicvera@gmail.com

Karličić V., Radić D., Jovičić Petrović J., Golubović-Ćurguz V., Kiković D., Raičević V. (2015). Inoculation of *Robinia pseudoacacia* L. and *Pinus sylvestris* L. seedlings with plant growth promoting bacteria causes increased growth in coal mine overburden. In: Ivetić V., Stanković D. (eds.) Proceedings: International conference Reforestation Challenges. 03-06 June 2015. Belgrade, Serbia. Reforesta. pp. 42-49.

Abstract: Plant growth promoting bacteria (PGPB) inhabit plant roots and their rhizospheres and may represent a satisfying alternative to chemical fertilizers and pesticides. In agriculture, PGPR are commonly used, while research in forestry is much less present. One-year-old black locust seedlings and two-year-old container-grown Scots pine seedlings were outplanted into polyethylene bags filled with overburden from Serbia's Kolubara coal mine under nursery conditions. One half of the seedlings of each species were inoculated with four bacteria that were previously characterized as PGPB by a series of biochemical tests. Inoculum contained $\log 8$ colony-forming units (cfu) ml^{-1} of each bacterial strain. Two standardized identification systems (API 50 CH and API 20NE) identified those bacteria as *Bacillus licheniformis*, *Aeromonas hydrophila*, *Pseudomonas putida* and *Burkholderia cepacia*. At the end of the growing season inoculated black locust seedlings were 16% taller and had 13% more root-collar diameter than un-inoculated seedlings. For Scots pine seedlings, the increase of height was not significant but root-collar diameter showed a 12% increase. These results indicate the potential for using PGPB to enhance growth of black locust and Scots pine when outplanted into coal mine overburden.

Key words: PGPR, black locust, Scots pine, coal mine overburden.

INTRODUCTION

Kolubara mining basin (Lazarevac district, Serbia) is the biggest and one of the most important energy sources in Serbia. Since coal mining is a temporary use of land, the ecosystem reclamation is obligatory. Ecosystems have ability to recover themselves through spontaneous successions but that requires a lot of time. Consequently seedling become usual practice in rehabilitation of post-mining landscapes (Tischew et al. 2008).

Biological reclamation demand caution in plant selection due to unfavorable substrate conditions for many tree species (Rakić et al. 2011). One of the main problems

of areas scheduled for reclamation is the fact that fertile layer of soli is lost permanently (Rakić et al. 2011). Those newly formed substrates represent deposits of overburden which mechanical characteristics vary widely and that affects all other substrate characteristics (water capacity, aeration, and filtration speed). Humus content higher than 1% occurs rarely (Rakić et al. 2011) and that impede restoration of vegetation (Tischew et al. 2008).

Establishment of stabile vegetation on such substrates is a challenge and new approach which considers application of soil microorganism may lower down needed efforts. A lot of bacteria that inhabit plant roots and their rhizospheres have potential to promote plant growth and they are well known as plant growth promoting bacteria (PGPB) (Mohite 2013). The interest for PGPB grew in parallel with interest for biological approaches in endeavor to improve crop productivity without chemicals (fertilizers, pesticides) (Rossas et al. 2009, Dasatger et al. 2011). Literature data emphasize the effects of tree inoculations with PGPB on shoot and root weights, root growth and morphology, germination rates, leaf area, chlorophyll content, magnesium, nitrogen and protein content, tolerance to drought, salt, heavy metals stress (Lucy et al. 2004, Jing et al. 2007). Increases in shoot and root length and weight are commonly reported responses to PGPB inoculations (Vessey 2003, Ramos et al. 2003, Gujaničić et al. 2012).

The exploited area in Kolubara mine basin is around 16,000 ha of which 3,395 ha are overburden waste dumps but reclamation has been carried out on only 882 ha (Jakovljević et al. 2015). Previous recultivation activities employed tree species that tolerates a variety of soils and grows predominantly on poorer substrates such as black pine, Scots pine, European larch, European ash, Small-leaved Lime, black locust (Veselinović and Golubović- Ćurguz 2003, Rakić et al. 2011).

In our study we used black locust (*Robinia pseudoacacia* L.) and Scots pine (*Pinus sylvestris* L.) which are extensively used for afforestation of strip-mined land, erosion control and are already present on Kolubara's reclaimed areas.

The first step was *in vitro* assessment of PGP potential of several bacterial stains. After that, their potential was tested in *in vivo* experiment with black locust and Scots pine seedlings. The aim was to evaluate the field performance of seedlings inoculated with selected PGPB and replanted in overburden from coal mine Kolubara, under nursery conditions.

MATERIALS AND METHODS

Bacterial isolates

Thirty isolates were obtained from the collection of the laboratory for microbial ecology, University of Belgrade - Faculty of Agriculture, Zemun, Serbia. Pure bacterial cultures were maintained on their respective slants until further testing.

PGP features of isolates

Bacterial isolates were tested for the production of ammonia in peptone water (Cappuccino and Sherman 1992). Indole-3-acetic acid (IAA) like compounds were detected as described Brick et al. (1991). Siderophore production was detected on CAS agar plates

(Schwyn and Neilands 1987). Phosphate solubilizing capacities of isolates were examined on National Botanical Research Institute's phosphate growth medium (NBRIP) (Nautiyal 1999).

Antagonistic activity of the isolates towards plant pathogen was tested on *Botrytis cinerea* and *Pythium aphanidermatum* by dual test. A 5 mm size square mycelia plug of pathogen was placed on Potato dextrose agar (PDA), and bacterial cells were applied in line shape approximately 3 cm away of plug. PDA plates inoculated only with *B. cinerea* or *P. aphanidermatum* were used as controls. Incubation at 25°C lasted until radial growth of pathogen on control plates stopped. The levels of inhibition were calculated by subtracting the control radius and pathogen radius towards bacteria in dual plates. Experiments were performed in triplicate.

Identification of PGP isolates

Isolates with promising PGP attributes were identified to species level by API20NE and API50CH kits (bioMérieux, France) following the manufacturer's instructions. The results were analyzed using API software package (APIWeb, Version-1.1.0).

Inoculum preparation

Inoculum was consisted of isolates that showed the most notably PGP attributes. The isolates were grown separately on their respective media. The bacterial suspensions were diluted in sterile distilled water and final concentration was adjusted to 10^8 colony-forming units (CFU) ml^{-1} for each strain. Separate inoculums were mixed together and formed consortia. Inoculation with consortia was conducted at the beginning of the growing season by adding 100 ml of inoculum seedling⁻¹. The same procedure was repeated 12 weeks latter. Un-inoculated plants got 100 ml seedling⁻¹ of distilled water.

Plant and substrate material

Seedlings of black locust (1+0) and Scots pine (2+0) were obtained from Forest Nursery Požega, PE Srbijašume, Serbia and those with similar height and root-collar diameter were selected. Substrates used in the experiment were overburden from coal mine Kolubara and commercial Floradur® Plant Universal (FloraGard, Germany). Overburden has neutral pH value, low content of nitrogen, humus and organic carbon. Prior to use, overburden was air-dried, ground, and sieved through a 2 mm diameter sieve.

Field operations

Experiment had tree treatments: seedlings outplanted into polyethylene bags with commercial substrate (F), seedlings outplanted into overburden (O), and seedlings outplanted into overburden and inoculated with PGPB (OI). The experiment had a completely randomized design and each treatment had four replicates consisted of five plants. Seedlings were planted under nursery conditions and 18 weeks later the first measurement of height and root-collar diameter was conducted. At the end of the growing season, the treatments were harvested and growth parameters (seedling height, root-collar diameter and root length, shoot and root dry biomass) were measured.

Statistical analyses

One-way analysis of variance (ANOVA) was used to analyze data with the SPSS 21 software package (SPSS Inc., Chicago, IL, USA). The least significant differences (LSD: $p=0.05$) was used to separate the treatment means.

RESULTS

Thirty isolates were tested for presence of PGP attributes and twelve isolates had two or more attributes (Table 1).

Table 1. Plant growth promoting attributes of the isolates

PGP strains	Ammonia production	IAA production	Siderophore production	Phosphorus solubilization
1ark	+	-	+	-
2art	+	+++	++	+
3art	-	++	+++	+
4art	+	+	++	++
5arp	-	-	++	++
6arp	+	-	-	+
7arp	+	+	-	-
8ard	+	-	+	+
9ard	+	-	++	-
10ars	+	-	+++	++
11ars	+	+	-	+
12aro	+	-	++	+++

- No production, + low, ++ moderate, +++ high production

Antagonistic activity of the bacterial stains was compared to classification of Sookchaoy et al. (2009) and only isolates with moderate (>51%) and higher antagonistic activity were considered (Table 2).

Table 2. Antifungal activity of the isolates against *Botrytis cinerea* and *Pythium aphanidermatum*

PGP strains	Mycelia radius (mm)	
	<i>Botrytis cinerea</i>	<i>Pythium aphanidermatum</i>
3art	+	-
4art	+	-
6arp	+	-
7arp	++	-
9ard	+++	+
10ars	+	-
11ars	+	-
12aro	+	-

- no antifungal activity, + moderate antifungal activity, ++ high antifungal activity, +++ very high antifungal activity

Four isolates distinguished themselves after those analyses. Isolate 4 art was attributed with the most PGP features compared to others. Isolate 2 art showed the higher IAA production, 9 ard stood up by the highest antagonistic activity in dual tests and final 12 aro had wider halo zone around the colony in plate-based P solubilization test. All promising isolates were positive for siderophore production.

Selected isolates were identified as: *Burkholderia cepacia* (2 art), *Aeromonas hydrophilia* (4 art), *Bacillus licheniformis* (9ard) and *Pseudomonas putida* (12aro).

In vivo experiment was conducted during the growing season 2014 and lasted eight mounts. Un-inoculated seedlings planted in overburden and commercial substrate represents a control. The first measurement were conducted in mid-July and showed that the higher increase of black locust seedlings growth was in inoculated treatment. The first measurement of Scots pine seedlings underlain OI treatment as the most successful (Table 4).

At the end of the experiment, seedlings were collected and black locust seedlings showed the highest seasonal increment in height in treatment OI while treatment O was significantly lower. Comparison of O and OI treatments through other parameters showed that inoculated seedlings had wider collar diameter and shoot dry biomass, while treatment O have a lead in root length. There were not differences among treatments in root dry biomass.

Even thought Scots pine seedlings in treatment OI were higher at the end of the experiment, the differences were not significant. Comparison of OI and O treatment showed that inoculated seedlings had wider collar diameter, root length and shoot dry biomass. No differences were recorded among treatments in root dry biomass (Table 4).

Table 4. Seedlings growth parameters

Plant	Treatment	Start		1 st measurement		2 nd measurement		RL [cm]	SDB [g]	RDB [g]
		H	D	H	D	H	D			
		[cm]	[mm]	[cm]	[mm]	[cm]	[mm]			
<i>Robinia pseudoacacia</i>	F	32.89 ^a	0.57 ^a	56.21 ^a	0.83 ^a	72.07 ^{ab}	1.04 ^a	25.67 ^b	13.6 ^a	15.1 ^a
	O	31.62 ^a	0.54 ^a	47.29 ^b	0.67 ^b	64.62 ^b	0.81 ^b	30.29 ^a	8.99 ^c	5.53 ^b
	OI	32.02 ^a	0.51 ^a	61.62 ^a	0.71 ^b	76.67 ^a	0.93 ^{ab}	25.67 ^b	10.83 ^b	6.4 ^b
<i>Pinus sylvestris</i>	F	7.97 ^a	0.26 ^a	15.73 ^a	0.39 ^b	17.47 ^a	0.42 ^b	30.47 ^{ab}	2.08 ^c	2.08 ^b
	O	8.32 ^a	0.24 ^a	14.9 ^a	0.34 ^b	17.9 ^a	0.43 ^b	28.29 ^b	2.72 ^b	2.96 ^{ab}
	OI	9.05 ^a	0.29 ^a	16.88 ^a	0.43 ^{ab}	18.63 ^a	0.49 ^a	36 ^a	3.58 ^a	3.34 ^a

H - seedling height, Ø - root-collar diameter, RL - root length, SDB – shoot dry biomass, RDB- root dry biomass;

* Data labeled with the same letter are not statistically different at significance level of 0.05

DISCUSSION

Plant growth promotion by soil bacteria is a consequence of different mechanisms which effects either plant nutrition (direct mechanisms) or resistance towards pathogens (indirect mechanisms). Modern tendencies in PGPB application

emphasize the use of mix populations over inoculums consisted of one isolate (Raičević et al. 2010). The consortium used in our study was consisted of members of *Bacillus*, *Aeromonas*, *Pseudomonas*, *Burkholderia* genera well known by its PGP activities (Zhang et al. 1996, Glick 2012).

One of the most interesting mechanisms of PGP action is production of IAA and *Aeromonas hydrophila* and *Burkholderia cepacia* tested in our study were positive for IAA production which is in accordance to literature data (Kerkar et al. 2012, Ji et al. 2010). Selected isolates were positive for siderophore production and the ability of *Bacillus* sp., *Pseudomonas* sp., *Burkholderia* sp. and *Aeromonas* sp. to bind iron and facilitate its absorption was reported by numerous authors (Ahmad et al. 2008, Gamalero and Glick 2011, Bevivino et al. 1998, Murugappan et al. 2006). Also, *P. putida*, *B.cepacia*, *A. hydrophila* used in our study showed ability to solubilize inorganic phosphorus. *B. licheniformis* was the only isolate that showed satisfying antagonistic activity towards both phytopatogens and this species is already recognized as powerful biocontrol agent (Kim et al. 2007).

In our study, inoculation of Scots pine seedlings resulted with significant increase in collar diameter (12%), root length (21%), shoot dry biomass (24%) compared to un-inoculated seedlings. Root dry biomass was 11% higher. Similar results were reported by Gujaničić et al. (2012) after inoculation of Scots pine seedlings with consortium of *Azotobacter chroococcum* and several *Bacillus* isolates (*B. licheniformis* among others). Root length was increased by 23% while this consortium was more successful in term of root dry biomass (increased by 25%). The results obtained by Egamberdiyeva (2005) suggest that positive effects of inoculation may be visible in shorter period of time, even in a few weeks.

At the end of the growing season inoculated black locust seedlings were significantly higher (16%) compared to un-treated control. Root-collar diameter was 13% wider while shoot biomass yield was significantly higher (17%). Differences of root biomasses between treatments were not considerable. The response to inoculation may be visible in much shorter period of time and Hao et al. (2012) reported increase in length and dry weight of shoots and roots of black locust seedlings only 45 days after inoculation with PGP *Agrobacterium tumefaciens*.

The majority of studies that deal with forest trees - microorganism's beneficial interactions are focused on the fungi and mycorrhizae. But, it is proven that PGPB may stimulate the beneficial mycorrhizae associations (Vessay 2003) and enhance the relationship between plant and nitrogen-fixing *Rhizobia* (Loon 2007). Positive effects on growth and biomass production and stimulation of symbiotic associations nominate inoculation with PGPB as potentially good approach in successful biological reclamation of poor, devastated, inhospitable areas, such as overburden waste dumps.

CONCLUSION

Sustainable establishment of new ecosystems in the post-mining areas is the main challenge in efforts to reduce the negative ecological consequences of mining activity. Selection of suitable plant material is highly required and usage of plant-microbe

beneficial interactions may be a proper way to obtain stability. Presented results suggest that selected PGPB have potential to provide a successful growth of tested species and help in recuperation of degraded ecosystems and establishment of their mature stage.

Acknowledgments: *This research was supported by the Ministry of Education and Science of the Republic of Serbia, Grant No. TR 31080 and FP-7 project AREA (316004).*

REFERENCES

- Ahmad F., Ahmad I., Khan M.S. (2008). Screening of free-living rhizospheric bacteria for their multiple plant growth promoting activities, *Microbiological Research*, 163: 173-181.
- Bevivino A., Sarrocco S., Dalmastri C., Tabacchioni S., Cantale C., Chiarini L. (1998). Characterization of a free-living maize-rhizosphere population of *Burkholderia cepacia*: effect of seed treatment on disease suppression and growth promotion of maize. *FEMS Microbiology Ecology*, 27 (3): 225–237.
- Brick J.M., Bostock R.M., Silverstone S.E. (1991). Rapid insitu assay for indole acetic acid production by bacteria immobilized on nitrocellulose membrane, *Applied and Environmental Microbiology*, 57 (2): 535-538.
- Cappuccino J.C., Sherman N. (1992). In: *Microbiology: A Laboratory Manual*, third ed. Benjamin /cummings Pub. Co. New York, 125–179.
- Dastager S.G., Deepa C.K., Pandey A. (2011). Plant Growth Promoting Potential of *Pantoea agglomerans* in Cowpea (*Vigna unguiculata* (L.) Walp.), *Applied Soil Ecology*, 49: 250-255.
- Egamberdiyeva D. (2005). Effect of plant growth promoting bacteria on growth of Scots pine and silver birch seedlings, *Uzbek Journal of Agriculture*, 1 (19): 66-69.
- Gamalero E., Glick R.B. (2011). Mechanisms Used by Plant Growth-Promoting Bacteria, in: *Bacteria in Agrobiology: Plant Nutrient Management*, ed. Maheshwari D. K., (Heidelberg: Springer), 17-46.
- Glick B.R. (2012). Plant Growth-Promoting Bacteria: Mechanisms and Applications, Hindawi Pub. Corporation Scientifica, Article ID 963401, <http://dx.doi.org/10.6064/2012/963401>.
- Gujaničić V., Golubović-Čurguz V., Raičević V., Lalević B., Spasojević I., Kiković D. (2012). Effects of biofertilization on spruce (*Picea abies* L.Karst) and pine seedlings (*Pinus sylvestris* L.) growth in deposol, *International Scientific Conference Forests in future-sustainable use, risks and challenges*, Proceedings, 461-467.
- Hao X., Xie P., Johnstone L., Miller S.J., Rensing C., Weia G. (2012). Genome Sequence and Mutational Analysis of Plant-Growth-Promoting Bacterium *Agrobacterium tumefaciens* CCNWS0286 Isolated from a Zinc-Lead Mine Tailing, *Applied and Environmental Microbiology*, 78 (15): 5384-5394.
- Jakovljević M., Lilić N., Kolonja B., Knežević D., Petrić M., Tadić V., Nedić M. 2015. Biomass production as renewable energy resource at reclaimed Serbian lignite open-cast mines, *Thermal Science*, DOI: 10.2298/TSCI140626014J.
- Ji X., Lu G., Gai Y., Gao H., Lu B., Kong L., Mu Z. (2010). Colonization of *Morus alba* L. by the plantgrowth-promoting and antagonistic bacterium *Burkholderia cepacia* strain Lu10-1, *BMC Microbiology*, 10:243
- Jing Y., He Z., Yang X. (2007). Role of soil rhizobacteria in phytoremediation of heavy metal contaminated soils, *Journal of Zhejiang University-SCIENCE B*, 8(3): 192–207.
- Kerker S., Raiker L., Tiwari A., Mayilraj S., Dastager S. (2012). Biofilm-associated indole acetic acid producing bacteria and their impact in the proliferation of biofilm mats in solar salterns, *Biologia*, 67 (3): 454-460.

- Kim J.H., Lee S.H., Kim C.S., Lim E.K., Choi K.H., Kong H.G., Kim D.W., Lee S.W., Moon B.J. (2007). Biological control of strawberry gray mold caused by *Botrytis cinerea* using *Bacillus licheniformis* N1 formulation, *Journal of Microbiology and Biotechnology*, 17(3): 438-44.
- Loon L.C. (2007). Plant responses to plant growth-promoting rhizobacteria, *European Journal of Plant Pathology*, 119: 243–254.
- Lucy M., Reed E., Glick B.R. (2004). Applications of free living plant growth promoting rhizobacteria. *Antonie Van Leeuwenhoek* 86: 1-25.
- Murugappan R.M., Rekha S., Thirumurugan R. (2006). Characterization and quantification of siderophores produced by *Aeromonas hydrophila* isolated from *Cyprinus carpio*, *Pakistan Journal of Biological Sciences*, 9: 437-440.
- Mohite B. (2013). Isolation and characterization of indole acetic acid (IAA) producing bacteria from rhizospheric soil and its effect on plant growth. *Journal of Soil Science and Plant Nutrition*, 13 (3): 638-649.
- Nautiyal C.S. (1999). An efficient microbiological growth medium for screening phosphate solubilizing microorganisms, *FEMS Microbiology Letters* 170: 265-270.
- Raičević V., Lalević B., Kljujev I., Petrović J. (2010). *Ekološka mikrobiologija*, Poljoprivredni fakultet, Beograd, ISBN 978-86-7834-091-8.
- Rakić A., Filipović V., Rakić I., Racić Z., Vasiljević V., Obradović D. (2011). Rekulativacija odlagališta pepela i šljake PD RB Kolubara i TE Veliki Crljeni – Izvođenje radova na terenu, II Simpozijum sa međunarodnim učešćem “Rudarstvo 2011”- Stanje i perspektive u rudarstvu i održivi razvoj, 10-13 maj, Vrnjačka Banja, Zbornik radova, 552-555.
- Ramos B., Lucas Garcia J.A., Probanza M., Barrientos L., Gutierrez Manero F.J. (2003). Alterations in the rhizobacterial community associated with European alder growth when inoculated with PGPR strain *Bacillus licheniformis*, *Environmental and Experimental Botany*, 49 (1):61-68.
- Rosas S.B., Avanzini G., Carlier E., Paslousa C., Pastor N., Rovera M. (2009). Root colonization and Growth Promotion of Wheat and Maize by *Pseudomonas Aurantiaca* SR1, *Soil Biology and Biochemistry*, 41 (9): 1802-1806.
- Schwyn B., Neilands J.B. (1987). Universal chemical assay for the detection and determination of siderophores, *Analytical Biochemistry*, 160 (1): 47-56.
- Sookchaoy K., Panthachode S., Thipchu J. (2009). Screening of *Trichoderma* spp. for *Phytophthora* root and foot rot on *Citrus sinensis* biocontrol, *International Conference on the Role of Universities in Hands-On Education*, 23-29 August, Thailand, 356-362.
- Vessey J. K. (2003). Plant growth promoting rhizobacteria as biofertilizers, *Plant and Soil*, 255: 571–586.
- Tischew S., Kirmir A., Lorenz A. (2008). Alternative restoration strategies in former lignite mining areas of eastern Germany, In *Biodiversity: Structure and Function*, Vol. 22, eds. Barthlott, W., Linsenmair, K.E., Porembski, S., in *Encyclopedia of Life Support Systems (EOLSS)*, Developed under the Auspices of the UNESCO, Eolss Publishers, Paris, France.
- Veselinović M., Golubović-Čurguz V. (2003). Recultivation by afforestation of deposols, *Zemljište i biljka*, 50 (3): 201-210.
- Zhang F., Dashti N., Hznas R.K., Smith D.L. (1996). Plant growth promoting rhizobacteria and soybean [*Glycine max* (L.) Merr.] Nodulation and Nitrogen Fixation at Suboptimal Root Zone Temperatures, *Annals of Botany*, 77: 453-459.

EFFECTS OF SPACING BLACK LOCUST (*ROBINIA PSEUDOACACIA* L.) SEEDLINGS IN STRIPES ON MORPHOLOGICAL CHARACTERISTICS AND YIELD PER UNIT AREA

Kolevska Dana Dina, Trajkov Pande, Maletic Vladimir

*Corresponding author: dkolevska@sf.ukim.edu.mk

Kolevska D.D., Trajkov P., Maletic V. (2015). Effects of spacing black locust (*Robinia pseudoacacia* L.) seedlings in stripes on morphological characteristics and yield per unit area. In: Ivetić V., Stanković D. (eds.) Proceedings: International conference Reforestation Challenges. 03-06 June 2015, Belgrade, Serbia. Reforesta. pp. 50-59.

Abstract: The aim of this study was to investigate the effects of growing one year-old black locust seedlings (*Robinia pseudoacacia* L.) in stripes of 3 and 4 rows, on morphological characteristics. As a control, seedlings were raised in single rows, 20 cm apart (VAR 1). The stripes (belts) were formed of 3 rows 4 cm apart, distance between stripes 20 cm (VAR 3), and of 4 rows 4 cm apart, distance between stripes 30 cm (VAR 4). Seedlings were grown in seedbeds with three replications.

The height (SH) and root collar diameter (RCD) of the seedlings have been measured. The number of first order lateral roots (FOLR), distribution of seedlings in height and thickness classes, coefficients of correlations of morphological and growing parameters and yield of qualified seedlings per unit production area were analyzed.

The seedlings of VAR 1 and VAR 3 had the highest SH, RCD and FOLRN. They had more favorable distribution in height and thickness classes than the seedlings of VAR 4. Yield of usable I and II quality class seedlings per a unit production area of VAR 3 and VAR 4 was 252-255% higher than VAR 1 (control). Growing black locust seedlings in stripes of 3 rows results in favorable seedling quality and increased yield per production unit area.

Key words: *Robinia pseudoacacia* L., stripes, seedlings, morphology, yield.

INTRODUCTION

The black locust is an allochthonous but well adapted species in Macedonia. Even though black locust prefers warm climate, in Macedonia it is spread on almost all its territory in wide range of altitude between c/a 50-1,300 m a.s.l. Its high adaptability to various ecological conditions and capability of easy vegetative regeneration allow this species spread spontaneously, penetrating into urban and protected areas playing role of invasive plant (Kolevska and Acevski 2005, Kolevska and Velkovski 2009). Black locust for its bio-ecological features is used in Macedonia mostly for ameliorative purposes, especially for stabilization of erosive areas, for afforestation of barren lands, reclamation of waste land etc. (Trendafilov et al. 2009). However, in Macedonia there haven't been established any energetic or timber plantations yet, which is not the case in other countries where this species is very important for establishing short-rotation biomass

energy plantations, for production of biomass as a renewable resource for bioenergy etc. (Rédei et al. 2002, Mantovani et al. 2014).

Black locust is the most common broadleaved species grown in nurseries in Macedonia. Annually, about 2-3 mil. 1+0 bareroot seedlings (85% of all broadleaves species produced) are grown (Kolevska 2005). Even though black locust seedlings can be produced as containerized (Kostopoulou et al. 2011, Dini-Papanastasi et al. 2012), in Macedonia they are grown only as bare-root. The average production area of the nurseries is quite small (0.5-5 hectares) therefore all nursery operations, with the exception of mechanical soil preparation, as seedbeds preparation, sowing, covering, cultivation and weeding are carried out manually.

The black locust seed is usually sown on seedbeds or, rarely, directly on production area without seedbed preparation. If in seedbeds, the seed is sown into single rows, perpendicularly to the long side of the seedbed. The distance between rows is usually 20-30 cm. Such nursery practice generally provides seedlings which meet required standard demands. However, manual labor, especially for weed removal, raises the costs of the seedlings. Increasing seedlings density is one of the ways to overcome this problem. Density and spacing, i.e. seedling distance within and between rows, determines the yield from the production area (van der Driessche 1984, Mexal and Landis 1990), but also the degree of the competition between seedlings for light, nutrients and water (Semerci et al. 2008, Yücedağ and Gailing 2012, Dini-Papanastasi et al. 2012).

Stripes represent a pattern of seedling spacing common in some nurseries with big production area and mechanical nursery equipment for seeding, cultivation, weed removal, seedlings lifting etc. The seedbeds are not established and the sowing is performed directly on the production area. The stripes consist mostly of 2-6 rows with different distance between rows within a single stripe and between stripes, or the seeds are sown evenly over the whole width of the stripe. The stripes are usually 5-20 cm wide. This way of spacing enables bigger seedling production per unit while performing the same quantity of maintain operations (Байтулин 2009, Алыбеков 2013, Dušek 1997, Илиев et al. 2014, Anonymous 2012).

The aim of this study was to investigate whether growing black locust seedlings in stripes would increase seedlings production per unit production area and affect seedling quality required according to Macedonian quality standards.

MATERIAL AND METHOD

The experiment was conducted in the nursery of PE "Macedonian forests", Forest Estate in Demir Kapija. The nursery lies on flat terrain at about 107 m a.s.l. (41°24.845' N, 22°14.293' E). The average year air temperature is 13.8° C, while average for vegetation period (April-October) is 19.6° C. The average annual sum of precipitations is 587 mm. The soil is sandy-clay, about 50 cm deep.

Following variants were established in the experiment:

Variant 1 – control (VAR 1): the seed was sown on regular way, in single rows about 1 cm wide. The distance between rows was 20 cm.

Variant 3 (VAR 3): the seed was sown in stripes of 3 grouped rows, the distance between rows within a stripe was 4 cm+1 cm of row, i.e. one stripe was c/a 11 cm wide. The distance between stripes was 20 cm.

Variant 4 (VAR 4): the seed was sown in stripes of 4 rows, the distance between rows was 4 cm+1 cm of row, i.e. one strip was c/a 16 cm wide. The distance between stripes was 30 cm.

Each variant of the experiment had 3 replication of 4 m².

The seedbeds were prepared by mechanical ploughing and manual shredding (harrowing). The seedbed was 1 m wide. The seeds of black locust were collected from trees near Demir Kapija (to the date the seed source was not recognized and registered yet). The seed purity was 82%, germination 63% and weight of 1,000 seeds 17.8 g. One day prior the sowing the seed was immersed for 20 seconds in boiling water then cooled in cold water few seconds and left for 24 hours in lukewarm water (Stamenkov and Kolevska 2000). Then the seed was slightly dried, treated with Cineb and sown. About 2.0-2.2 g dry seed (on the base of the volume of prepared seed) was sown evenly per 1 meter of row. The sowing was performed manually into rows, transversely oriented to the axis of the seedbed. A wooden device was used to ensure even depth and distance between rows in stripes and between stripes. Depth of the rows was 2 cm and the seed was covered with soil. The seedbeds were maintained moderately moist for all the period of germination. After emerging of the germinants and during the growing season weeds removal and soil cultivation were performed manually 3 times (May, June, July). The seedlings were watered by demand and treated twice with Benomil. No measures of thinning of young seedlings and fertilization were carried on.

At the end of October seedlings were lifted for analyzes. Randomly, of each replication were lifted: all seedlings of 2 rows x 3 replications i.e. totally of 6 rows of the VAR 1 (control); all seedlings of 1 stripe of 3 rows x 3 replications of the VAR 3; all seedlings of 1 stripe of 4 rows x 3 replications of the VAR 4. Total of 889 seedlings were measured. An average number of seedlings per row (single row and rows within a stripe) were counted.

Following parameters of seedling were measured: seedling height (SH, ± 0.5 cm; from the root collar to the top of the shoot); root collar diameter (RCD, ± 0.1 mm); number of first order lateral roots of any thickness (FOLR) to the depth of 10 cm. FOLR were visually estimated whether their thickness is proportional or un-proportional in relation to RCD, i.e. thickness of the tap root, of the seedling. The participation of seedlings with roots of II and higher orders was recorded.

Data analyses were performed using SPSS program for windows, version 20.0. One-way ANOVA was carried on to determine whether the means of seedlings' morphological features were equal and Tukey's HSD test with significance level of $p < 0.05$ ($\alpha = 0.05$) to separate differences. Comparison of root features between seedlings of different variants was carried on by Pearson's χ^2 test. Pearson's coefficient of correlation (R) and coefficients of determination R^2 were calculated for some morphological traits of the seedlings.

RESULTS

Morphological traits of the shoot of the seedlings

The SH and RCD of all variants vary in wide range (Table 1). The highest mean of SH and RCD have control seedlings (VAR 1) grown in single rows. The seedlings of VAR 3, compare to VAR 1, have lower height and significantly lower RCD. Grouping 4 rows into one stripe (VAR 4) decreases significantly SH and RCD. The average number of seedlings per row (n) also varies: stripes of 4 rows (VAR 4) contained significantly bigger number of seedlings per 1 m of row. Due to wide range between min and max of SH and RCD (207 cm for SH, 14.8 mm for RCD), in Table 2 and Table 3 is presented distribution of seedlings in height and thickness classes (I, II class, i.e. qualified seedlings) and cull seedlings, according to Macedonian quality standards (MKS D.22.112, 1968) for 1+0 black locust seedlings.

Table 1. Minimum, maximum, mean values and standard deviation (SD) of black locust seedlings' morphological traits. VAR = variant; N = total number of analyzed seedlings; n = average number of seedlings per row (single row and rows within a stripe); SH = shoot height; RCD = root collar diameter. Means within column with different letters are significantly different at $p < 0.05$.

VAR	N	n	SH [cm]				RCD [mm]				SH:RCD [cm:mm]
			min	max	mean	SD	min	max	mean	SD	
1	158	26.3 ^b	15.0	216.0	75.16 ^b	46.61	1.2	15.6	5.05 ^b	3.40	15.42 ^a
3	243	29.0 ^b	11.0	187.0	70.89 ^b	38.95	0.8	13.5	4.15 ^a	2.68	16.95 ^a
4	488	40.7 ^a	9.0	156.0	58.04 ^a	35.13	0.9	12.4	3.53 ^a	2.21	16.61 ^a

Table 2. Distribution of seedlings in height classes. VAR = variant, N = total number of analyzed seedling, cn = number of seedlings in height class.

Class of height by MKS (cm)	VARIANTS					
	VAR 1		VAR 3		VAR 4	
	cn	%	cn	%	cn	%
I (>40)	112	70.9	184	75.8	292	59.8
II (25-39.9)	32	20.3	43	17.8	114	23.3
culls (<24.9)	14	8.8	16	6.4	82	16.9
N	158	100.0	243	100.0	488	100.0

Table 3. Distribution of seedlings in thickness classes. VAR = variant, N = total number of analyzed seedlings; cn = number of seedlings in thickness class.

Class of thickness by MKS (mm)	VARIANTS					
	VAR 1		VAR 3		VAR 4	
	cn	%	cn	%	cn	%
I (>4.0)	78	39.2	99	40.8	120	24.5
II (3.0-3.9)	18	11.4	47	19.1	115	23.6
culls (<2.9)	62	49.4	97	40.1	253	51.8
N	158	100.0	243	100.0	488	100.0

Distribution of seedlings in quality classes in term of RCD is less favorable, i.e. within all variants participation of cull seedlings is high, c/a 40-50%. VAR 3 produced the highest number of seedlings in I and II class of height. The results are close to VAR 1, while

VAR 4 has the least number of seedling in I class of height and highest number of cull seedling.

Characteristics of the root system of the seedlings

In Table 4 are presented data of root systems of the seedlings. The average number of roots per seedling, despite significant differences between VAR 1 and VAR 3 on one side, and VAR 4 on the other side, in fact varies in rather narrow range. Significant differences between variants in term of presence of seedlings with roots of II and higher orders were recorded. Grouping rows in a stripe affects the II and higher order roots development.

Table 4: Minimum, maximum, mean and standard deviation (SD) of the number of first order lateral roots (FOLR) per seedling; presence of seedlings with roots thickness proportional to RCD; presence of seedlings with roots of II and higher orders. VAR = variant, N = total number of analyzed seedlings; n = average number of seedlings per row (single row and rows within a stripe); Means within column with different letters are significantly different at the $\alpha=0.05$ level. Pearson's χ^2 test for presence of seedlings with roots thickness proportional to RCD and for the presence of seedlings with roots of II and higher orders: Data within columns with different letters are significantly different at $p < 0.05$.

VAR	N	n	FOLR/seedling				Root thickness proportional to RCD		seedlings with roots of II and higher orders	
			min	max	mean	SD	%	%		
1	158	26.3	1	22	5.54 ^b	4.19	53.2 ^c	21.1 ^b		
3	243	29.0	1	21	5.33 ^b	3.93	40.8 ^b	16.3 ^b		
4	488	40.7	0	18	4.17 ^a	3.32	33.4 ^a	8.7 ^a		

Coefficient of correlation and determination

Table 5: Coefficients of correlation (R) and determination (R^2) between morphological traits and number of seedlings per row. SH = shoot height, RCD = root collar diameter. FOLR = first order lateral roots number; n = average number of seedlings per row (single row and rows within one stripe). Marked correlations are significant at $p < 0.05$ (*) and $p < 0.01$ (**).

Pairs	Variant 1		Variant 3		Variant 4	
	R	R^2	R	R^2	R	R^2
SH:RCD	0.95**	0.90	0.92**	0.84	0.90**	0.81
RCD: FOLR	0.70*	0.49	0.79*	0.62	0.68*	0.46
n:SH	-0.87*	0.76	0.56*	0.31	-0.59*	0.34
n:RCD	-0.79*	0.62	0.48*	0.23	-0.74*	0.54
n: FOLR	-0.66*	0.44	0.27	0.07	-0.64*	0.41

Correlation between morphological traits of the seedlings (Table 5) reflects mostly expected dependence, in terms of the direction and the degree of correlation. R between density of the seedlings (number of seedlings in a single row and in rows within stripes) and morphological traits of the seedlings, in the case of VAR 1 and VAR 4 has similar degree and negative direction. It is not the case in VAR 3 (three rows within one

stripe), where the direction of the association is opposite to other variants. The coefficient of determination R^2 explains the most of the variation of SH and RCD in all variants (81-90%), and n:SH and n:RCD in VAR 1 (76%, 62% respectively).

Yield per production area (amount of seedlings per a nursery production unit)

Based on data obtained in this investigation, the calculation of yield of qualified (usable) seedlings per production area of 1m^2 was carried on (Table 6). The calculation is based on participation of seedlings in I and II thickness classes (Table 3), because the RCD had less favorable distribution in quality classes than SH of the seedlings. Grouping of rows into stripes increases yield of qualified seedlings per production area in both variants.

Table 6: Amount of produced seedlings per a nursery production unit. VAR = variant, n = average number of seedlings per row (single row and rows within one stripe).

VAR	n	Total production of seedlings per 1m^2 of production unit	Index	Participation of seedlings of I + II thickness class (%)	Production of qualified seedlings per 1m^2 of production unit	Index
1	26.3	131.5	100.0	50.6	66.5	100.0
3	29.0	280.6	224.1	59.9	168.0	252.6
4	40.7	353.9	282.7	48.1	170.2	255.9

DISCUSSION

Nursery seedlings production should meet two requirements: proper seedling quality and low cost. Therefore investigations on seedling density (meant as quantity, i.e. yield of seedlings per unit production area) and spacing (meant as spatial distribution) have great importance, both of the aspect of target seedling quality and quantity of production (van den Driessche 1982, Duryea 1985, 1984, Mexal and Landis 1990, Dini-Papanastasi et al. 2012). Hardwood species react differently on growing density, but generally smaller densities produce larger and sturdier seedlings (Semerci et al. 2008, Yücedağ and Gailing 2012, Cicek et. al. 2011). According to Ciccarese (2005), for conditions of the northern Mediterranean basin adequate spacing to obtain sturdy plants of broadleaf species with a well-balanced shoot/root ratio is 120 cm^2 per plant, shaped $15 \times 8\text{ cm}$. For *Juglans*, *Quercus*, *Celtis*, *Platanus*, *Acer* and other species spacing ranges from 100 up to 400 cm^2 per plant. Yücedağ and Gailing (2012) investigated effects of spacing on 1+0 seedlings of *Amygdalus communis*, *Prunus avium*, *Pyrus elaeagnifolia* and *Eriolobus trilobatus*, grown in within-row spacing of 4, 8 and 12 cm, in rows 20 cm apart. The highest values for RCD, SH, tap root length and number of fine roots was detected for lowest density (41 seedlings/m^2) in *A. communis* and *P. avium*, but not in *P. elaeagnifolia* and *E. trilobatus*.

In our investigation, seedlings growing in single rows (VAR 1) use c/a 80 cm^2 each, spaced approximately $4 \times 20\text{ cm}$. Seedlings in VAR 3 and VAR 4, however, grow in more

severe competition, where seedlings occupying the inner part of the stripe use limited space of 10-12 cm² each. Seedlings growing on the outer edges use partly the wider inter-stripe space. Such density and spacing resulted in differences in seedlings quality.

According to Rédei et al. (2008), in Hungary there are produced black locust seedlings 40-90 cm high and 5-12 mm thick. Semerci et al. (2008) reports that Turkish Standards Institution requires for 1+0 black locust seedlings of I/II class: SH min. 50/30 cm, RCD 7/4 mm respectively. These quality demands are far stricter than Macedonian standards (MKS), especially in the term of RCD. In our investigation, c/a 85-95% of black locust seedlings meet the height standards of MKS (I/II class: min. 40/25 cm), but only c/a 50-60% meet the standards in terms of RCD (I/II class: min. 4/3mm). This is expressed the most in VAR 4, i.e. increasing seedling density decreases the RCD and increases the cull.

Our investigation on relations between seedling traits reveal strong correlation between SH and RCD, while RCD:FOLR has medium correlation. Seedling density (here as average number of seedlings per row) in relation to SH, RCD and FOLR has moderate - strong *R*. However, in the case of VAR 3 these coefficients are weak-moderate and show unexpected – opposite direction. We couldn't find explanation for this. Mexal and Landis (1990) state that relationship between heights or diameter and other morphological traits are often confounded by cultural practices employed to attain the target SH or RCD. They conclude that SH is frequently highly correlated with RCD, but it is often weakly correlated with other parameters such as total seedling weight, root:shoot ratio or root morphology. On the other hand, RCD is related to root characteristics including root weight and root morphology. In terms of FOLR, Jacobs and Seifert (2004) has investigated ability of the number of FOLR to predict field performance in black cherry, white oak and northern red oak in relation to other morphological traits (SH, RCD, root volume and whole plant fresh weight). They concluded that FOLR tend to be among the least effective predictors of total height and diameter one year after the planting. They found that although FOLR is correlated with root system size, the root volume provides a more accurate measure for predicting hardwood seedling outplanting success, because it better captures the discrepancy between small vs. large diameter roots, short vs. long lateral roots, and few vs. many second- and third-order lateral roots. Stjepanović and Ivetić (2013) also conclude that big root system mass is not always an indicator of the roots fibrosity. Thompson and Schultz (1995) investigated performance of 1+0 northern red oak (*Quercus rubra* L.) seedlings 3 years after outplanting. They concluded that survival, height growth and diameter growth were significantly greater in seedlings with 10 or more FOLR than in seedlings with 4 or less FOLR. According to these finds, seedlings of all variants in our study lie on the lower critical line.

In our investigation we calculated the yield per production area of black locust seedlings grown in bigger densities and spaced in stripes. Grouping single rows into stripes increased the yield per unit area both in VAR 3 and VAR 4, by 252.6% and 255.9% respectively. The percent of culling seedlings, comparing to VAR 1, is lower in VAR 3 and higher in VAR 4, therefore in this case it cannot be concluded whether increasing growing density decreases participation of usable seedlings. In this term, Mexal and Landis (1990) state that economics may favor growing seedlings at densitiesthat maximize the yield per unit area, regardless of percentage of culls.

Some investigators were dealing with effects of various nursery densities and spacing on morphological quality of the seedlings in comparison with the growth after planting. Semerci et al. (2008) investigated the effect of spacing on quality of 1+0 *Robinia pseudoacacia* seedlings, grown at four different spacing (3-12 cm) in seedbed and at four spacing within rows (40-100 cm) on experimental field. They assessed survival and growth after 3 years. Seedlings from 3 cm seedbed spacing had smaller SH, RCD and weight than from 6, 9, 12 cm spacing. The same situation was observed on experimental field, i.e. seedlings from 40 cm spacing had smaller SH, RCD and weight than from 60, 80, 100 cm row spacing. Wider spacing produced larger seedlings but seedbed spacing had no significant effects on 1st and 3rd year survival. The yield of usable seedlings of 3 cm seedbed and 40 cm field spacing was the highest. Seedlings produced at 3 cm spacing on seedbed and 40 cm row spacing were shorter about 20 cm at the end of 3rd year of out planting, however they grew faster and the height difference might not remain in the future. They conclude that seedling morphology is not a perfect predictor of field survival. Similar results were reported by Ciceket. al. (2011), for 1+0 bareroot seedlings of *Fraxinus angustifolia* and *Ulmus laevis* grown at different seedbed densities and 4 years after outplanting. *F. angustifolia* was grown with 40-120 and *U. laevis* with 75-175 seedlings per m². Seedlings of both species from lowest seedbed density and trees 4 years after planting had biggest RCD and SH, however, four years after planting there were no significant differences in SH and RCD increment among trees of various densities.

CONCLUSIONS

The traditional way of spacing in single rows, i.e. with lowest seedbed density, produces seedlings with highest values of SH, RCD and FOLR. They have the best morphological traits of the root system. Spacing in stripes of 3 and 4 rows affected some morphological traits of the seedlings, decreasing RCD, FOLR number and root system quality. Grouping 4 rows into a stripe deteriorates the quality structure of produced seedlings, increasing culls. However, morphological quality of seedlings produced in stripes of 3 rows is still satisfactory and quite close to seedlings from single rows. They have the best distribution in thickness classes and provide in the same time about 2.5 time higher yield from production area. This variant is considered to be acceptable for nursery practice.

REFERENCES

- Алыбеков А.А. (2013). Техника и технология выращивания посадочного материала в лесных питомниках. Экология и лесоводство, Вестник Иссыйк-Кульского университета, № 36, 2013. pp. 63-66.
- Anonymous (1968). MKS D.Z2.112, 1968. Forest seedlings – Broadleaf species.
- Anonymous (2012). Наредба № 4 от 15 февруари 2012 г. за условията и реда за регистрация на горски разсадници, както и за производство на фиданки в горските разсадници - държавна собственост. Издадена от Министерството на земеделието и храните, Обн. ДВ.бр.17 от 28 Февруари 2012 г.

PROCEEDINGS
International Conference **REFORESTATION CHALLENGES**
03-06 June 2015, Belgrade, Serbia

- Байтулин И.О. (2009). Создание лесного питомника и технология выращивания посадочного материала. - Костанай: Костанайполиграфия, 2009. 48 с.
- Ciccarese L. (2005). Challenges and Successes in Regeneration Practices in the Northern Mediterranean Basin. Proceedings of the Thin Green Line: A Symposium on the State-of-the Art in Reforestation. Forest Research Information Paper 160. p. 2-10.
- Cicek E., Cicek N., Tilki F. (2011). Four-year Field Performance of *Fraxinus angustifolia* Vahl. and *Ulmus laevis* Pall. Seedlings Grown at Different Nursery Seedbed Densities. Research Journal of Forestry, 5: 89-98.
- Dini-Papanastasi O., Kostopoulou P., Radoglou K. (2012). Effects of seed origin, growing medium and mini-plug density on early growth and quality of black locust (*Robinia pseudoacacia* L.) seedlings. Journal of Forest Science, 58, 2012 (1): 8–20.
- Duryea M.L. (1985). Proceedings: Evaluating seedling quality: principles, procedures, and predictive abilities of major tests. Workshop held October 16-18, 1984. Forest Research Laboratory, Oregon State University, Corvallis. ISBN 0-87437-000-0
- Dušek V. (1997). Lesní školkařství, Základní údaje. Maticesnická, pp. 138.
- Илиев Н., Милев М., Александров П., Петкова К. (2014). Производство на фиданкиот дървесни и храстови видове. Издателска къща при Лесотехническият университет, Интелентранс ООД, София. ISBN 978-954-332-127-8. с. 333
- Jacobs D.F., Seifert J.R. (2004). Re-evaluating the significance of the first-order lateral root grading criterion for hardwood seedlings. Proceedings of a 14th Central Hardwood Forest Conference held at the Ohio Agriculture Research and Development Center (OARDC), The Ohio State University, Wooster, Ohio March 16-19, 2004. 382-389.
- Jacobs D.F., Salifu K.F., Seifert J.R. (2005). Relative contribution of initial root and shoot morphology in predicting field performance of hardwood seedlings. New Forests 30:235–251.
- Kolevska D.D., Velkovski N. (2009). Occurrence of black locust (*Robinia pseudoacacia* L.) offspring after a forest fire. In Macedonian. Forest Review, Vol. XLII 163-170.
- Kolevska D.D. (2005). Representation of exotic species in forest nurseries and afforestation in the Republic of Macedonia and protection of biodiversity. In Macedonian. 1st Congress of plant protection “Environmental concern and food safety. Ohrid 28.11.-2.12.2005. Proceeding of articles, 177-181.
- Kolevska D.D., Acevski J. (2005). Expansion of some allochthonous trees and bushes into urban and forest ecosystems in the Republic of Macedonia. In Macedonian. 1st Congress of plant protection “Environmental concern and food safety. Ohrid 28.11.-2.12.2005. Proceeding of articles, 181-184.
- Kostopoulou P., Radoglou L., Dini Papanastasi O., Adamidou C. (2011). Effect of mini-plug container depth on root and shoot growth of four forest tree species during early developmental stages. Turk J Agric For. 35 (2011) 379-390
- Mantovani D., Veste M., Freese D. (2014). Black locust (*Robinia pseudoacacia* L.) ecophysiological and morphological adaptations to drought and their consequence on biomass production and water-use efficiency. New Zealand Journal of Forestry Science 2014, 44:29, on line version.
- Mexal J.G., Landis T.D. (1990). Target seedling concept: Height and Diameter. In: Rose R., Cambell S.J., Landis T.D. (eds.) Proceedings of the combined meeting of the Western Forest Nursery Associations; 1990 August 13-17; Roseburg, OR. Gen. Tech. Rep. RM-200. Fort Collins, CO: US Department of Agriculture, Forest Service, Rocky Mountain Forest and Range Experiment Station. 17-35.
- Rédei K., Osváth-Bujtás Z., Veperdi I. (2008). Black locust (*Robinia pseudoacacia* L.) Improvement in Hungary: a Review. Acta Silv. Lign. Hung., Vol. 4 (2008) 127-132.

PROCEEDINGS
International Conference **REFORESTATION CHALLENGES**
03-06 June 2015, Belgrade, Serbia

- Semerci A., Güner T., Çömez A., Çelik N., Karataş R., Koraye. E., Genç M., Tuncer E., Güner T. (2008). The effects of seedbed density on some morphological and physiological properties and field performance in black locust (*Robinia pseudoacacia* L.) seedlings: A case study from Eskiflehir Central Anatolia Forestry Research Institute, Technical Bulletin No: 285, p. 33.
- Sloan J. P. (1990). Comparison of the Summit Precision Seeder with the Oyjord Seeder. Target seedling symposium: Proceedings, Combined Meeting of the Western Forest Nursery Associations. Roseburg. 167-173
- Stamenkov M., Kolevska D. (2000). Dependence between the length of the hydrothermal treatment and the germination of the black locust (*Robinia pseudoacacia* L.) of different origin. In Macedonian. Jubilee Yearbook of the Faculty of Forestry, University of "St. Cyril and Methody" – Skopje. 80-90.
- Stjepanović S., Ivetić V. (2013). Morphological indicators of the quality of one-year-old bare-root seedlings of wild cherry (*Prunus avium* L.). Bulletin of the Faculty of Forestry 107: 205-216.
- Thompson J.R., Schultz R.C. (1995). Root system morphology of *Quercus rubra* L. planting stock and 3-year field performance in Iowa. New Forests 9: 225–236.
- Trendafilov A., Rizovska Atanasovska J., Trendafilov B. (2009). Preliminary research on the process of biological reclamation of the slag disposal site "Kale" at the ferronickel smeltery "Feni Industries"—Kavadarci. International Conference: Land Conservation - Landcon 0905, WASWC, Tara Mountain, Serbia, 26-30 May, 2009.
- van den Driessche R. (1982). Relationship between spacing and nitrogen fertilization of seedling in the nursery, seedling size, and outplanting performance. Can. J. For. Res. 12:865-875.
- van den Driessche R. (1984). Seedling spacing in the nursery in relation to growth, yield, and performance of stock. For. Chron. 60:345-356.
- Yücedağ C., Gailing O. (2012). Effects of Seedbed Density on Seedling Morphological Characteristics of four Broadleaf Species. Instituto Nacional de Investigación y Tecnología Agraria y Alimentaria (INIA). Forest Systems 21(2), 218-222.

MASS CLONAL PROPAGATION OF ELMS AS WAY FOR REPLACEMENT OF ENDANGERED AUTOCHTHONOUS SPECIES

Grbić Mihailo, Skočajić Dragana, Đukić Matilda, Đunisijević-Bojović Danijela, Marković Marija

*Corresponding author: mihailo.grbic@sfb.bg.ac.rs

Grbić M., Skočajić D., Đukić M., Đunisijević-Bojović D., Marković M. (2015). Mass clonal propagation of elms as way for replacement of endangered autochthonous species. In: Ivetić V., Stanković D. (eds.) Proceedings: International conference Reforestation Challenges. 03-06 June 2015, Belgrade, Serbia. *Reforesta*. pp. 60-67.

Abstract: Due to increasing use of interspecies and allochthonous (mainly Asiatic) taxa of elms, caused by Dutch elm disease (DED), the study of the most suitable methods of *in vitro* propagation has been imposed. DED is, in itself, a product of changed environment which was a trigger for virulence of fungus (*Ophiostoma ulmi* (Buisson) Melin & Nannf. (1934)). *Ophiostoma* devastated elms throughout Europe and much of North America in the second half of the 20th century.

Lack of elms in Serbia, have been generally compensated by introduction of Siberian elm (*Ulmus pumila* L.) and its application in shelter belts. Recent investigations, however, show its invasive nature in Serbia. In Europe and the United States the problem has been rectified by use of resistant elm cultivars synthesized, as only correct solution. Advocating for such a solution, a series of experiments performed with explants of six elm taxa: *Ulmus 'Dodoens'*, *Ulmus 'Lobel'*, *U. glabra 'Exoniensis'*, *U. carpinifolia*, *U. chenmoui* and *U. pumila*, in two growing media Murashige and Skoog, and Woody plant. Concentration of auxin and cytokinin was also altered.

For all six taxa were found optimal medium that allows fast and efficient production of identical copies that unite resistance to the pathogen and broad ecological range, guarantees for survival in altered environments. The applied methods can produce more than 1,000,000 identical virus free copies in less than a year, in each variant.

Keywords: elm, elm cultivars, *in vitro* propagation, nursery stock for altered environments.

INTRODUCTION

With the appearance of “Dutch elm disease” in 1919th in Belgium, elms, formerly a regular companions in the oak and beech forests, gradually disappear, depriving forestry of valuable economic and ameliorative species belonging to this genus. For the same reason landscape architecture has been a bridge in used elm in urban environments and country areas advancement.

Aggressiveness and high virulence of the pathogen and its adaptability and changeability are undisputed. The most important changes are related to the pathogen

from spreading to the west and east. The first change is related to the spread of the disease in North America, where the infection is transferred with the timbers for ships building in year 1929. Changed environment has led to more virulent forms of whose origin nothing is known, but certainly a poligenic aggression that can not be explained by a simple mutation of less aggressive in more aggressive strain. This strain was transferred from Canada to Europe by elm logs in 1960. Its disastrous effects manifest especially in England where 2/3 of 24 million English elms were exterminate (Heybroek et al. 1982). This strain of the pathogen, known as the "Western", attack resistant clones reduced their use to a minimum.

Around 1980 from the Soviet Union to Europe passed a form known as the "East strain", which also makes by its virulence several previously resistant clones unusable or less usable. During more than six decades implemented a series of clones of him more or less united the two required properties: resistance and the appropriate size and habit. In this leading researchers come from the Netherlands, the United States and Canada.

In 1973 appears the third generation of the various European male parents and the same female (*U. wallichiana* x *U. glabra* 'Exoniensis') with a relatively high resistance to aggressive strains. Two of three clones of this generation (*U. 'Dodoens'* *U. 'Lobel'* and *U. 'Plantyn'*) are included in this study and details about them will be presented further on. In the U.S. there are several centers where work on the synthesis of resistant elm clones: University of Wisconsin, Madison (with clones of *U. 'Regal'*, *U. 'Sapporo Autumn Gold'* and *U. 'American Liberty'*), Morton Arboretum (*U. 'Accolade'* and *U. 'Denada'*), USDA Nursery Crops Laboratory, Delaware - Ohio (*U. 'Urban'*, *U. 'Homestead'* and *U. 'Pioneer'*), Oklahoma State University, Stillwater (*U. 'Prairie Shade'*), etc. Canadian clones *U. 'Jacan'*, *U. 'Thomson'* and *U. 'Mitsui Centennial'* also show a high degree of resistance to the Dutch elm disease.

The situation in Serbia in terms of overcoming the elm decline, judging by the lack of published works in this area, is characterized by extreme inactivity. In our country, the Dutch elm disease was detected in 1943 when recorded significant dieback of trees with breast diameter of over 80 cm, in the Srem forest, towards Belgrade. At the same time the mass dieback of elm was recorded in Banat, near to the Romanian border. Since the outbreak until now no specific regulations related to its prevention and control of its vectors are not in place, apart from sporadic measures to protect trees from bark beetle hunting and cutting off the infected branches.

Works on the selection of resistant individuals were stopped in their first stage of determination (without checking the resistance of artificial inoculation). Work on the introduction of foreign-resistant clones or resistant species consists mainly of Asian highly resistant *U. pumila* L. with which there was no attempt of controlled crosses with indigenous species, and production in the nurseries at the species level, generative, seeds of local provenance (Grbić 1981).

Siberian elm is a spontaneously introduced species in Serbia in the middle of 20 century as a very efficient replacement for European field elms. The aim was to use it in urban and rural landscapes and also in the process of hybridisation for resistant clones. It is widely recommended for southern Europe and dry areas and it has very good adaptation and is spread on a great range. In the meantime, *U. pumila* showed a high

degree of invasiveness, and its further use is questioned. Previously undertaken studies clearly indicate that.

In that studies seed was gathered from one of the primary introduced population of Siberian elm, 20 years old, and used to produce plants. Seven one year old seedlings were selected and planted on green area between residential buildings in the locality Banovo Brdo, Belgrade. Green areas in the vicinity, mostly green spaces between residential buildings, was the ideal place for self sowing of this species. These trees begun to fructificate after 6 years. The outspreading of Siberian elm seedlings from seven trees planted 1982 in Belgrade area locality - Banovo Brdo, was observed. During the several decades a great number of trees sprout from seed and many of them became fertile and gave a contribution to further speeding of this invasive species. During next 20 years those trees had spread spontaneously in the radius of about 300 m. It was found over 400 trees of various heights and about one third became fertile.

Besides generative reproduction this invasive plant species has an enormous potential to vegetative reproduction. A great number (40-50) individuals developed from suckers were discovered during our investigation (Grbić et al. 2007, 2008).

As the empty field elms niches can invade this neophyte, and threat biodiversity by abundant diaspora, it would be limited to the indirect use as resistant parents to Dutch elm disease for crosses with domestic species. In this way, would be created resistant hybrids - an alternative to invasive elm.

Classical methods of reproduction, which have been developed over a long period before the onset epiphytotic disease, are generally unsuitable for the mass propagation of resistant cultivars. Heterovegetative methods are not suitable because in addition to general shortcomings (low productivity, complexity of implementation, the need for trained personnel) an exhibit of resistant clones particularly important: the possibility of influence often non-resistant understock on the general resistance of ramets. The low level of multiplication of the grafting, as well as layering (both classical methods) is also characteristic which made almost completely those methods unuseful.

The aim of investigation was to examine the possibility of *in vitro* mass propagation some of elm taxa: two Dutch-resistant clones (*Ulmus* 'Dodoens', *Ulmus* 'Lobel'), an ornamental (*U. glabra* 'Exoniensis') and three prospective parents for hybridization (*U. carpinifolia*, *U. chenmoui* and *U. pumila*).

MATERIAL AND METHODS

Among many clones resistant to Dutch elm disease there are two with high level of survival, which have been realized in Wageningen, Netherlands, and which were used for this trial. The seed from which has emerged 'Dodoens' clone was collected in 1954 from clone 202 (*U. glabra* 'Exoniensis' x *U. wallichiana* P39) developed in the process of free pollination, and some of its features suggest a possible self-fertilization. Seedlings that received the label 494 have proven to be superior and are classified in the "third generation" of Dutch clones. A clone is involved in field experiments from 1967/68, with 16 ramets only. His habit, depending on environmental conditions, can vary widely, although orteta is strong and robust tree. Cultivar was registered in 1973, under the name

U. 'Dodoens' after Rembert Dodoens (1516-1585) a famous doctor, botanist and professor at Leiden University.

Cultivar '*Lobel*' was obtained by crossing the 202 x 336 clones in 1954. Of all the progeny was selected one individual with satisfactory properties, CV 454. Maternal plant, clone 202, is a hybrid obtained in 1938 by crossing *U. glabra* '*Exoniensis*' x *U. wallichiana* P39. This narrow vase-shaped clone, with beautiful dark leaves that late fall, had moderate resistance to Dutch elm disease. Male parent, clone 336, was obtained from self-pollinated *U. x hollandica* '*Bea Schwarz*'. *Ulmus* '*Lobel*' was registered in 1973 in honor of Mathias de l'Obel's (1538-1616) scientists in the field of medical science, personal physician of Willem van Oranje and botanist after whom the genus *Lobelia* L. (*Campanulaceae*) is named.

Propagules provenance of both clones was the Collection of the Institute for Forestry and Landscape Architecture, "De Dorschkamp" Wageningen. The age of seedlings obtained from green cuttings was two years. *U. glabra* '*Exoniensis*', *U. carpinifolia*, and *U. pumila* are well-known species often used in hybrid synthesis.

Ulmus chenmoui Cheng is a species from Far East that was unknown in Europe until 1979, when the seeds were sent from Beijing to the "Dorschkamp"-Wageningen, the European Centre for Breeding Elms. Although the tree can grow to a height of up to 20 m, the slender trunk rarely exceeds 0.5 m d.b.h.; the bark exfoliates in irregular flakes. The wingless twigs bear comparatively large obovate to oblong leaves up to 18 cm in length, with doubly serrate margins and caudate to acuminate apices. The perfect wind-pollinated apetalous flowers are produced on second-year shoots in March; the samarae are obovate, 25 mm long by 17 mm wide and ripen in April (Fu et al. 2002). *U. chenmoui* has a very high resistance to Dutch elm disease (Heybroek 1981).

Material for explants was taken from the Institute for Forestry and Landscape Architecture, "De Dorschkamp" Wageningen (Netherlands). IN VITRO propagation was carried out with meristems explanted from the axillary buds. Murashige & Skoog and Woody plant growing media were used, with varying concentrations of cytokinins and auxins. Phytohormones that used were benzyladenine (from the group of cytokinin), and Indole-3-butyric acid (as auxin). Concentrations were 0.05 mg·L⁻¹ and 0.1 mg·L⁻¹ respectively. Phytohormones were added separately or both of them. Agar concentration was 7g·L⁻¹, and content of sucrose was 20 g·L⁻¹. Plant material - short one node cutting without leaf has been prepared and sterilized by dipping in 70% ethanol for 5 sec. After that the material was placed in container with 1.5% sodium hypochlorite solution. The container was covered and the material mixed for 20 minutes on the magnetic stirrer. The washing out of sodium hypochlorite was done by distilled and sterilized water, first time 1 minute, and then three times of 10 minutes. Explants were incubated in test tubes containing 20 ml of the medium. Before autoclaving pH of medium was adjusted to 5.8. Sterilization of the medium was carried out at 115°C and 1.5 atm for 20 minutes.

The explants were incubated at the unchanged temperature of 24-25°C, and under fluorescent light at light intensity of 3,500 lx, photoperiod prolonged to 16 hrs. The development of shoots was estimated after four weeks on the base of the number of axillary buds which was available for the subculture (Grbić 1993, 1994). Obtained results

were analyzed by "STATGRAPHICS Plus" and interpreted by analysis of variance (Anova table and multiple range tests).

RESULTS AND DISCUSSION

Based on the analysis of variance and multiple range analysis for the number of developed buds (Table 1) in two different media with different concentrations of phytohormones, in all tested species and intraspecific and interspecific hybrids, we can say that the WPM more suitable than M&S medium. WPM supplemented with one of hormones (cytokinin for *U. carpinifolia* and auxin for others) proved to be more efficient than combination of hormones applied. The development of buds in the M&S medium, regardless to the combination of certain phytohormones is weaker. M&S with auxin (M&S+0.1 IBA) for all elms are singled out as the worst (the lowest value obtained for the average number of buds were isolated in separate homogeneous group), although other combinations of hormones in the M&S medium concerning statistical significance can not be singled out as better, except *U. carpinifolia* (M&S+0.05BA and M&S +0.05 BA/0.1IBA) and *U. 'Lobel'* (M&S+0.05BA /0.1IBA). In other words for all elms taxa, except the two mentioned, can be concluded that M&S medium with tried combinations of phytohormones unsuitable for the development of buds.

Table 1. Basic statistical parameters for the number of buds in the M&S and WP media (M±SE)

	<i>U. carpinifolia</i>	<i>U. chenmoui</i>	<i>U. 'Dodoens'</i>	<i>U. glabra 'Exoniensis'</i>	<i>U. 'Lobel'</i>	<i>U. pumila</i>
M&S+0.05BA	3.17 ^b ±0.46	2.5 ^{bcd} ±0.67	2.7 ^{bcd} ±0.65	2.1 ^c ±0.58	2.62 ^{bc} ±0.62	2.9 ^{ab} ±0.75
M&S+0.1IBA	1.13 ^c ±0.43	1.27 ^d ±0.42	1.58 ^e ±0.5	2.91 ^c ±0.65	1.09 ^c ±0.56	1.5 ^b ±0.57
M&S+0.05BA/0.1IBA	3.33 ^b ±0.33	2.33 ^{cd} ±0.33	2.67 ^{cde} ±0.84	1.46 ^c ±0.54	4.5 ^{ab} ±0.19	3.17 ^{ab} ±0.48
WPM+0.05BA	5.47 ^a ±0.40	3.44 ^{abcd} ±0.47	4.67 ^{abcd} ±0.25	4.87 ^{ab} ±0.32	4.4 ^{ab} ±0.32	3.28 ^{ab} ±0.28
WPM+0.1IBA	2.17 ^{bc} ±0.38	5.07 ^a ±0.42	5.33 ^a ±0.77	5.53 ^a ±0.44	4.93 ^a ±0.78	5.14 ^a ±0.56
WPM+0.05BA/0.1IBA	1.14 ^{bc} ±0.74	3.73 ^{abc} ±0.71	2.5 ^{de} ±0.7	3.28 ^{bc} ±0.47	2.11 ^{bc} ±0.45	2.9 ^{ab} ±0.58

According to the statistical parameters this difference is most clearly observed in *U. glabra 'Exoniensis'* - all values concerning M&S medium were belonged to same homogeneous group. In comparison to WPM medium statistically significant difference does not occur only in relation to WPM +0.05 BA / IBA 0.1.

Statistical analysis of the number of roots formed (Table 2) for all taxa: three species and three cultivars of elms, in investigated media (WPM and M&S) and combinations of hormones (BA and IBA), pointed out there was no significant difference, except for *U. 'Dodoens'* and *U. pumila*. Number of formed roots in *U. 'Dodoens'* which was developed in WPM medium was significantly larger than number of roots from M&S+0.05 BA medium, WPM with auxin, and a combination of both (WPM +0.05 BA/IBA 0.1). Same parameter compared for all variants of M&S medium (M&S+0.05BA, M&S+0.1IBA, M&S+0.05BA/0.1IBA) show no significant differences between treatments, and IBA +0.1 M & S +0.05 BA / IBA 0.1 is a significant difference level. For *U. pumila* homogenous groups suggests a different reaction of this species to presence of single or combination of phytohormones in the media. The greatest number of roots of Siberian elm plantlets was

formed in the M&S +0.1 IBA and this value is significantly different from the results obtained on WPM +0.05 BA/IBA 0.1, only. All other combinations of media and phytohormones with the appearance of a single overlap between groups indicate that differences are not statistically significant.

Table 2. Basic statistical parameters for the number of formed roots in the M&S and WP media (M±SE)

	<i>U. carpinifolia</i>	<i>U. chenmoui</i>	<i>U. 'Dodoens'</i>	<i>U. glabra 'Exoniensis'</i>	<i>U. 'Lobel'</i>	<i>U. pumila</i>
M&S+0.05BA	1.08 ^{ns} ±0.36	0.42 ^{ns} ±0.23	0.1 ^b ±0.1	0 ^{ns} ±0	0.46 ^{ns} ±0.18	0.5 ^{ab} ±0.34
M&S+0.1IBA	1.07 ^{ns} ±0.40	0.53 ^{ns} ±0.27	0.58 ^{ab} ±0.23	0.54 ^{ns} ±0.28	1.18 ^{ns} ±0.54	1.21 ^a ±0.33
M&S+0.05BA/0.1IBA	0.17 ^{ns} ±0.17	0 ^{ns} ±0	1.5 ^{ab} ±0.85	0.92 ^{ns} ±0.43	0.5 ^{ns} ±0.27	0.17 ^{ab} ±0.17
WPM+0.05BA	1.07 ^{ns} ±0.42	0 ^{ns} ±0	2.27 ^a ±0.64	0.93 ^{ns} ±0.36	0.6 ^{ns} ±0.25	0.57 ^{ab} ±0.3
WPM+0.1IBA	0 ^{ns} ±0	0.73 ^{ns} ±0.27	0.5 ^b ±0.34	1.07 ^{ns} ±0.42	1 ^{ns} ±0.5	0.64 ^{ab} ±0.2
WPM+0.05BA/0.1IBA	0 ^{ns} ±0	0 ^{ns} ±0	0.4 ^b ±0.4	0.71 ^{ns} ±0.56	0 ^{ns} ±0	0.1 ^b ±0.1

The intensity of callus formation among most of the tested elms may be associated with the presence of auxin in the media (Table 3). In all taxa, the WPM with auxin provoked the highest values and the occurrence of overlapping homogeneous groups with M&S with auxin also occurs in most (*U. glabra 'Exoniensis'* and *U. 'Dodoens'* were exception). The combination of auxin and cytokinin in both media show a high degree of homogeneity with media containing auxin only in intensity of kalus proliferation (only *U. chenmoui*, *U. 'Dodoens'* and *U. 'Lobel'* mark significantly weaker results).

Concerning *U. carpinifolia* media M&S and WPM with auxin, as well as WPM with cytokinin and auxin are separated into distinct homogeneous group. The mean values obtained in these media are significantly different only from M&S +0.05 BA. With other media, the occurrence of overlapping homogeneous groups indicating weaker significance of differences. For *U. chenmoui* auxin in WPM induces the callus formation, which is significantly different in quantity from the callus formed on WPM+0.05BA and M&S+0.05BA/0.1IBA. With other combinations of cytokinins and auxins in the WPM and M&S the significance decreases. The values of the intensity of callus formed by *U. 'Dodoens'* in WPM with auxin overlaps only with the values of M&S +0.05 BA / IBA 0.1. In relation to the others difference is statistically significant.

The emergence of a number of multiple overlapping homogenous groups with values obtained for the *U. glabra 'Exoniensis'* suggests less significant differences obtained. Statistically significant differences were noticed between the WPM +0.1 IBA, WPM +0.05 BA, WPM +0.1 IBA, and M&S +0.1 IBA. In *U. 'Lobel'* and *U. pumila* auxins in both media gave the best results compared to other taxa. Significantly lower results in *U. 'Lobel'* were recorded on both media with cytokinins as well as M&S +0.05 BA/0.1IBA, and at *U. pumila* only in WPM +0.05 BA.

Table 3. Basic statistical indicators for the intensity of callus formation in M&S and WP media (M±SE)

	<i>U. carpinifolia</i>	<i>U. chenmoui</i>	<i>U. 'Dodoens'</i>	<i>U. glabra 'Exoniensis'</i>	<i>U. 'Lobel'</i>	<i>U. pumila</i>
M&S+0.05BA	0.58 ^b ±0.14	1 ^{abc} ±0.35	1.1 ^b ±0.38	1.6 ^{abc} ±0.48	0.69 ^{bc} ±0.41	1.5 ^{ab} ±0.37
M&S+0.1IBA	2.2 ^a ±0.34	1.47 ^{abc} ±0.42	1.17 ^b ±0.38	1.09 ^{bc} ±0.25	2.45 ^a ±0.43	2.14 ^a ±0.4
M&S+0.05BA/0.1IBA	1 ^{ab} ±0.52	0 ^c ±0	2 ^{ab} ±0.36	2.38 ^{ab} ±0.46	0 ^c ±0	1.33 ^{ab} ±0.49
WPM+0.05BA	1.6 ^{ab} ±0.16	0.56 ^{bc} ±0.16	1.4 ^b ±0.16	0.93 ^c ±0.15	0.67 ^{bc} ±0.19	0.43 ^b ±0.2
WPM+0.1IBA	2.5 ^a ±0.42	2.13 ^a ±0.16	2.58 ^a ±0.19	2.67 ^a ±0.19	2.73 ^a ±0.28	2.21 ^a ±0.21
WPM+0.05BA/0.1IBA	2.28 ^a ±0.36	1.73 ^{abc} ±0.51	1.3 ^b ±0.45	1.86 ^{abc} ±0.67	1.78 ^{ab} ±0.55	1.7 ^{ab} ±0.5

CONCLUSIONS

From analyzed indicators of used variants of micropropagation mostly influenced was the number of buds capable for subculture. This number directly affect multiplicative factor, i.e. the potential number of plants that can be obtained after the multiplication phase. Highest average number of buds was obtained with the *U. glabra 'Exoniensis'* and it is 5.53. In other taxa is slightly smaller, but in all cases are greater than 5, except for *U. 'Lobel'* with whom he formed an average of 4.93 buds per plantlet. The results have been achieved on WPM medium supplemented with IBA (BA at *U. carpinifolia*). Since these results were achieved for 4 weeks, it can be assumed that in this medium can be obtained about a year, with 10 subcultures, 10,000,000 plantlets, even in the case of *U. 'Lobel'*.

Different explants reactions in regard to auxin and cytokinin may be explained by varying the concentration of endogenous phytohormones in the bud meristem of various taxa and speed of their uptake (Biondi et al. 1984). For shoot development from buds, as is known, is not crucial presence of cytokinin only, but the relationship of auxin and cytokinin (high BA and low IBA), this correlation was discovered in the mid-twentieth century (Skoog and Miller 1957).

Callus formation is also indicating the ability to propagate elms by more sophisticated micropropagation methods such as cell suspension and protoplast culture. The correlation between the concentration of auxin and callus formation generally was manifested in investigation undertaken regardless of the basic medium (WPM or M&S). As this study was no aimed to obtain callus tissue, for this purpose increased auxin content in the medium and type of explants forming plenty of callus (petiole for example) will be used.

The studies have preliminary character as part of preparations for more extensive work on the selection of suitable elm taxa to replace the missing field elm in altered environmental conditions, with simultaneous alert of invasive species that threaten biodiversity.

Acknowledgment: The paper was realized as a part of the project "Studying climate change and its influence on the environment: impacts, adaptation, and mitigation" (43007) financed by the Ministry of Education and Science of the Republic of Serbia within the framework of integrated and interdisciplinary research for the period 2011-2014.

REFERENCES

- Biondi S., Canciani L., Bagni N. (1984). Uptake and translocation of benzyladenine by elm shoots cultured in vitro. *Can. J. Bot.* 62: 2385–2390.
- Fu L., Xin Y., Whittemore A. (2002). *Ulmaceae*, in Wu, Z. & Raven, P. (eds.) *Flora of China*, Vol. 5 (*Ulmaceae* through *Basellaceae*). Science Press, Beijing, and Missouri Botanical Garden Press, St. Louis, USA.
- Grbić M. (1981). Istraživanje populacija sibirskog bresta (*Ulmus pumila* L.) na Novom Beogradu sa aspekta njihove vrednosti kao izvora semenskog materijala. Magistarski rad. Šumarski fakultet. Beograd.
- Grbić M. (1988). Razmnožavanje otpornih holandskih klonova bresta (*Ulmus 'Lobel' i U. 'Dodoens'*) reznicama i mogućnost njihove introdukcije. *Glasnik Šumarskog fakulteta* 70. Beograd: 115-24.
- Grbić M. (1992): Unapređenje rasadničke proizvodnje nekih brestova (*Ulmus L.*) autovegetativnim metodama razmnožavanja. Doktorska disertacija Šumarski fakultet Beograd.
- Grbić M. (1993): Uticaj "M&S" i "Woody plant" medijuma na razvoj eksplanata brestova. X simpozijum Jugoslovenskog društva za fiziologiju biljaka, Zemun-Polje, Beograd, Knjiga apstrakta 56.
- Grbić M. (1994). Different propagation methods of two resistant elm clones (*Ulmus 'Regal'* and *Ulmus 'Sapporo Autumn Gold'*). International Plant Propagators Society in Bulgaria. Scientific conference "Propagation of ornamental plants". Sofia, Bulgaria: 96-100.
- Grbić, M., Djukić, M., Skočajić, D., & Djunisijević-Bojović, D. (2007): *Role of invasive plant species in landscapes of Serbia*. 18th International Annual ECLAS Conference „Landscape Assessment – From Theory to Practice: Applications in Planning and Design“ Proceedings, Belgrade: 219-28;
- Grbić M., Djukić M., Skočajić D., Djunisijević-Bojović D., Lakićević, M. (2008): Invasive plant species in urban landscapes. III International symposium of ecologists of the Republic of Montenegro. Book of abstracts, Bijela, Herceg Novi: 145.
- Heybroek H.M. (1981). The Japanese elm species and their value for the Dutch elm breeding programme. Proceedings of the Dutch Elm Disease symposium and workshop, October 5 - 9, Winnipeg, Manitoba, 78 - 90.
- Skoog F., Miller C.O. (1957). Chemical regulation of growth and organ formation in plant tissue cultures in vitro. *Symp. Soc. Exp. Biol.* 11, 118–131.

RELATION BETWEEN MORPHOLOGICAL ATTRIBUTES OF FIVE WILD FRUIT TREE SPECIES SEEDLINGS IN SERBIA

Ćirković-Mitrović Tatjana^{*}, Ivetić Vladan, Vilotić Dragica, Brašanac-Bosanac Ljiljana, Popović Vladan

*Corresponding author: tanjacirk@yahoo.com

Ćirković-Mitrović T., Ivetić V., Vilotić D., Brašanac-Bosanac Lj., Popović V. (2015). Relation between morphological attributes of five wild fruit tree species seedlings in Serbia. In: Ivetić V., Stanković D. (eds.) Proceedings: International conference Reforestation Challenges. 03-06 June 2015, Belgrade, Serbia. Reforesta. pp. 68-77.

Abstract: The aim of this research was to investigate robustness of relation between height and root collar diameter to other morphological attributes of five broadleaved wild fruit species (black walnut, walnut, Turkish hazel, service tree, wild cherry) in different fertilization regimes. Diameter was stronger correlated with most measured seedlings morphological attributes only on black walnut seedlings. For other wild fruit species, walnut, Turkish hazel, service tree and wild cherry, height was stronger correlated to other seedlings morphological attributes except root length and Dickson Quality Index. More interestingly, for all species except for service tree, height was much stronger correlated to root dry weight than diameter, explaining larger portion of variation ($r^2=0.41-0.72$).

Key words: Persian walnut, black walnut, Turkish hazel, service tree, wild cherry, seedlings morphological attributes correlations.

INTRODUCTION

Morphological variables are the most universally measured in seedling quality assessment (Ritchie 1984, Thompson 1985, Mexal and Landis 1990). The most commonly measured morphological attributes are height and diameter (Mattsson 1996, Haase 2008, Ivetić 2013) with seedling diameter considered as the single most useful morphological attribute to measure (Johnson and Cline 1991, Ivetić et al. 2013). These two attributes are more reliable when measured and used combined (Haase 2008, Binotto et al. 2010).

Many studies have evaluated other morphological attributes as root development, dry weights; different ratios as height to diameter, shoot to root and more complex index as Dickson Quality Index (reviewed by Ritchie 1984, Thompson 1985, Mexal and Landis 1990, Mattsson 1996, Grossnickle 2012, Ivetić 2013). However, not all of morphological attributes are practical to implement at operational scale (Jacobs et al. 2004). This is why knowledge on relation between non-destructive and easily measured to destructive and time demanding to measure attributes is important.

Application of mineral fertilisers in forest production began more than one hundred years ago (Baule and Fricker 1978). Mineral nutrition represents one of the

methods for the improvement of the quality of the produced seedlings at the nurseries, because the nutritional status of seedlings in nursery has a direct effect on survival after field planting (Landis et al. 2004). Nutrition of seedlings has also a positive effect on reduction of replanting stress. Regeneration of root system and fertilisation are in positive correlation (Thompson 1982, Van den Driessche 1990, Nordborg et al. 2003, Haase 2006, Ivetić et al. 2013). Application of fertilisers has a positive impact on growth and development of seedlings, and consequently, their quality (Haase, 2008). Apart from the direct effect on morphometric properties of seedlings (parameters still dominant in the assessment of quality), application of fertilisers has a direct impact on status of particular elements, a content of which assumes an increasing importance in assessment of plant quality. Storing of mineral nutrients, such as nitrogen and phosphorus, in seedlings has a considerable effect on survival and development of seedlings in the course of replanting. The balance of nutrients in seedlings is important for optimum post-replanting physiological processes and performance (Landis 1984). Chemical fertilisers are useful for improvement of nutrient content, soil texture, plant tissue and higher yield production (Will et al. 2002). Due to the environmental limitations and decrease of soil fertility in long term and also economic benefit, organic substance is a better alternative (Malakouti and Homaei 2004).

Fertilization as cultural practice in nurseries can effect seedlings physiological status as well as seedling morphology. In general, fertilization in nursery produces taller, heavier seedlings with larger diameter and shoot to root ratio (Duryea 1984). Diameter is more influenced by fertility compared to height, with nitrogen as major determinant of stem diameter and subsequent yield based on calliper (Mexal and Landis 1990).

Forest fruit species have great importance, and their conservation, improvement and sustainable use of the gene pool of natural habitats is in accordance with the general interest of the conservation of biodiversity in Serbia. The economic aspect of the importance of these species is reflected in the quality of timber and use of the wood industry, and the use of fruit in the food and pharmaceutical industry, as a starting material of varieties and hybrids of cultivated fruit trees for obtaining various types of fruits. The aim of this research was to investigate the robustness of height and root collar diameter relation to other morphological attributes of five broadleaved species in different fertilization regimes.

MATERIAL AND METHOD

Correlations between morphological attributes of one-year old seedlings were examined for five wild fruit species: 1) Persian walnut – *Juglans regia* L., 2) black walnut – *Juglans nigra* L., 3) Turkish hazel – *Corylus colurna* L., 4) service tree – *Sorbus domestica* L., and 5) wild cherry – *Prunus avium* L.

Seed collection

The fruits were harvested immediately after maturation at the following locations: black walnut (E 20°25'27", N 44°46'55", 120 m) and Turkish hazel (E 20°25'29",

PROCEEDINGS

International Conference **REFORESTATION CHALLENGES**

03-06 June 2015, Belgrade, Serbia

N 44°46'59", 115 m) in the Arboretum of Faculty of Forestry in Belgrade, Persian walnut (E 22°06'05", N 44°45'34", 520 m) and service tree (E 22°06'23", N 42°51'26" 536 m) in Graovo, near city of Leskovac, and wild cherry (E 21°53'14", N 44°19'31", 532 m) in Debeli Lug, near city of Majdanpek, all in Serbia. Collection of seeds was repeated for three years (2010, 2011 and 2012).

Seedlings production

Bareroot seedlings of five wild fruit species were produced in nursery of the Institute of Forestry in Belgrade (E 20°27'44"; N 44°49'14"; 115 m).

In order to release dormancy, the seeds were stratified on cold-wet regime from November to the end of March next year, at the temperature 3-5 °C. The seeds were sown on April, repeatedly for three consequent years (2011-2013), in five blocks for each species. Each block was consisting of four plots: one control plot and three plots with treatment. Each of plots had three repetitions with 30 seedlings. In order to test a robustness of correlations between seedlings morphological attributes in different fertilization conditions, three fertilizers were applied as treatments: Osmocote® Exact Standard 5-6 M (15+9+12+2MgO+micro-elements), Bactofil® B 10 and Florin 2. The seeds were sown in a pre-prepared substrate with trade name Tref TPS fine brown substrate, produced by TREF Group, Jiffy product international AS, Norway. This substrate of fraction <8 mm and pH 5.8 (±0.3), represents a mixture of peat moss and perlite in a 9:1 ratio (V:V), while peat moss is a mixture containing 70% of white peat moss and 30% of black peat moss.

Osmocote® Exact Standard 5-6 M beside noted macro-elements and Mg consist of 0.45% of total Fe, 0.06% of Mn, 0.020% of Zn, B and Mo and 0.055% of Cu. A 400 g of Osmocote was used per 100 l of substrate. Bactofil is a micro-biological fertiliser containing ten most important soil bacteria: *Azotobacter vinelandii*, *Azospirillum brasilense*, *Azospirillum lipoferum*, *Bacillus megaterium*, *Pseudomonas fluorescens*, *Bacillus subtilis*, *Bacillus polymyxa*, *Bacillus circulans*, *Streptomyces albus*, and *Micrococcus roseus*. Concentration of Bactofil preparation for this research was 0.15 cl/m². Florin 2 NPK 15:15:15, complex NPK mineral fertiliser, contains 15% of nitrogen (6.5% nitrate and 8.5% ammonium) 15% of P₂O₅ (soluble in 2% citric acid and 9% soluble in water) and 15% of K₂O (soluble in water). Florin is applied at a dose of 60 g/m².

The plants were irrigated regularly during growing season, every second day if there was no rain in previous day. Irrigation was performed by sprinkler irrigation system, with water from city water supply system.

Seedlings measurements

After each of three consecutive growing seasons, a sample of 360 seedlings per species (four plots with three repetition, 30 seedlings) which make a total of 1080 seedlings per species in three years, were measured for following seedling morphological attributes (SMA): shoot height (HT), root collar diameter (DIA), root length (RL), shoot dry

PROCEEDINGS

International Conference **REFORESTATION CHALLENGES**

03-06 June 2015, Belgrade, Serbia

weight (SDW), root dry weight (RDW), shoot height/diameter ratio (H/D), and Dickson quality index (DQI).

The HT was measured as the distance between the root collar and the base of terminal bud of dormant seedling, with an accuracy of 0.1 cm. The DIA was measured at or near the root collar, with an accuracy of 0.1 mm. RL was measured on scale as total of all roots. Shoots were separated from roots at the root collar and oven dried in open paper bags for 48 hours, at 80° C. Dry weights were measured on an electronic scale with an accuracy of 0.001 g. The H:D was calculated as ratio between height (in cm) and diameter (in mm). The Dickson quality index (DQI) was calculated (Dickson et al. 1960) from the measure morphological parameters after the first growing season:

$$QI = \frac{\text{seedling dry weight (g)}}{\frac{\text{height (cm)}}{\text{root collar diameter (mm)}} + \frac{\text{shoot dry weight (g)}}{\text{root dry weight (g)}}}$$

Statistical analysis

The relationship between the individual measured and derived morphological characteristics of seedlings was expressed by a simple linear correlation (Pearson R). Coefficient of determination (r^2) was then calculated to examine the proportion of the variance shared by both variables. Pearson coefficient of correlation was calculated on 270 pairs (30 seedlings x three repetitions x 3 years) Correlation and coefficients of determination were calculated in STATISTICA 7 software.

RESULTS

Table 1: Mean values of five wild fruit seedlings morphological attributes (SMA): height (HT), diameter (DIA), root length (RL), shoot dry weight (SDW), root dry weight (RDW), height/diameter (HD), Dickson Quality Index (DQI)

SMA N=1080	black walnut	walnut	Turkish hazel	service tree	wild cherry
HT	46.2	20.9	28.93	30.0	30.4
DIA	6.42	8.06	4.9	5.33	5.13
RL	455	447	159	463	235
SDW	5.75	7.31	2.07	2.65	2.34
RDW	7.61	10.38	2.04	3.76	2.56
H/D	7.34	2.60	5.88	5.67	5.95
DQI	1.70	5.36	0.60	1.01	0.72

There are large differences between species in seedling morphological attributes (Table 1). Black walnut seedlings are tallest with highest height to diameter ratio. Walnut seedlings have the shortest shoot but the largest root collar diameter, resulting with the lowest H/D. Given to the lowest H/D and the largest biomass (SDW and RDW) walnut seedlings have the largest value of DQI. The largest root length was recorded for service

tree, but closely followed by walnuts. Except in height, Turkish hazel seedlings were the smallest.

There is no influence of fertilization on correlation between SMA of black walnut. Height show a stronger relationship with DIA and RL on non fertilized seedlings, but stronger relation to other attributes on seedlings treated with Bactofil and Florin. On the other hand, diameter shows stronger correlations with SMA on seedlings fertilized with Osmocote, and in more instances with Bactofil. Interestingly, SDW shows the stronger correlations with DIA than HT. Further, DQI shows the much stronger correlations with DIA than HT (Table 2).

Table 2: Pearson coefficients of correlations between values of morphological attributes (SMA) of black walnut seedlings (N=270).

SMA	ALL		CONTROL		OSMOCOTE		BACTOFIL		FLORIN	
	HT	DIA	HT	DIA	HT	DIA	HT	DIA	HT	DIA
DIA	0.41**	1.00	0.52**	1.00	0.25**	1.00	0.42**	1.00	0.21**	1.00
RL	0.49**	0.43**	0.57**	0.48**	0.22**	0.56**	0.51**	0.38**	0.46**	0.17**
SDW	0.49**	0.68**	0.46**	0.65**	0.33**	0.67**	0.50**	0.70**	0.42**	0.59**
RDW	0.64**	0.63**	<u>0.63**</u>	0.55**	0.50**	0.62**	0.59**	0.66**	0.64**	0.51**
H/D	0.51**	-0.56**	0.51**	-0.46**	0.54**	<u>-0.66**</u>	0.37**	-0.67**	0.67**	-0.58**
DQI	0.25**	0.86**	0.25**	0.81**	-0.01	<u>0.87**</u>	0.28**	0.88**	0.08	0.84**

Correlation significant at the 0.01 level is marked with **. Correlation significant at the 0.05 level is marked with *.

Table 3: Pearson coefficients of correlations between values of morphological attributes (SMA) of walnut seedlings (N=270).

SMA	ALL		CONTROL		OSMOCOTE		BACTOFIL		FLORIN	
	HT	DIA	HT	DIA	HT	DIA	HT	DIA	HT	DIA
DIA	0.40**	1.00	0.61**	1.00	0.25**	1.00	0.57**	1.00	0.67**	1.00
RL	0.33**	0.40**	0.52**	0.38**	0.48**	0.42**	0.48**	0.42**	0.41**	0.35**
SDW	0.66**	0.44**	0.53**	0.34**	0.71**	0.48**	0.61**	0.61**	0.56**	0.42**
RDW	0.69**	0.57**	0.68**	0.51**	0.75**	0.51**	<u>0.78**</u>	0.67**	0.79**	0.62**
H/D	0.80**	-0.21**	0.60**	-0.26**	0.78**	-0.37**	0.68**	-0.20**	0.71**	-0.04
DQI	0.12**	0.77**	0.37**	0.69**	0.08	0.86**	0.38**	0.83**	0.43**	0.72**

Correlation significant at the 0.01 level is marked with **. Correlation significant at the 0.05 level is marked with *.

Correlations between SMA of walnut are generally weaker in control. Height shows stronger correlations to other SMA compared to diameter, except with DQI which is stronger related to DIA (Table 3).

There was no influence of fertilization on correlation between SMA for Turkish hazel. Height shows a stronger correlation to H/D ratio and diameter shows a stronger correlation to DQI (Table 4).

There was no influence of fertilization on correlation between SMA for service tree. Height show a stronger relationship with DIA and RL on seedlings treated with Florin. But stronger relation to other attributes on non-fertilized seedlings. Height shows a

PROCEEDINGS

International Conference **REFORESTATION CHALLENGES**

03-06 June 2015, Belgrade, Serbia

stronger correlation to SDW and in most instances to H/D ratio. Diameter shows a stronger correlation to DQI and in most instances to RL (Table 5).

Table 4: Pearson coefficients of correlations between values of morphological attributes (SMA) of Turkish hazel seedlings (N=270).

SMA	ALL		CONTROL		OSMOCOTE		BACTOFIL		FLORIN	
	HT	DIA	HT	DIA	HT	DIA	HT	DIA	HT	DIA
DIA	0.76**	1.00	<u>0.76**</u>	1.00	0.75**	1.00	0.80**	1.00	<u>0.79**</u>	1.00
RL	0.06*	0.23**	0.35**	0.47**	0.44**	0.33**	0.35**	0.34**	0.21**	0.20**
SDW	0.81**	0.70**	0.68**	0.67**	0.70**	0.77**	0.70**	0.64**	0.70**	0.76**
RDW	0.82**	0.73**	0.78**	0.67**	0.69**	0.77**	0.74**	0.68**	0.69**	0.80**
H/D	0.74**	0.14**	0.53**	-0.15*	0.45**	-0.22**	0.61**	0.03	0.69**	0.10
DQI	0.58**	0.79**	<u>0.54**</u>	0.79**	0.43**	0.81**	0.55**	0.71**	0.38**	0.75**

Correlation significant at the 0.01 level is marked with **. Correlation significant at the 0.05 level is marked with *.

Table 5: Pearson coefficients of correlations between values of morphological attributes (SMA) of Service tree seedlings (N=270).

SMA	ALL		CONTROL		OSMOCOTE		BACTOFIL		FLORIN	
	HT	DIA	HT	DIA	HT	DIA	HT	DIA	HT	DIA
DIA	0.79**	1.00	0.80**	1.00	0.78**	1.00	0.83**	1.00	0.85**	1.00
RL	-0.26**	0.09**	0.44**	0.46**	0.47**	0.47**	0.42**	0.44**	0.52**	0.56**
SDW	0.85**	0.58**	0.81**	0.79**	0.77**	0.73**	0.74**	0.68**	0.66**	0.65**
RDW	0.54**	0.69**	0.82**	0.79**	0.71**	0.70**	0.79**	0.81**	0.76**	0.71**
H/D	0.77**	0.23**	0.66**	0.09	0.57**	-0.06	0.56**	0.02	0.24**	-0.29**
DQI	0.60**	0.84**	0.64**	0.85**	0.59**	0.84**	0.59**	0.83**	0.62**	0.82**

Correlation significant at the 0.01 level is marked with **. Correlation significant at the 0.05 level is marked with *.

Table 6: Pearson coefficients of correlations between values of morphological attributes (SMA) of wild cherry seedlings (N=270).

SMA	ALL		CONTROL		OSMOCOTE		BACTOFIL		FLORIN	
	HT	DIA	HT	DIA	HT	DIA	HT	DIA	HT	DIA
DIA	0.82**	1.00	0.67**	1.00	0.83**	1.00	<u>0.81**</u>	1.00	<u>0.82**</u>	1.00
RL	0.20**	0.29**	0.64**	0.36**	0.30**	0.37**	0.56**	0.53**	0.35**	0.46**
SDW	0.87**	0.74**	0.79**	0.81**	0.82**	0.78**	0.75**	0.71**	0.78**	0.77**
RDW	0.85**	0.82**	0.77**	0.85**	0.84**	0.82**	0.80**	0.78**	0.77**	0.78**
H/D	0.64**	0.10**	0.57**	-0.21**	0.49**	-0.08	0.43**	-0.17**	0.41**	-0.17**
DQI	0.69**	0.87**	0.42**	0.89**	0.68**	0.88**	0.56**	0.84**	0.55**	0.82**

Correlation significant at the 0.01 level is marked with **. Correlation significant at the 0.05 level is marked with *.

Height shows stronger correlations in most instances for wild cherry seedlings treated with Osmocote. Diameter shows stronger correlations to SMA of control, except to RL. Height shows a stronger correlation to H/D ratio and in most instances to SDW.

Diameter shows a stronger correlation to DQI and in most instances to RL. Diameter shows a stronger correlation to DQI (Table 6).

Seedling height and diameter explained different portions of SMA variation (Table 7). Height explained a large portion of DIA variation for Turkish hazel, service tree and wild cherry. Except for black walnut, seedling height explained the larger portion of morphological attributes variation. This is not the case with DQI, with larger portion of variation explained by DIA for all five species. Except for service tree, height explained the larger portion of RDW variation.

Table 7: Coefficients of determination (r^2) of seedlings height and diameter to other morphological attributes of five wild fruit species

SMA	black walnut		walnut		Turkish hazel		service three		wild cherry	
	HT	DIA	HT	DIA	HT	DIA	HT	DIA	HT	DIA
DIA	0.17	1.00	0.16	1.00	0.58	1.00	0.62	1.00	0.67	1.00
RL	0.24	0.18	0.11	0.16	0.00	0.05	0.07	0.01	0.04	0.08
SDW	0.24	0.46	0.44	0.19	0.66	0.49	0.72	0.34	0.76	0.55
RDW	0.41	0.40	0.48	0.32	0.67	0.53	0.29	0.48	0.72	0.67
H/D	0.26	0.31	0.64	0.04	0.55	0.02	0.59	0.05	0.41	0.01
DQI	0.06	0.74	0.01	0.59	0.34	0.62	0.36	0.71	0.48	0.76

DISCUSSION

Seedling size

Heights of black walnut seedlings were comparable, but diameters were smaller resulting in more spindly seedlings compared to previously reports for one-year old seedlings (Rietveld and Van Sambeek 1989, Oršanić et al. 2007). Walnut seedlings sizes were comparable with one-year old seedlings reported by Hemerey (2000) and Ćirković-Mitrović et al. (2012). Service tree seedlings were shorter than reported by Miko and Gažo (2004). Turkish hazel seedlings were taller, but diameters were comparable to reported by Ninić-Todorović et al. (2012). Wild cherry seedlings were smaller than half of height with much smaller diameters compared to one-year old seedlings reported by Yucedag and Gailing (2012) but comparable with seedling size reported by Stjepanović and Ivetić (2013). These differences in seedling sizes can be explained by different growing densities and cultural practices.

Relation between seedlings morphological attributes

Seedling morphological attributes tends to be strongly correlated (Oliet et al. 2009) but these correlations can vary between tree species (Baninasab and Mobli 2008). Relation between morphological attributes is often cofounded by the cultural practices employed to attain the target size (Mexal and Landis 1990). This study offers a unique perspective in robustness of relation between morphological attributes due to different fertilization in consequent three-year repeated trial.

Seedling diameter tends to be well correlated to other morphological attributes (Ritchie 1984), stronger compared to height with most attributes (Jinks and Mason 1998.

Binotto et al. 2010, Ivetić et al. 2013) except with H/D (Bayala et al. 2009, Li et al. 2011). Results in our study indicate opposite trend with stronger correlations of height to most other morphological attributes. Correlation between height and diameter of black walnut seedlings is comparable to those reported by Jacobs et al. 2006. Wild cherry seedlings correlations between height and diameter was lower than reported by Yucedag and Gailing (2012) but comparable to findings of Stjepanović and Ivetić (2013). Diameter was stronger correlated with most SMA only on black walnut seedlings. For other wild fruit species, height was stronger correlated to SMA except RL and DQI. More interestingly, for all species except for service tree, height was much stronger correlated to RDW than diameter. These results are opposite to previous reports about strong relation between stem diameter and root development (reviewed by Grossnickle 2012) and can be explained with favorable conditions for seedling development. In well-irrigated and nutrient rich environment seedling root are capable to supply shoot demand for water and minerals regardless to diameter.

CONCLUSIONS

Diameter was stronger correlated with other seedling morphological attributes only on black walnut seedlings. For other wild fruit species, height was stronger correlated to seedling morphological attributes except root length and Dickson Quality Index. More interestingly, for all species except for service tree, height was much stronger correlated to root dry weight than diameter.

In general, there is no significant effect of fertilization on relation between seedling morphological attributes. Results indicate non-destructive and easy to measure seedling morphological attributes like height and diameter as valid to use in seedling quality assessment programs, regardless to fertilization regime.

Acknowledgements: *The research is financed by the Ministry of Science and Technological Development of the Republic of Serbia. Project TR 31070 "The development of technological procedures in forestry with a view to an optimum forest cover realization" (2011-2014).*

REFERENCES

- Baninasab B., Mobli M. (2008). Morphological attributes of root systems and seedling growth in three species of Pistacia. *Silva Lusitana* 16:175-181.
- Baule A., Fricker C. (1978). Đubrenje šumskog drveća. Prevod sa nemačkog. JPŠC. Beograd.
- Bayala J., Dianda Z.M., Wilson Z.J., Oue'draogo S.J., Sanon Z.K. (2009). Predicting field performance of five irrigated tree species using seedling quality assessment in Burkina Faso. West Africa. *New Forest* 38:309-322.
- Binotto A.F., Lúcio A.D.C., Lopes S.J. (2010). Correlations between growth variables and the Dickson Quality Index in forest seedlings. *Cerne. Lavras/ Brasil* 16(4):457-464.
- Ćirković-Mitrović T., Brašanac-Bosanac Lj., Popović V. (2012). Effect of fertiliser application on morphological characteristics of walnut (*Juglans regia* L.) juvenile seedlings. International Conference on BioScience: Biotechnology and Biodiversity – Step in the Future. The Forth Joint UNS–PSU Conference. Novi Sad. June 18-20, 2012. Book of the Proceedings. Pp. 149-164.

PROCEEDINGS

International Conference REFORESTATION CHALLENGES

03-06 June 2015, Belgrade, Serbia

- Dickson A., Leaf A.L., Hosner J.F. (1960). Seedling quality – soil fertility relationships of white spruce and red and white pine in nurseries. *Forest Chron.* 36:237-241.
- Duryea M.L. (1984). Nursery cultural practices: impacts on seedling quality. In: Duryea ML, Landis TD. Editors: *Forest nursery manual: production of bareroot seedlings*. Boston (MA): Martinus Nijhoff/Dr. W. Junk Publishers. Pp. 143-164.
- Grossnickle S.C. (2012). Why seedlings survive: Importance of plant attributes. *New For.* 43:711-738.
- Haase D.L. (2006). Morphological and physiological evaluations of seedling quality. National Proceedings. Forest and Conservation Nursery Associations U.S. Department of Agriculture. Forest Service. Rocky Mountain Research Station. Proceedings RMRS-P-50. December 2007 Pp. 3-8.
- Haase D.L. (2008). Understanding Forest Seedling Quality: Measurements and Interpretation. *Tree Planters' Notes.* 52(2):24-30.
- Hemery G.E. (2000). *Juglans regia* L: genetic variation and provenance performance. DPhil. University of Oxford.
- Ivetić V. (2013). Textbook of seed and seedling production and afforestation. University of Belgrade – Faculty of Forestry. [On Serbian: Praktikum iz Semenarstva, rasadničarstva i pošumljavanja. Univerzitet u Beogradu – Šumarski fakultet.] 213 p.
- Ivetić V., Davorija Z., Vilotić D. (2013). Relationship between morphological and physiological attributes of hop hornbeam seedlings. *Bulletin of the Faculty of Forestry* 108 (39-50)
- Jacobs D.F., Wilson, B.C., Davis A.S. (2004). Recent trends in hardwood seedling quality assessment. In: Riley LE. Dumroese RK and Landis TD. technical coordinators. National Proceedings: Forest and Conservation Nursery Associations-2003. USDA Forest Service Rocky Mountain Research Station Proceedings RMRS-P-33. Pp. 140-144.
- Jacobs D.F., Woeste K.E., Wilson B.C., McKenna J.R. (2006). Stock quality of black walnut (*Juglans nigra*) seedlings as affected by half-sib seed source and nursery sowing density. *Acta Horticulturae* 705: 375-381.
- Jinks R., Mason B. (1998). Effects of seedling density on the growth of Corsican pine (*Pinus nigra* var. *maritima* Melv.). Scots pine (*Pinus sylvestris* L.) and Douglas fir (*Pseudotsuga menziesii* Franco) in containers. *Annales des Sciences Forestieres* 55: 407-423.
- Johnson J.D., Cline M.L. (1991). Seedling quality of southern pines. In: Duryea ML. Dougherty PM (eds.) *Forest regeneration manual*. Kluwer. Dordrecht. pp. 143-162.
- Landis T.D. (1984). Mineral nutrition as an index of seedling quality. In: Duryea ML (ed.) *Evaluating Seedling Quality: Principles. Procedures. and Predictive Abilities of Major Tests*. Workshop. October 16-18. 1984. For. Res. Lab.. Oregon S. U. Corvallis. Pp. 29-48.
- Landis T.D., Hasse D.L., Dumroese K.R. (2004). Plant nutrient testing and analysis in forest and conservation nurseries. Forest and conservation nursery associations, Charleston. Pp. 76-83.
- Li G.L., Liu Y., Zhu Y., Yang J., Sun H.Y., Jia Z.K., Ma L.Y. (2011). Influence of initial age and size on the field performance of *Larix olgensis* seedlings. *New Forest* 42: 215-226.
- Malakouti M.J., Homaei M. (2004). Soil fertility of arid and semi-arid regions (Difficulties and Solutions). Tarbiat Modares University Press. Tehran. Iran. 482 p.
- Mattsson A. (1996). Predicting field performance using seedling quality assessment. *New Forests* 13: 227-252.
- Mexal J.G., Landis. T.D. (1990). Target seedling concepts: height and diameter. In Proceedings: Combined Meeting of the Western Forest Nursery Association Target Seedling Symposium. U.S. Dep. Agric. For. Serv. Gen. Tech. Rep. RM-200. Pp. 17-36.
- Miko M., Gažo J. (2004). Morphological and biological characteristics of fruits and seed of the service tree (*Sorbus domestica* L.). *J Fruit Ornamental Plant Res.* 12: 139-146.

PROCEEDINGS

International Conference **REFORESTATION CHALLENGES**

03-06 June 2015, Belgrade, Serbia

- Ninić-Todorović J., Ognjanov V., Keserovic Z., Cerovic S., Bijelic S., Cukanovic J., Kurjakov A., Cabilovski R. (2012). Turkish hazel (*Corylus colurna* L.) Offspring variability as a foundation for grafting rootstock production. *Bulg. J. Agric. Sci.* 18: 883-888.
- Nordborg F., Nillson U. (2003). Growth, damage and net nitrogen uptake in *Picea abies* /L/ Karst seedlings effect of site preparation and fertilisation. Swedish university of Agricultural sciences. Alnarp. Sweden. Pp. 657-665.
- Oliet J., Planelles R., Artero F., Valverde R., Jacobs D., Segura M.L. (2009). Field performance of *Pinus halepensis* planted in Mediterranean arid conditions: relative influence of seedling morphology and mineral nutrition. *New For* 37: 313-331.
- Oršanić M., Drvodelić D., Kovačević I. (2007). Rasadnička proizvodnja sadnica crnog oraha (*Juglans nigra* L.). *Šumarski list*. 5-6: 207-217.
- Rietveld W.J., van Sambeek J.W. (1989). Relating black walnut planting stock to field performance. In: Rink G; Budelsky CA. eds. *Proceedings of the seventh central hardwood forest conference*. Gen. Tech. Rep. NC-132. St. Paul. MN: U.S. Depart. of Agriculture. Forest Service. North Central Forest Experiment Station. Pp. 162-169.
- Ritchie G.A. (1984). Assessing seedling quality. In: Duryea ML. Landis TD (eds.) *Forest nursery manual: production of bareroot seedlings*. Martinus Nijhoff/Dr. W. Junk Publishers. The Hague. Pp. 243-266.
- Stjepanović S., Ivetić V. (2013). Morfološki pokazatelji kvaliteta jednogodišnjih sadnica divlje trešnje (*Prunus avium* L.) sa golim korenom. *Glasnik Šumarskog fakulteta* 107. Univerzitet u Beogradu – Šumarski fakultet. Beograd. Pp. 205-216.
- Thompson B. (1982). Why fall fertilize. Southern Oregon State College. Ashland. Pp. 85-91.
- Thompson B.E. (1985). Seedling morphological evaluation: what you can tell by looking. In *Evaluating seedling quality: principles. procedures. and predictive ability of major tests*. Edited by Duryea ML. Forest Research Laboratory. Oregon State University. Corvallis. OR. Pp. 59-72.
- Van den Driessche R. (1990). *Mineral nutrition of conifer seedlings*. CRC press. Boca Raton. Florida. Pp. 1-183.
- Will R. E., Munger G.T., Zhang Y., Borders B. E. (2002). Effects of annual fertilization and complete competition control on current annual increment, foliar development, and growth efficiency of different Aged (*Pinus taeda*) stands. *Can. J. Forest Res.* 32(10): 1728-1740.
- Yucedag C., Gailing O. (2012). Effects of Seedbed Density on Seedling Morphological Characteristics of four Broadleaved Species. *Forest Systems*. [S.l.]. v. 21. n. 2: 218-222.

DYNAMIC OF GROWTH AND QUALITY OF ARIZONA CYPRESS (*CUPRESSUS ARIZONICA* GREENE) SEEDLINGS FROM THREE CONTAINER TYPES

Kolevska Dana Dina*, Trajkov Pande, Maletic Vladimir, Terziska Mare

*Corresponding author: dkolevska@sf.ukim.edu.mk

Kolevska D.D. *, Trajkov P., Maletic V., Terziska M. (2015). Dynamic of growth and quality of Arizona Cypress (*Cupressus arizonica* Greene) seedlings from three container types. In: Ivetić V., Stanković D. (eds.) Proceedings: International conference Reforestation Challenges. 03-06 June 2015, Belgrade, Serbia. Reforesta. pp. 78-87.

Abstract: The aim of this study was to investigate dynamics of development and morphological features of 1+0 (20 weeks old) Arizona Cypress seedlings raised in containers Yukosad (YS; hard plastic, 75cm³, 610 seedlings·m⁻²), Paperpot (PP; FH 508, 122 cm³, 614 seedlings·m⁻²) and Siset (SS; gray cardboard with white coating, 120 cm³, 589 seedlings·m⁻²). The seeds were sown into containers in four replications. After seed germination, every 15 days, i.e. 10 times during the vegetation season, 10 seedlings of each of 4 replications, i.e. 40 seedlings of each container were analyzed. Following features were measured: height (SH), root collar diameter (RCD), dry shoot weight (SDW), number, length and dry weight of I, II and III order lateral roots (FOLR, SOLR and TOLR) and of central root (CR). Quality indexes and ratios were calculated. Coefficients of correlation and determination as well as regression equations to express the dynamics of growth of selected features during the vegetation season were calculated.

Seedlings grown in containers YS had the highest values of all measured traits (SH, RCD, SDW, number, length and dry weight of FOLR, SOLR and TOLR), while seedlings grown in PP had the smallest values. However, PP seedlings had most favorable values of quality indexes and ratios (SQ, DQI, SDW/RDW and RDW/SDW ratio), while YS seedlings had the smallest values. SS seedlings were in the middle by their features. Coefficients of correlation between all analyzed traits reflect generally medium to strong dependence. Polynomial trend lines of dynamics of growth show that SH and RCD of the seedlings increase more or less linearly, while SDW, total number, length and weight of the roots increase most intensively in the second half of the growing season.

Key words: Arizona Cypress (*Cupressus arizonica* Greene), seedlings, containers, dynamics of development, quality.

INTRODUCTION

Arizona Cypress (*Cupressus arizonica* Greene) is a fast growing species which has been introduced in Macedonia more than 40 years ago and is widely used for afforestation in arid areas. Popovski and Stamenkov (1990) exposed results of afforestation with Arizona Cypress in the most arid region of Macedonia. Trees 9 years old on various soil types reached height of 3.20-4.14 m, diameter at 1.3 m of 4.5-6.7 cm and

have abundant fructification. For afforestation, both bare root and container seedlings of Arizona Cypress are used, however on severe ecological conditions of the planting site container seedlings are more preferred (Maiers et al. 1999). There are several papers dealing with features of Arizona and Mediterranean (common) Cypress seedlings produced in various types and volumes of containers: in Paperpot (Popovski and Levkova 1977), in containers of 115 - 656 mL volume (Loveall et al. 2002), in plastic polybags (Ahmadloo et al. 2012), in plastic containers Bosnaplast 12, Bosnaplast 18 and polybags (Topić et al. 2009). Generally seedlings from bigger containers perform better features and survival.

In this investigation was analyzed growth and development of one-year-old Arizona Cypress seedlings in three container types: "Yukosad", a hard plastic container which is the most used in Macedonia, Paperpot and for the first time was tested a new container Siset.

MATERIALS AND METHODS

The experiment was conducted in the nursery of PE "Macedonian forests", Forest Estate in Sveti Nikole, Macedonia. The nursery lies on flat terrain at about 277 m a.s.l. (41°52.082' N, 21°56.810' E). The average year air temperature is 12.9° C, average for vegetation period (April-October) is 18.8° C. The annual sum of precipitations is 472 mm.

One year old seedlings were raised in containers: Yukosad, hard-plastic, bullet-shape, h=10 cm, upper d=3.8 cm, bottom d=1.2 cm, volume=75 cm³, inside the container protrude 4 shallow ribs, one multipot contains 60 cells; Paperpot FH 508, 5 x 7.5 cm, vol. 122 cm³; container Siset (Patent No ISBN: 9989-2009-0-4) made of gray cardboard with white coating, cut into stripes. The stripes of 59 x 8 cm and 38 x 8 cm have incisions (notches) of 4 cm which allow assembling a multipot of 135 containers; each 4.2 x 3.8 x 8 cm. Assembled multipot is inserted into a plastic tray 59.5 x 38.5 x 8 cm.

The seed was collected from a local seed source, i.e. from trees of unknown provenance (to the date the seed source is not recognized and registered yet). Seed purity was 95%, germination 20%, the weight of 1,000 seeds 10.8 g. The containers were filled with Sphagnum peat Novobalt (pH 3.5-4). Five-seven seed per cavity were sown, on March 30 and containers were placed in open greenhouse on wooden construction 10 cm high. During the vegetation period regular nursery operations were conducted. Watering was performed on demand, 3-4 times per day with small quantity. After emerging of the seeds (2-3 week later), from each cavity the excess (supernumerary) seedlings were pulled out and only one seedling was left. The seedlings were weeded manually. Foliar fertilization was executed 4-5 times per week, from May 2 to July 25, with Folifertil T (water soluble, NPK 9:3:5, with microelements Cu 0.008%, Fe 0.017%, Mn 0.01%, Zn 0.003%), in concentration 0.02-0.2%. The seedlings were regularly treated against plant diseases and pests.

The experiment was conducted in randomized blocks in four replications. Each replication contained 10 multipots of each container type. Every two weeks, i.e. 10 times during the vegetation season until the seedlings reached age of 20 weeks, randomly of

each container type 10 seedlings of 4 replications, i.e. 40 seedlings were lifted for analyze. Total of 400 seedlings of each container type were analyzed.

The root systems were carefully washed out of the substrate. Height (SH, ± 0.1 cm) and root collar diameter (RCD, ± 0.1 mm) of fresh seedlings were measured. Then the shoot and root system were cut at root collar and the root system was divided on its parts. The length of the central (tap) root (CR), number and length of first (FOLR; all roots at the junction with the CR), second (SOLR) and third (TOLR) order lateral roots were counted and measured. Only roots longer than 1 cm were taken into account. Then the shoot and separated roots were dried on 80°C for 24 hours and dry weight of shoot, CR, FOLR, SOLR and TOLR were measured with accuracy of 0.01 g. Total root system dry weight (RDW) was calculated as a sum of dry weight of its parts (CR, FOLR, SOLR and TOLR). Following coefficients and ratios were calculated: Sturdiness coefficients (SQ; SH [cm]: RCD [mm]), ratio SDW [g]: RDW [g]; ratio RDW[g]:SDW[g]; Dickson's Quality index (DQI, Dickson et al. 1960) as: $DQI = \frac{SDW[g] + RDW[g]}{SH[cm] \cdot RCD[mm]} + \frac{SDW[g]}{RDW[g]}$.

According to measured and calculated data and parameters of the containers (volume, length, i.e. height, and diameter) following quality indicators were derived (Endean and Carlson 1975): rooting density (RODE; root dry weight [mg]/length of container [cm]) and rooting intensity (ROIN; dry weight of roots [mg] per unit rooting volume [cm³]).

Data analyses were performed using SPSS program version 20.0 for windows. One-way ANOVA was carried to determine whether the means of seedlings' traits were equal and t-test to separate differences. Pearson's coefficient of correlation (R) to test the relationship among the seedling traits and regression equations and coefficient of determination R² to express the trend of growth of selected featured were calculated using Excel 2010.

RESULTS

In Table 1 and Table 2 there are presented values of measured traits of the seedlings at the end of the growing season, i.e. at the age of 20 weeks.

Table 1. Quality features of the seedlings at the age of 20 weeks. Cont. = container type, YS = Yukosad, SS = Siset, PP = Paperpot, SH = shoot height, RCD = root collar diameter, SDW = shoot dry weight, RDW = roots dry weight, TDW = total dry weight, SQ = sturdiness coefficient, DQI = Dickson's quality index. RODE= rooting density, ROIN= rooting intensity. Means within column with different letters are significantly different at the $\alpha=0.05$ level. N=40.

Cont.	SH (cm)		RCD (mm)		SDW (g)		RDW (g)	TDW (g)	SQ	SH: SDW	RDW: SDW	DQI	RODE (mg/cm)	ROIN (mg/cm ³)	
	mean	SD	mean	SD	mean	SD									
YS	22.37 ^c	1.39	2.14 ^a	0.43	1.23 ^b	0.65	0,26	1.49	10,45 ^b	18,2	4,73 ^b	0,20 ^b	0,10 ^b	26	3,467
SS	20.84 ^b	1.36	2.11 ^a	0.40	0.94 ^{ab}	0.37	0,23	1.17	9,88 ^{ab}	22,17	3,70 ^a	0,27 ^a	0,08 ^a	31	1,917
PP	17.06 ^a	1.02	1.94 ^a	0.42	0.72 ^a	0.33	0,21	0.93	8,79 ^a	23,7	3,43 ^a	0,29 ^a	0,08 ^a	28	1,721

YS seedlings, growing in container with the smallest volume, have the highest values of all measured traits, but less favorable quality indexes and ratios. PP seedlings have lowest values of all measured traits but they have most favorable values of quality

PROCEEDINGS
International Conference **REFORESTATION CHALLENGES**
03-06 June 2015, Belgrade, Serbia

indexes and ratios. SS and PP seedlings despite of growing in containers of the same volume and similar dimensions differ from each other in morphological traits.

Table 2. Quality features of the root systems of the seedlings at the age of 20 weeks. For each trait mean and (SD) are given. Cont. = container type, CR = central (tap) root, YS = Yukosad, SS = Siset, PP = Paperpot, FOLR, SOLR, TOLR = I, II III order lateral roots respectively, RDW = roots dry weight.

Means within column with different letters are significantly different at the $\alpha=0.05$ level. N=40.

Cont.	CR	number of roots/seedling			length of 1 root/seedling (mm)			length of all lateral roots/seedling (mm)			dry weight of all lateral roots/seedling (g)			total of all orders lateral roots			total RDW (g)	
		FOLR	SOLR	TOLR	FOLR	SOLR	TOLR	FOLR	SOLR	TOLR	FOLR	SOLR	TOLR	number	length	weight		
YS	9,43 ^a (2,02)	0,09 ^a (0,04)	18,3 ^a (6,82)	62,6 ^a (37,90)	32,1 ^a (15,61)	7,41 ^a (4,91)	3,92 ^a (2,9)	2,03 ^a (1,4)	135,6 ^a (73,5)	245,4 ^a (159,9)	65,2 ^a (42,2)	0,09 ^a (0,04)	0,06 ^a (0,04)	0,02 ^a (0,02)	112,83	446,15	0,17	0,26
			<i>16,07^a</i>	<i>55,48</i>	<i>28,45</i>				<i>30,4</i>	<i>55,0</i>	<i>14,6</i>	<i>52,94</i>	<i>35,29</i>	<i>11,76</i>	<i>100,00</i>	<i>100,00</i>	<i>100,00</i>	
SS	9,55 ^a (2,0)	0,07 ^a (0,04)	10,33 ^b (5,43)	50,3 ^b (23,32)	28,0 ^b (13,86)	7,15 ^a (4,0)	3,41 ^b (2,85)	2,08 ^a (1,51)	73,9 ^b (46,9)	171,5 ^b (80,2)	58,2 ^a (34,4)	0,09 ^a (0,05)	0,05 ^a (0,03)	0,02 ^a (0,01)	88,63	303,62	0,16	0,23
			<i>11,66</i>	<i>56,75</i>	<i>31,59</i>				<i>24,3</i>	<i>56,5</i>	<i>19,2</i>	<i>56,25</i>	<i>31,25</i>	<i>12,50</i>	<i>100,00</i>	<i>100,00</i>	<i>100,00</i>	
PP	8,21 ^a (1,69)	0,07 ^a (0,04)	9,8 ^b (4,47)	36,9 ^c (20,22)	16,5 ^b (7,14)	6,73 ^b (3,95)	3,12 ^c (2,53)	2,0 ^a (1,42)	65,9 ^b (38,2)	115,1 ^c (61,5)	33,0 ^b (21,9)	0,08 ^a (0,04)	0,05 ^a (0,03)	0,01 ^b (0,01)	63,20	214,08	0,14	0,21
			<i>15,51</i>	<i>58,39</i>	<i>26,10</i>				<i>30,8</i>	<i>53,8</i>	<i>15,4</i>	<i>57,14</i>	<i>35,71</i>	<i>7,14</i>	<i>100,00</i>	<i>100,00</i>	<i>100,00</i>	

¹(italic) percent of total number, length and dry weight.

In the Table 2 quality features of the root systems at the end of the growing season are presented. Root systems of seedlings of various containers differ the most in the term of roots number. The YS seedlings, comparing to PP seedlings, have two times higher number of root of all orders, while SS seedlings lie between. Other root traits (length and dry mass) vary in rather narrow range. Relative participation of the number, length and weight of FOLR, SOLR and TOLR in the whole root system determines its fibrosity. SOLR together with TOLR in analyzed seedling types participate in rather close range: c/a 85-89% (number of roots), 70-75% (length), i.e. 43-47% (dry weight). RODE (root dry weight/length of container) and ROIN (dry weight of roots/unit rooting volume) of the seedlings from various containers are presented in the Table 1. RODE is lowest in YS (26 mg/1 cm) due to longer container, while in SS and PP has higher value (31, i.e. 28mg/1 cm, resp.) Contrary, ROIN has highest value in YS seedlings (highest RDW in smallest volume of 75 cm³), while in SS and PP (122, i.e. 120 cm³) this value is almost 50% lower.

Table 3. Pearson's coefficients of correlation between: SH=shoot height, RCD=root collar diameter, SDW = shoot dry weight, NFOLR=Number of first order lateral roots (FOLR), TNLR=Total number of lateral roots (LR), LFOLR=length of FOLR, TLLR=Total length of LR, WFOLR=weight of FOLR, TWLR=Total weight of LR, RDW=Total Roots dry weight. RODE = rooting density, ROIN = rooting intensity. Values of R not significant at $\alpha=0.05$ level. N=120.

	SH	RCD	SDW	NFOLR	TNLR	LFOLR	TLLR	WFOLR	TWLR	RDW
SH	1									
RCD	0.82	1								
SDW	0.78	0.87	1							
NFOLR	0.67	0.75	0.66	1						
TNLR	0.53	0.66	0.58	0.70	1					
LFOLR	0.51	0.60	0.63	0.56	0.47	1				
TLLR	0.41	0.52	0.37	0.60	0.69	0.58	1			

PROCEEDINGS
International Conference **REFORESTATION CHALLENGES**
03-06 June 2015, Belgrade, Serbia

WFOLR	0.62	0.72	0.53	0.63	0.35	0.72	0.35	1		
TWLR	0.52	0.78	0.57	0.45	0.58	0.34	0.67	0.5	1	
RDW	0.63	0.77	0.78	0.67	0.68	0.43	0.47	0.44	0.79	1

In Table 3 are presented coefficients of correlation (*R*) between shoot traits and some features of the root system. *R* between analyzed seedling traits generally reveals medium to strong dependence. *R* was calculated using data of all seedling types.

Dynamics of growth of the seedlings was analyzed using regression polynomial equations to express the changes in seedling traits during the 20 weeks of growth (Table 4).

Table 4. Regression equations of dynamics of growth of some seedlings traits during the vegetation season. SH = shoot height, RCD = root collar diameter, SDW = shoot dry weight, TNLR= total number of lateral roots (LR), TLLR=total length of LR, TWLR=total weight of LR, RDW=roots dry weight (total weight of all roots), RODE= rooting density, ROIN= rooting intensity.

	YS		SS		PP	
	y	R ²	y	R ²	y	R ²
SH	0,0261x ² + 0,5998x + 0,3052	0,89	0,0188x ² + 0,6907x - 0,0392	0,80	0,0169x ² + 0,5352x + 0,0047	0,82
RCD	0,0025x ² + 0,0268x + 0,4585	0,65	0,0063x ² - 0,0491x + 0,7348	0,74	0,0043x ² - 0,0181x + 0,6647	0,76
SDW	0,0057x ² - 0,0693x + 0,1965	0,78	0,0049x ² - 0,0517x + 0,1215	0,70	0,0029x ² - 0,0197x + 0,0288	0,71
TNLR	0,3721x ² - 2,8593x + 10,202	0,71	0,4162x ² - 4,6367x + 15,879	0,78	0,2315x ² - 1,3924x + 4,8307	0,75
TLLR	1,723x ² - 17,023x + 48,13	0,77	1,5751x ² - 19,27x + 58,732	0,79	0,925x ² - 8,1152x + 22,092	0,80
TWLR	0,0005x ² - 0,0031x + 0,0057	0,65	0,0009x ² - 0,0106x + 0,0265	0,71	0,0007x ² - 0,0074x + 0,0172	0,66
RDW	0,0008x ² - 0,0045x + 0,0128	0,76	0,0012x ² - 0,0153x + 0,0477	0,63	0,0009x ² - 0,0071x + 0,0145	0,60
RODE	0,0805x ² - 0,4527x + 1,2833	0,73	0,16x ² - 1,9269x + 5,75	0,65	0,1136x ² - 0,903x + 1,7333	0,78
ROIN	0,0107x ² - 0,0604x + 0,1712	0,69	0,0103x ² - 0,1273x + 0,3966	0,73	0,0071x ² - 0,0582x + 0,1186	0,70

DISCUSSION

Container grown seedlings, especially when planted on more adverse sites, has proven to be more successful than bare root, offer more opportunities to manage seedling growth, form, hardiness and physiological condition (Romero et al. 1986). Quality of container seedlings is influenced by many factors, but most researchers emphasize the container volume and seedlings density. Number of papers refer that seedling size is positively related to container volume (Endean and Carlson 1975, Maiers et al. 1999, Derby 2005, Topić et al. 2009, Pinto et al. 2011). In our investigation, however, is the opposite case. YS seedlings grown in volume of 75 cm³ have highest values of all measured traits and differ from seedlings from bigger containers. On the other side, SS and PP seedlings, even though grown in almost identical volume of 120 and 122 cm³, differ in morphological traits. Similar results are recorded (Popovski and Levkova 1977, Annapurna et al. 2004). Simpson (1994) explains similar case by some aspect of container design such as drainage or construction material, which prevents the seedlings in the larger containers from achieving the greatest growth. Seedlings of various container volumes perform various survival and growth rate after planting. Higher survival and growth of seedlings from bigger container state Ivetić and Škorić (2013), Maiers et al. (1999), Amidonet al. (1982). Some investigators (Loveall et al. 2012, Simpson 1994) however, found that seedlings from smaller containers, especially in the early stage of

development, may outperform those from bigger ones. Kolevska and Trajkov 2012 state that production technology did not influence growth and vitality of YS and PP trees of Austrian Pine of age 4-17.

Density as number of containers per unit area has also various influence on seedlings quality. Barnett et al. (1986), Jinks et al. (1998) state that container volume is less critical than seedling density. Container seedlings quality increases with corresponding decrease in growing density (Landis 1990). Opposite opinion exposes Scarratt (1972), who concludes that increasing aerial spacing of seedlings does not compensate a low soil volume. Our study confirms this, since the container density of YS and PP seedlings is almost the same (610, i.e. 614 cavities per m²) but the seedlings quality differs significantly.

Above-ground morphology is not always considered as accurate predictor of performance after outplanting (Davis and Jacobs 2005); however it is the first step to evaluate the seedling quality. Our results of seedling traits of all containers outperform finds of other investigators, dealing with containers of similar type or size. Popovski and Levkova (1977) expose results of seedlings production in Paperpot containers. Arizona Cypress seedlings grown in FH 408, 508 and 608 had SH 16.54 cm, 15.36 cm, 14.38 cm and RCD 2.88 mm, 2.44 mm, 2.32 mm respectively. Maiers et al. (1999) examined Arizona cypress seedlings from four container types (115 cm³, 164 cm³, 262 cm³ and 656 cm³). In volume 115 cm³ which is close to SS and PP in our investigation, SH=15.4 cm, RCD=1.82 mm, RDW=0.37 g, SDW=1.30 g, RDW:SDW=0.29. Our SS and PP seedlings have higher SH and RCD but much lower SDW and RDW, even though RDW:SDW is also 0.29 (in PP).

Seedlings quality indexes, as SQ, DQI, SDW:RDW, RDW:SDW etc. which are considered to have influence in predicting field performance (Thompson 1984, Barnett et al. 1986, Tsakalidimi et al. 2013) in our investigation differ between container types. Barnett et al. (1986) consider that root/shoot ratios between 0.45-0.65 (in our study 0.2-0.29) appear to produce seedlings that achieve balanced root and shoot growth, providing maximal potential for field survival. Stjepanović and Ivetić (2013) state that optimum SDW:RDW for container seedlings is 2:1 or even less (3.4 to 4.7 in our study). Our results for DQI in SS and PP seedlings (0.08) are slightly lower than the threshold of 0.09, suggested by Roller (1977), while in YS seedlings just above this value (0.10). Generally, values of all indexes of quality determine seedlings with high and thin shoot and low root mass.

Seedlings of various containers from our study differ in root system morphology. Davis and Jacobs (2005) state that root morphology (i.e., fibrosity, volume, length, area, number of FOLR, or a combination of traits) can provide an important indicator of potential for water and nutrient uptake. RDW itself doesn't describe roots morphology, even it is considered that seedlings with heavier roots are better (Stjepanović and Ivetić 2013). Root fibrosity, even its definition and method of evaluation differ in many investigators (Davis and Jacobs 2005) generally is meant as participation of high order roots in the whole root system.

In our investigation seedlings of all container types have high fibrosity of root systems, in the term of number, length and weight. Even though we recorded significant differences between absolute values of these parameters, relative distribution of first,

second and third order roots in the root system vary in rather narrow range. YS seedlings developed highest number and length of roots, c/a twice as PP seedlings.

However, high root fibrosity in container of small volume in the same time represents high root intensity and density (Endean and Carlson 1975), which can prerequisite root system deformations (Kolevska 2012). Endean and Carlson (1975) proved that rooting volume restriction on seedling growth is related to rooting intensity (ROIN). ROIN increases as the container volume decreases, i.e. in container volume of 66 cm³ was 7.54 mg·cm⁻³, in volume of 131 cm³ was 4.87 mg·cm⁻³. The growth of seedlings was reduced significantly after reaching "critical" ROIN of 0.45 mg·cm⁻³ (and bigger), when total dry weight was reduced. In our investigation ROIN in YU containers was 3.47mg·cm⁻³, in SS and PP 1.92 and 1.72 mg·cm⁻³ respectively, i.e. YS seedlings has twice higher values than PP.

Our investigation on coefficient of correlation between seedling traits confirms finds of many authors (Binotto et al. 2010, Jinks et al. 1998). Above ground traits are in stronger mutual correlation than between root features. Shoot:root correlation is stronger between NFOLR and WFOLR:SH, RCD and SDW, and between RDW and SH, RCD and SDW. RCD is in stronger correlation with other investigated features than SH and SDW. Total lateral root number, length and weight are in medium to strong correlation with traits of FOLR and weak to medium correlation with other root traits. Binotto et al. (2010) found high correlation between SH and RCD and SDW, RDW and total DW of the seedlings in *Pinus elliotii*. Similar results expose Oliet et. al. (2009) for *Pinus halepensis*. Topić et al. (2009) found that container volume was in strong positive correlation with RCD, RDW and SDW in seedlings of *C. sempervirens*. In our study, contrary, smaller container volume produced larger seedlings. Jinks et al. (1998) in *Pinus nigra*, *P. sylvestris* and *Pseudotsuga taxifolia* established very strong positive correlation between RCD and SDW, RDW and total DW, but SH was strongly negatively correlated with SDW, RDW and total DW only in *P. nigra*.

Dynamics of growth of the seedlings during the season, expressed as trendlines of polynomial regression reveal that SH and RCD increase more or less linearly during 20 weeks. Constant height and thickness growth until November-December is regular occurrence in Arizona Cypress in nurseries in Macedonia. SDW, total number, length and weight of the lateral roots and total RDW, however, increase most intensively in the second half of the growing season, i.e. after 12 -14 weeks of age. Intensive growth of all analyzed traits continues even when the fertilization of seedlings was interrupted at the end of July. RODE starts to grow intensively after 8-10 weeks. ROIN in SS and PP seedlings increases after 14 weeks, and in YS seedlings already after 8-9 weeks and surpass considerably SS and PP seedlings. Lyr and Hoffmann (1967) exposed course of root and shoot growth of different tree species in root laboratory. In *Picea abies* and *Pinus sylvestris* they determined a "Quercus type" of growth of shoot and roots, with various intensity and duration of growth for both species. Generally SH starts grow about mid-May and interrupts about the end of June. Roots grow for longer period during the season, from the beginning of May until the end of November (*P. sylvestris*), i.e. beginning of October (*P. abies*).

Differences in seasonal growth of five species found Baker (1988). He measured seasonal growth traits of 1+0 Radiata pine and 2+0 Red beech, Corsican pine, Ponderosa pine and Douglas fir seedlings grown at New Zealand. He found that period of rapid shoot growth (when weekly shoot growth exceeded 3% of total season's growth), varied considerably between the species and lasts 1.5 month at Corsican and Ponderosa pine up to 5.5 months at red beech. In our investigation on Arizona Cypress, rapid shoot growth with two-weekly shoot growth, which exceeds 6% of total season's growth, lasts 4.5 months.

CONCLUSIONS

Seedlings grown in containers YS had the highest values of all measured morphological traits, while seedlings grown in PP had the smallest values. Most favorable values of quality indexes and ratios have PP seedlings. SS seedlings were in the middle by their morphological features. This container type satisfies prerequisites for quality seedlings production. Coefficients of correlation between analyzed traits reflect generally medium to strong dependence. Polynomial trendlines of dynamics of growth show that SH and RCD of the seedlings increase more or less linearly, while SDW, total number, length and weight of the roots increase most intensively in the second half of the growing season. RODE and ROIN start increase earlier and most intensively in YS seedlings.

REFERENCES

- Ahmadloo F., Tabari M., Yousefzadeh H., Kooch Y., Rahmani (2012). Effects of soil nutritional status on seedling nursery performance of Arizona cypress (*Cupressus arizonica var arizonica* Greene) and Medite cypress (*Cupressus sempervirens var. horizontalis* (Mill.) Gord). African Journal of Plant Science Vol. 6(4), pp. 140-149, 27 February, 2012.
- Amidon T.E., Barnett J.P., Gallagher H.P., McGilvray J.M. (1982). A field test of containerized seedlings under drought conditions. In: Proceedings of the Southern Containerized Forest Tree Seedling Conference. 25-27 August, 1981, Savannah, GA, pp. 139-144.
- Annapurna D., Rathore T.S., Joshi G. (2004). Effect of container type and size on the growth and quality of seedlings of Indian sandalwood (*Santalum album* L.). Australian forestry. 2004 June, v. 67, no. 2. p. 82-87.
- Baker G. (1988). Seasonal growth characteristics of red beech, Corsican pine, ponderosa pine, radiata pine, and Douglas fir nursery seedlings. New Zealand Journal of Forestry, 32(4): 22–24 (1988), p. 22–24.
- Barnett J.P., Brissette J.C. (1986). Producing southern pine seedlings in containers. U.S.D.A. Forest Serv., South. Forest Exp. Sta., New Orleans, La. Gen.Tech. Rep. SO-59.72 p.
- Binotto A.F., Dal' Col Lúcio A., Lopes S.J. (2010). Correlations between growth variables and the Dickson quality index in forest seedlings. Cerne, Lavras, v. 16, n. 4, p. 457-464, out./dez. 2010.
- Davis A.S., Jacobs D.F. (2005). Quantifying root system quality of nursery seedlings and relationship to outplanting performance. New Forests (2005) 30:295–311.
- Derby S.A., Hinesley, L.E. (2005). Growth of Containerized White Cedar Seedlings as affected by container Volume, Substrate, Fertilization, and Irrigation. HortScience Vol. 40(6): 1755-1759.

PROCEEDINGS
International Conference **REFORESTATION CHALLENGES**
03-06 June 2015, Belgrade, Serbia

- Dickson A., Leaf A. L., Hosner J. F. (1960). Quality appraisal of white spruce and white pine seedling stock in nurseries. *Forestry Chronicle*, v. 36, p. 10-13.
- Endean F., Carlson L.W. (1975). The effect of rooting volume on the early growth of lodgepole pine seedlings. *Canadian Journal of Forest Research* 5:55-60.
- Ivetić V., Škorić M. (2013). The impact of seeds provenance and nursery production method on Austrian pine (*Pinus nigra* Arn.) seedlings quality. *Ann. For. Res.* 56(2): 297-305.
- Jinks R., Mason B. (1998). Effects of seedling density on the growth of Corsican pine (*Pinus nigra* var. *maritima* Melv.), Scots pine (*Pinus sylvestris* L.) and Douglas-fir (*Pseudotsuga menziesii* Franco) in containers. *Annales des sciences forestières*, 1998, 55 (4), pp.407-423.
- Kolevska D.D. (2012). Root deformations of Austrian Black Pine (*Pinus nigra* Arn.) seedlings and trees in stands raised by various stock type seedlings. *Forestry Ideas*, 2012, vol. 18, No 2, (44): 177-188.
- Kolevska D.D., Trajkov P. (2012). Quality and development of containerized seedlings and stands of Austrian black pine (*Pinus nigra* Arn.) in the Republic of Macedonia (FYROM). *Forestry Ideas* 18(1-43): 19-27.
- Landis T.D. (1990). Containers: types and functions. In: Landis, T.D., Tinus, R.W., McDonald, S.E., Barnett, J.P. *The Container Tree Nursery manual*, Volume 2. *Agric. Handbk.* 674. Washington, DC: U.S. Department of Agriculture, Forest Service: 1-39.
- Loveall M., Maiers R.P., Harrington J.T. (2002). Influence of site preparation and stock size on the establishment of Arizona cypress plantings in the Middle Rio Grande Region. In: Dumroese, R. K.; Riley, L. E.; Landis, T. D., technical coordinators. *National proceedings: forest and conservation nursery associations-1999, 2000, and 2001. Proceedings RMRS-P-24.* Ogden, UT: U.S. Department of Agriculture Forest Service, Rocky Mountain Research Station. p. 317-326.
- Lyr H., Hoffmann G. (1967). Growth Rates and Growth Periodicity of Tree Roots. *International Review of Forestry Research*, vol. 2. 1967. 181-236.
- Maiers R.P., Harrington J.T., Fisher J.T. (1999). Stock Size and Site Preparation Effects on Establishment of Eldarica Pine and Arizona Cypress in the Pecos River Valley. *Proceedings Of The International Conference On Desert Development; Desert Development; The endless frontier*, p. 423-435.
- Oliet J.A., Planelles R., Artero F., Valverde R., Jacobs D.F., Segura, M.L. (2009). Field performance of *Pinus halepensis* planted in Mediterranean arid conditions: relative influence of seedling morphology and mineral nutrition. *New Forests* (2009) 37:313-331.
- Pinto, J.R., Marshall, J.D., Dumroese, R.K., Davis, A.S., Cobos, R.D. 2011. Establishment and growth of container seedlings for reforestation: A function of stock type and edaphic conditions. *Forest Ecology and Management* 261 (2011) 1876-1884.
- Popovski P., Stamenkov M. (1990). Results of afforestation of arid terrains of Mid-Povardarje. (In Macedonian). *Book of papers of Savetovanje "Savremene metode pošumljavanja, nege i zaštite u očuvanju i proširenju šumskog fonda Srbije"*. Arandjelovac 1990. Pp.259-270.
- Popovski P., Levkova P. (1977). Rezultati četvorogodišnje proizvodnje I pošumljavanja papirpot sadnicama u SR Makedoniji 1974-77. (Results of four years of production and afforestation of Paperpot seedlings in SR Macedonia). *Simpozijum o primeni papirpot sistema u proizvodnji šumskih sadnica pri modernom tehnološkom procesu pošumljavanja*, Skopje, 1977. 29 p.
- Roller K.J. (1977). Suggested Minimum Standards for Containerised Seedlings in Nova Scotia. *Canadian Forestry Service, Department of the Environment, Information Report M-X*, 69 pp.
- Romero A.E., Ryder J., Fisher J.T., Mexal J.G. (1986). Root System Modification of Container Stock for Arid Land Plantings. *Forest Ecology and Management*, 16 (1986) 281-290.

PROCEEDINGS
International Conference **REFORESTATION CHALLENGES**
03-06 June 2015, Belgrade, Serbia

- Scarratt J. B. (1972). Effect of tube diameter and spacing on the size of tubed seedling planting stock. Environ. Can.. Can. For. Serv., Great Lakes For. Res. Centre, Sault Ste. Marie, Ont., Inf. Rep. 0-X-170.
- Simpson D. G. (1994). Nursery Growing Density and Container Volume Affect Nursery and Field Growth of Douglas -fir and Lodgepole Pine Seedlings. In Landis, T.D.; Dumroese, R.K., technical coordinators. Proceedings, Forest and Conservation Nursery Associations. 1994, July 11-14; Williamsburg, VA. Gen. Tech. Rep. RM-GTR-257. Fort Collins, CO: U.S. Department of Agriculture, Forest Service, Rocky Mountain Forest and Range Experiment Station: 105-115.
- Stjepanović S., Ivetić V. (2013). Morphological indicators of the quality of one-year-old bare-root seedlings of wild cherry (*Prunus avium* L.). Bulletin of the Faculty of Forestry 107: 205-216.
- Thompson B.E. (1984). Seedling morphological evaluation -what you can tell by looking. Proceedings: Evaluating seedling quality: principles, procedures, and predictive abilities of major tests. Workshop held October 16-18, 1984. Forest Research Laboratory, Oregon State University, Corvallis, ISBN 0-87437-000-0. p. 59-71.
- Topić V., Butorac L., Đurđević Z., Kekelić B., Jelić G. (2009). Utjecaj tipa kontejnera na rast i razvoj sadnica običnog čempresa (*Cupressus sempervirens* var. *Pyramidalis* Nyman) u rasadniku i šumskoj kulturi (Effect of container type on growth and development of seedlings of common cypress (*Cupressus sempervirens* var. *Pyramidalis* Nyman) in nurseries and forest cultures). Šumarski list br. 3-4, CXXXIII (2009), 121-134.
- Tsakalidimi M, Ganatsas .P, Jacobs D.F. (2013). Prediction of planted seedling survival of five Mediterranean species based on initial seedling morphology. New Forests 44:327-339.

RELATIONSHIPS BETWEEN SPECIFIC LEAF AREA AND MACRONUTRIENT CONCENTRATIONS OF PEDUNCULATE OAK (*QUERCUS ROBUR L.*) LEAVES

Batos Branislava, Miletić Zoran, Miljković Danijela

Batos B., Miletić Z., Miljković D. (2015). Relationships between specific leaf area and macronutrient concentrations of pedunculate oak (*Quercus robur L.*) leaves. In: Ivetić V., Stanković D. (eds.) Proceedings: International conference Reforestation Challenges. 03-06 June 2015, Belgrade, Serbia. Reforesta. pp. 88-98.

Abstract: The aim of the study was to examine the impact of macronutrient concentrations (N, P, K, Ca, and Mg) on specific leaf area (SLA) as a trait highly sensitive to environmental conditions. We studied pedunculate oak leaves (150 trees) in five populations in Serbia. Two populations are located in central Serbia near Belgrade city ('Ada Ciganlija' and 'Bojcin forest'), one in the northwest ('Sombor'), one in the north ('Subotica') and one in the west of Serbia ('Vrsac').

According to the results of ANOVA statistically significant differences between populations were obtained both for SLA and for macronutrient concentrations (all $p < 0.05$). The leaves from 'Bojcin forest' had the highest values of SLA, followed by the leaves from 'Ada Ciganlija' ($161.67 \text{ cm}^2 \text{ g}^{-1}$ and $31.85 \text{ cm}^2 \text{ g}^{-1}$, respectively). The highest concentrations of N, K and Mg in leaves were observed in 'Ada Ciganlija' population, the highest value for P in the population of 'Vrsac', while leaves from the populations 'Ada Ciganlija' and 'Sombor' had the highest concentration of Ca.

Multiple stepwise regressions were conducted to evaluate whether the concentrations of macronutrients in leaves could be used as reliable predictors of SLA. Regression equations were significantly correlated for SLA ($F_{(3,142)} = 4.13$ $p < 0.0034$). According to the observed statistically significant values of the multiple correlation coefficient, the variance of SLA ($R = 0.32$) can be predicted using the concentration of P in leaves with approximately 11% ($R^2 = 0.11$). The same result was obtained for the value of the leaf mass per area (SMASS), which can be predicted using the concentration of P with 7%, and the dry leaf mass (MASS) using the concentration of Ca with 7%. The significant value of t -test allows us to include the scores of the above macronutrients in the equation.

According to the observed results, the value of SLA not only depends on the physiological status of the individual, but also on other factors within the plant itself and in surrounding environmental conditions which together support its overall development and growth.

Key words: macronutrients, multiple stepwise regression, pedunculate oak, specific leaf area.

INTRODUCTION

Pedunculate oak (*Quercus robur L.*) is one of 10 native oak species that grow in the territory of Serbia. It is most common in the valleys of major rivers (the Sava and Danube rivers) in northern Serbia. It is highly adaptable to different climatic conditions,

but not to different types of soil. It requires deep and fertile soils that are constantly fed by groundwater and periodically flooded. The most valuable pedunculate oak forests in Serbia grow in the valley of the river Sava on alluvial, sandy-loam to clay, fertile soils. Pedunculate oak is the edifying species of the Serbian forest of pedunculate oak and ash *Querceto - Fraxinetum serbicum mixtum* Job. 1951 (Jovanović 1971, Tomić 2004).

Today, pedunculate oak is not as widely-distributed as it used to be. This applies to the whole range of its distribution, including Serbia (Yakovlev and Kleinschmidt 2002; Kovačević and Orlović 2007, Helama et al. 2009). The main causes are the global climate change and impaired regeneration of pedunculate oak forests. The changing site conditions affect the concentration of nutrients in the soil and their utilization by plants.

Plants accumulate nutrients in all organs, but the highest concentrations are in the leaves. There are many factors that affect the adoption and content of nutrients in the leaf: leaf type, age and physiological state of the plant, time of year, availability of nutrients in the soil, climate and soil conditions and others. (Santa Regina et al. 1997, Tremolieres et al. 1999, Covelo et al. 2008). The leaf is a very delicate plant organ that responds to environmental changes in order to achieve optimum adaptation to new conditions. The reactions may be visible (morphological abnormalities, colour change, pathological changes), and less visible (physiological/ultrastructural changes) (Bussotti et al. 2000). They differ between species but also between individuals of the same species, because they respond differently to the same or similar environmental conditions, which is all related to the whole structure of the plant and its habitat (Charles and Garten 1976, Gallardo and Covelo 2005, Nikolić et al. 2006, Nikolić and Orlović 2001). Of all leaf traits, specific leaf area and less variable dry leaf mass are of particular interest (Wilson et al. 1999). Specific leaf area and its relationship with the content of nutrients, especially N and C, are used in the study of seasonal and annual variability of photosynthetic activity, growth, biomass production, etc. Therefore, the leaf is taken as the main subject in the studies of environmental impacts on forest ecosystems.

Pedunculate oak in Serbia has been most often studied in the field of taxonomy, regeneration and silviculture, forest protection, etc., mainly at the level of species (Gajic et al. 1982; Erdesi 1985; Gajic, Tesic 1992; Bobinac 2007; Milanovic et al. 2008). In recent years, there has been an increasing research interest in the changes at population and individual levels in the field of morphology, anatomy, phenology, secondary metabolites, *in vitro* culture (Nikolic et al. 2006; Kovacevic, Orlovic 2007; Rakic et al. 2007; Batos 2010; Batos et al. 2012; Batos et al. 2014a; Batos et al. 2014b).

The aim of this research study was to investigate: 1) the impact of nutrients in the soil on their content in the leaf, 2) the impact of nutrients on leaf morphological traits, and 3) the extent to which environmental conditions affect leaf morphological traits and population differentiation.

MATERIALS AND METHODS

Site characteristics

We analyzed five pedunculate oak populations at five locations in Serbia: two of them are located in central Serbia in the immediate vicinity of Belgrade ('Ada Ciganlija', 'Bojcin forest'), one in the northwest ('Sombor'), one in the north ('Subotica') and one in

the west of Serbia ('Vrsac'). The populations grow in the conditions of continental to humid continental climate, at the sites whose ecophysical characteristics are favourable for the growth of pedunculate oak, though they differ in climate, geology, soil and other site characteristics (Table 1).

Leaves were sampled from 28 - 31 randomly selected trees in each population (150 trees in total). Only vital trees around 60 - 80 years old were selected for the purpose of morphological analysis and the analysis of macronutrient content. Leaf sampling was carried out in the same year, in late August and early September. We cut off 40 - 70 cm long branches from each tree, at a height of 3 - 5 m, from the outer portion of the lower third of the crown with all four aspects, and then transported them in plastic bags to the laboratory. In the laboratory, we selected only the leaves from the first phase of growth, which were further dried and ground for the purpose of foliar analysis, taking into account the identification of trees and population (Oliveira *et al.* 1996; Kremer *et al.* 2002).

Soil analysis - Analysis of physical and chemical properties of soil

A soil profile was opened in each of the five analyzed populations and the type of soil was determined. Samples for the laboratory testing of standard physical and chemical properties of soil were taken from the soil profiles. They were taken at fixed depths of 0 - 5 cm, 5 - 10 cm, 10 - 20 cm and 20 - 40 cm in order to standardize sampling conditions.

The soil sample analyses included:

- the total content of humus (organic carbon - C) by wet digestion in the mixture of potassium dichromate ($K_2Cr_2O_7$) and sulphuric acid (H_2SO_4) by the method of Tyurin (Skoric, Racz 1996),
- the content of total nitrogen (N) by Kjeldah method (Dzamic 1966),
- the content of the plant readily available forms of phosphorus (P) and potassium (K) by the AL method of Egner-Richm (Dzamic *et al.* 1996), where P is determined by colorimetry, and K by flame photometry.

The amounts of the analyzed macronutrients obtained for each soil layer were multiplied with the layer bulk density and volume per square meter. By adding up the obtained amounts of nutrients per soil layer we calculated the available amount of nutrients per square meter.

Foliar analysis

The sampled fresh leaves were air-dried, ground to powder, and dried in an oven at 40°C/24h. Further dry burning at 550°C produced ash which was used to determine all elements except N. All incombustible elements obtained from the ash were converted into chlorides, applying multiple evaporation in a solution of 10% HCl and weighed into 100ml containers. The samples were then used to determine: the content of P by colorimetry with the use of $SnCl_2$, the content of K and Na using flame photometry and the content of Ca and Mg by titrimetry with titriplex III as titration agent. The total N was determined by Kjeldah method (Dzamic *et al.* 1966).

Leaf morphological analysis

From the sample of 100 dried leaves, a subsample of 10 leaves was drawn for each tree. It was used for the purpose of morphological analysis (1,500 leaves in total). The leaves were scanned and analyzed using the computer program *Image Tool*. We determined the leaf area AREA (cm²) and the dry leaf mass MASS (g) and calculated the specific leaf area SLA (=AREA/MASS) (cm² g⁻¹) and the leaf mass per area SMASS (=100*MASS/AREA) (gcm⁻²).

Statistical analysis

To estimate the individual and population share in the phenotypic variation of the analyzed traits, we used the multivariate analysis of variance (MANOVA). To rank the average values of the analyzed traits we used LSD multiple range test with the significance level $\alpha=0.05$. The regression relationship between the dependent variables (morphological leaf traits and concentrations of macronutrients in the leaves) and the independent variables (concentrations of macronutrients in the soil) was determined using the results produced by multiple stepwise regression analysis. Data analysis was conducted using statistical software application STATISTICA 10.

RESULTS

Most of the studied populations have hydromorphic soil ('Ada Ciganlija', 'Bojcin forest', 'Sombor', 'Vrsac'). Only the population 'Subotica' has terrestrial soil (arenosol). The investigated soil types differ significantly in their physical and chemical properties. They belong to the textural class of clay ('Ada Ciganlija' - fluvisol calcaric, 'Bojcin forest' - planosol dystric, 'Sombor' - gleysol calcaric, 'Vrsac' - gleysol mollic) to loamy sands ('Subotica' - arenosol calcaric). By the reaction of the soil solution they are acidic (planosol dystric - 'Bojcin forest') to alkaline (fluvisol calcaric - 'Ada Ciganlija' and arenosol calcaric - 'Subotica') (Table 1).

The largest amount of the total N (kg/m²) in the soil was found in 'Ada Ciganlija' population. It was followed by 'Vrsac' and 'Sombor' populations, while 'Bojcin forest' had a significantly smaller and 'Subotica' the smallest amount of N. Plant readily available P was most abundant in gleysol mollic of 'Vrsac' population, followed by fluvisol calcaric in 'Ada Ciganlija' population. Planosol dystric and gleysol calcaric in 'Bojcin forest' and 'Sombor' populations had lower contents of plant available P. Extremely small amounts of available P were found in the arenosol soil type of 'Subotica' population. The populations 'Ada Ciganlija', 'Bojcin forest' and 'Sombor' are rich in plant readily available forms of K while the populations 'Subotica' and 'Vrsac' have low amounts of this mineral (Table 1).

According to the results of the leaf morphological analysis, 'Ada Ciganlija' and 'Bojcin forest' populations differ significantly in the leaf area (AREA). It is larger in 'Ada Ciganlija' than in 'Bojcin forest' population (55.91 cm² vs. 46.87 cm²). Likewise, the leaves of 'Ada Ciganlija' population have higher dry leaf mass (MASS) than 'Bojcin forest' population (0.44 g vs. 0.30 g). The other three populations, 'Sombor', 'Subotica' and

PROCEEDINGS
International Conference **REFORESTATION CHALLENGES**
03-06 June 2015, Belgrade, Serbia

`Vrsac`, don't show significant differences with regard to the specified parameters (Figure 1).

Table 1. General characteristics and macronutrient content of the five *Quercus robur* L. populations.

Populations	Ada Ciganlija	Bojcin forest	Sombor	Subotica	Vrsac
Coordinates	44°48' N 20°24' E	44°43' N 20°10' E	45°46' N 18°56' E	46°07' N 17°18' I	45°07' N 21°25' I
Altitude	70-76 m	77-78 m	83-86 m	137 m	76-80 m
Association	<i>Quercetum farnetto-cerris</i> Rud. 1949	<i>Carpino-Quercetum roboris</i> Raus 1969	<i>Carpino betuli- Quercetum roboris</i> Anic 1959	<i>Quercetum roboris</i> Jov. et Tomic 1979	<i>Carpino-Fraxino- Quercetum roboris</i> Mis. et Broz 1962
Mean annual temperature	13.2° C	12.5° C	11.6° C	11.4° C	12.0° C
Max. annual temperature	38.5° C	37.7° C	38.4° C	36.6° C	37.0° C
Min. annual temperature	-15.2° C	-24.0° C	-26.5° C	-23.5° C	-24.4° C
Sum of annual precipitation	521.0 mm	512.2 mm	449.3 mm	491.3 mm	485.4 mm
Parent material	Sandy sediments	Loess clay	Les	Les	Schists
Soil	Fluvisol calcaric	Planosol dystric	Gleysol calcaric	Arenosol calcaric	Gleysol mollic
C kg/m²	34.87	11.47	26.66	3.59	10.56
N kg/m²	2.98	1.17	2.185	0.63	2.40
C/N	11.7	9.8	12.2	5.7	4.4
P₂O₅ g/m²	23.7	8.2	3.6	2.2	34.4
K₂O g/m²	96.3	71.0	118.8	37.1	51.3
N% in leaf	2.61	2.20	2.27	2.52	2.45
P% in leaf	0.15	0.21	0.16	0.15	0.23
K% in leaf	1.27	1.22	1.18	1.11	1.22

Climate data are from the `Republic Hydrometeorological Service of Serbia`, for 2003

According to the results of ANOVA analysis, statistically significant effects of the site were obtained for SLA and the concentration of macronutrients (all $p < 0.05$). The leaves from `Bojcin forest` had higher SLA values than the leaves from `Ada Ciganlija` site ($161.67 \text{ cm}^2 \text{ g}^{-1}$ vs. $131.85 \text{ cm}^2 \text{ g}^{-1}$). The highest concentrations of N, K, and Mg were obtained for the leaves of `Ada Ciganlija` population, the largest value of P in the population of `Vrsac`, while the leaves from the populations of `Ada Ciganlija` and `Sombor` had the highest concentration of Ca.

Multiple regression analysis was conducted to obtain the coefficients in the regression equations and assess their statistical significance. They were then used to predict concentrations of individual macronutrients in the leaves of pedunculate oak and morphological leaf characteristics (dependent variables) using the values of macronutrient concentrations in the soil (independent variables).

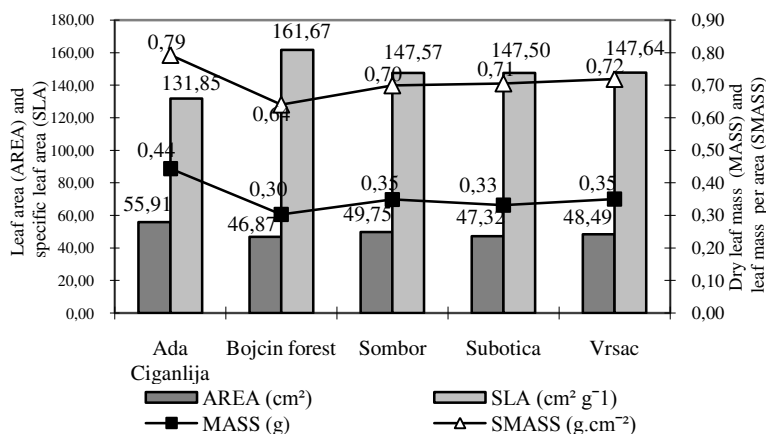

Figure 1. Morphometric characters of pedunculate oak leaves in the analyzed populations

According to the results of the significance tests (F-test all $p > 0.05$) and the t -test (all $p < 0.05$, data not show), the concentrations of the analyzed macronutrients in the soil cannot be used to predict the content of individual macronutrients in the leaf by stepwise multiple regression analysis (Table 2).

Table 2. Regression equations obtained by stepwise multiple regression analysis - interdependence of individual concentrations of macronutrients in the pedunculate oak leaf and concentrations of the analyzed macronutrients in the soil.

Equations regression	Multiple Correlation coefficient R	R Square
$N(\% \text{ in leaf}) = 2.4344 + 0.0001N_{(g/m^2 \text{ of soil})} - 0.021614 C/N$	0.5197	0.2701
$F_{(2,2)} = 0.3701, p < 0.7298$		
$P(\% \text{ in leaf}) = 0.1611 + 0.0014 P_{2O_5(mg/m^2 \text{ of soil})}$	0.5206	0.2711
$F_{(1,3)} = 1.1156, p < 0.3684$		
$K(\% \text{ in leaf}) = 1.1383 + 0.0008 K_{2O(mg/m^2 \text{ of soil})}$	0.4531	0.2053
$F_{(1,3)} = 0.7745, p < 0.4435$		

The assessment of the interdependence between individual leaf morphological traits and leaf macronutrient content produced the following results. The concentration of the analyzed macronutrients cannot be used to predict AREA since the significance test produced statistically insignificant results $F_{(3,142)} = 2.6267, p < 0.0527$ (Table 3).

Based on the obtained statistical significance of the test $F_{(3,142)} = 3.4049, p < 0.0195$, we can conclude that the linear relationship of the content of Ca and P in the leaf significantly correlate with the estimated dry leaf mass (MASS). The value of the multiple correlation coefficient $R = 0.2591$ indicates that we can predict the dry leaf mass (MASS) with 7% ($R^2 = 0.0671$) using the obtained values of Ca and P concentrations. The values of β coefficient obtained for Ca and P may be included in the equation for the prediction of MASS because they both had statistically significant t -test results Ca: $t = 2.11, p < 0.036$; P:

$t = -2.03$, $p < 0.04$). The concentrations of other macronutrients, N and C, cannot be included because the t - test results were statistically insignificant ($p > 0.05$) (Table 3).

The values of β coefficient for the concentration of P can be included in the linear regression equation to estimate SMASS based on the statistically significant results of the t -test ($P: t = -2.25$, $p < 0.0259$). Furthermore, the obtained statistical significance of the test ($F_{(3,142)} = 3.8029$, $p < 0.0117$) indicates that this element correlates significantly with the multiple values of the leaf macronutrient content in assessing dry leaf mass and that this equation can predict the leaf dry mass with 7% ($R^2 = 0.07$) (Table 3).

SLA can be predicted with 11% ($R^2 = 0.1049$) using the obtained equation, as confirmed by the statistical significance of the test ($F_{(3,142)} = 4.1304$, $p < 0.0034$). The equation can include the values of β coefficients only for P as confirmed by the results of the t -test ($P: t = 2.89$, $p < 0.0045$) (Table 3).

Table 3. Regression equations obtained by multiple stepwise regression analysis - interdependence of individual morphological traits and leaf macronutrient content (% in leaf).

Equations regression	Multiple Correlation coefficient R	R Square
AREA = 42.8032 + 7.0758 K – 26.4578 P + 2.1856 Ca	0.2293	0.0527
$F_{(3,142)} = 2.6267$, $p < 0.0527$		
MASS = 0.3295 + 0.0414 Ca	0.2591	0.0671
$F_{(3,142)} = 3.4049$, $p < 0.0195$		
SMASS = 0.8118 – 0.5677 P	0.2727	0.0744
$F_{(3,142)} = 3.8029$, $p < 0.0117$		
SLA = 105.6336 +145.4964 P	0.3239	0.1049
$F_{(3,142)} = 4.1304$, $p < 0.0034$		

DISCUSSION

The presented research results do not show any significant correlations between the concentrations of macronutrients in the leaf and the available quantities of these elements in the soil. In predicting morphological leaf traits on the basis of the macronutrient contents in the leaf, we obtained low prediction percentages. Linear regression equations could include only the β coefficients calculated for P and Ca (MASS (7%) using the content of Ca, SMASS (7%) using the content of P and SLA (11%) based on the content of P in the leaf).

The low correlation coefficient between the content of macronutrients in the leaf and in the soil, which is not statistically significant, shows that the content of macronutrients in the leaf does not depend only on the quantity of these macronutrients in the soil, but on complex influences of a number of factors (Batos et al. 2014). The concentration of macronutrients in the plant biomass, plant growth, development and bioavailability of essential minerals in the soil depend on growth media structure, which is characterized by different factors (solubility of minerals, soil structure and pH) (Garnier et

al. 1997, Tremolieres et al. 1999, Knops, Reinhart 2000, Clemens 2001, Hagen-Thorn et al. 2004, Covelo et al. 2008, Ghandilyan et al. 2009, Batos et al. 2014a).

The highest mean annual temperature was recorded in the population `Ada Ciganlija`, where the pedunculate oak leaf has the largest area and the largest mass per area as well as the highest content of N, and the smallest content of P. However, the lowest amount of rainfall and consequently increased xerophilous character of the sites of `Sombor`, `Subotica` and `Vrsac` populations have caused the pedunculate oak leaf to have smaller area and higher mass per area and to contain less P, except in the population of `Vrsac` where the content of P in the leaf is significantly higher.

The obtained data are consistent with the data from the available literature stating that the small leaf area, high leaf mass per area and low content of N and P in the leaf are related to the increasing C content and the xerophilous character of the leaf, which occur as the plant's attempt to overcome stressful conditions of increased aridity (Reich et al. 1991, Castro-Diez et al. 1997 and references within, Bussotti et al. 2000, Ogaya, Penuelas 2007).

The age of the leaf affects dry leaf mass and specific leaf area, while the plant age affects leaf area and dry leaf mass (Reich et al. 1991, Karavin 2013). Specific leaf area is small after the budding, then it increases during the leaf expansion, after which it starts to decrease until early aging, when it increases again (Karavin 2013 and the references). The author concludes that there is no clear position on the impact of the leaf and plant age on specific leaf area, which calls for further studies on different species growing in different conditions.

According to Wilson et al. (1999), the reliability of using specific leaf area and leaf mass per area as parameters of plant strategy is controversial, since high variability may be due to genetic and environmental variability, both in space (shade leaves or sun-exposed leaves) and in time (seasonal and annual).

The results of the foliar analysis of individual and population variability in leaf macronutrients of pedunculate oak in Serbia (Batos et al. 2010) confirmed the significant impact of environmental factors on the content of macronutrients in the leaf. The obtained high concentration of alkaline earth elements in the leaf is the result of the high content of these elements in the soil (Batos et al. 2014). These results are directly related to the research of Miljkovic (1972) who states that they are brought into the soil by river sediments that are rich in carbonates of these elements. However, in some cases, despite their high quantities in the soil, they are not adequately adopted by plants (Letic et al. 2001, Batos et al. 2010). This further confirms the complex nature of the relationship between the soil and the plants or the variety of conditions necessary for the processes of organic matter mineralization, migration of nutrients through the soil profile and adoption by plants. (Orgeas et al. 2002, Seletkovic 2003, Canadell and Villa 2004, Xue et al. 2005, Kuznova et al. 2007).

Acknowledgements: *This work was funded as a subproject: "Forestry and mitigation of climate changes", of the project: "Studying climate change and its influence on the environment: impacts, adaptation and mitigation" (No. III 43007) by the Ministry of Education, Science and Technological Development of Serbia.*

REFERENCES

- Batos B. (2010). Population and individual variability of chemical markers - flavonoid and morpho - anatomical characteristics of the pedunculate oak (*Quercus robur* L.). D.Sc. thesis, Faculty of Agriculture, University of Novi Sad, pp 1-238 (in Serbian with English abstract).
- Batos B., Miljkovic D., Ninic-Todorovic J. (2012). Length of vegetation period as parameter of common oak (*Quercus robur* L.) phenological variability. *Genetika* 44 (1): 139-152.
- Batos B., Orlovic S., Miletic Z., Rakonjac Lj., Miljkovic D. (2014a). Population variability and comparative analysis of macroelements concentrations in pedunculate oak (*Quercus robur* L.) leaves and surrounding soils. *Archives of biological sciences, Belgrade* 64 (4): 1345-1355.
- Batos B., Jovanovic D., Miljkovic D. (2014b). Spatial and temporal variability of flowering in the pedunculate oak (*Quercus robur* L.). *Sumarski list* 7-8: 371-379.
- Bobinac M. (2007). Oplodna sječa u šumi hrasta lužnjaka i poljskog jasena u Srijemu i njene specifičnosti. *Rad. Šumar. Inst. Jastrebarsko* 42 (1): 35-46.
- Bussotti F., Borghini F., Celesti C. (2000). Leaf morphology and macronutrients in broadleaved trees in central Italy. *Trees* 14: 361-368.
- Canadell J., Vila M. (2004). Variation in tissue element concentrations in *Quercus ilex* L. over range of different soils. *Plant Ecology* 99-100 (1): 273-282.
- Castro-Diez P., Villar-Salvador P., Perez-Rontome C., Maestro-Martinez M., Montserrat-Marti G. (1997). Leaf morphology and chemical composition in three *Quercus* (*Fagaceae*) species along a rainfall gradient in NE Spain. *Trees* 11 (3): 127-134.
- Charles T., Garten J.R. (1976). Correlations between concentrations of elements in plants. *Nature* 261: 686-688.
- Clemens S. (2001). Molecular mechanisms of plant metal tolerance and homeostasis. *Planta* 212: 475-486.
- Covelo F., Duran J., Gallardo A. (2008). Leaf resorption efficiency and proficiency in a *Quercus robur* population following forest harvest. *Forest Ecology & Management* 255 (7): 2264-2271.
- Dzamic R. (1966). Određivanje ukupnog azota po Kjeldahu. Priručnik za ispitivanje zemljišta, knj. 1, Jugoslovensko Društvo za proučavanje zemljišta.
- Dzamic R., Stevanovic D., Jakovljevic M. (1996). Praktikum iz agrohemije.
- Erdesi J. (1985). Ikonografija hrasta lužnjaka Jugoslavije. Univerzitet u Beogradu, Glasnik šumarskog fakulteta 64: 109-164.
- Gajic M., Stojakov B., Sljivovacki S., Zivanov R. (1982). The species of oaks and their infraspecies forms on Delgblato sands. University in Belgrade, Bulletin of Colege of Forestry 58 (A): 55-61.
- Gajic M., Tesic Z. (1992). Species of oak genus (*Quercus* L.) in Serbia. Publication Institute of Forestry Belgrade.
- Gallardo A., Covelo F. (2005). Spatial pattern and scale of leaf N and P concentration in a *Quercus robur* population. *Plant and Soil* 273: 269-277
- Ghandilyan A., Ilk N., Hanhart C., Mbengue M., Barboza L., Schat H., Koornneef M., El-Lithy M., Vreugdenhil D., Reymond M., Aarts G. (2009) A strong effect of growth medium and organ type on the identification of QTLs for phytate and 18 mineral concentrations in three *Arabidopsis thaliana* RIL populations. *Journal of Experimental Botany* 60 (5): 1409-1425.
- Garnier E., Cordonnier P., Guillermin J.L., Sonie L. (1997). Specific leaf area and leaf nitrogen concentration in annual and perennial grass species growing in Mediterranean old-fields. *Oecologia* 111: 490-498.

PROCEEDINGS
International Conference **REFORESTATION CHALLENGES**
03-06 June 2015, Belgrade, Serbia

- Hagen-Thorn A., Armolaitis K., Callesen I., Stjernquist I. (2004). Macronutrients in tree stems and foliage: a comparative study of six temperate forest species planted at the same sites. *Ann. For. Sci* 61: 489-498.
- Helama S., Laanelaid A., Raisio J., Tuomenvirta H. (2009). Oak decline in Helsinki portrayed by tree-rings, climate and soil data. *Plant and Soil* 319: 163-174.
- Jovanovic B. (1971). *Dendrology with the principles of phytocoenology*, The University of Belgrade, Naučna knjiga, Belgrade.
- Karavin N. (2013). Effects of leaf and plant age on specific leaf area in deciduous tree species *Quercus cerris*. L. var. *cerris*. *Bangladesh J. Bot.* 42(2): 301-306.
- Knops J.M.H., Reinhart K. (2000). Specific Leaf Area Along a Nitrogen Fertilization Gradient. *American Midland Naturalist* 144 (2): 265-272.
- Kovacevic B., Orlovic S. (2007). Trends in vegetative propagation in Common oak (*Quercus robur* L.). *Poplar* 179/180: 63-70 .
- Kremer A., Dupouey J.L., Deans D., Cottrell J., Csaiki U., Finkeldey R., Espinel S., Jensen J., Kleinschmit J., Van Dam B., Ducouso A., Forrest I., Lopez de Heredia U., Lowe A., Tutkova M., Munro R.C., Steinhoff S., Badeau V. (2002). Leaf morphological differentiation between *Quercus robur* and *Quercus petraea* is stable across western European mixed oak stands. *Annals Forest Science* 59: 777-787.
- Kuznova E., Pechov M., Vocetkova M. (2007). The influence of climatic conditions on nitrogen uptake during the vegetative phases for sunflower "Bioclimatology and natural hazards" International Scientific Conference, Poľana and Detvou, Slovakia, September 17 - 20, 2007, ISBN 978-80-228-17-60-8.
- Letic Lj., Savic R., Bozinovic M. (2001). *Turbulent sand*. Monography, Edition "Tracks", Book 5, Public Enterprise "Palic-Ludas", Subotica.
- Milanovic S., Lazarevic J., Mrdakovic M., Vlahovic M., Miletic Z. (2008). Host plant effect on the activity of digestive enzymes of the *gypsy moth caterpillars*. *Bulletin of the Faculty of Forestry* 98: 127-142.
- Miljkovic N. (1972). Alluvial soils. In: Zivkovic B. et al. *Soils of Vojvodina*. Institute of Agricultural Research, Novi Sad 294-317.
- Nikolic P.N., Krstic D.B., Pajevic P.S., Orlovic S.S. (2006) Variability of Leaf Characteristics in Different Pedunculate Oak Genotypes (*Quercus robur* L.). *Proceedings for Natural Sciences, Matica Srpska*, 111: 95-105.
- Nikolic N., Orlovic S. (2001). Interclonal Variability of Certain Macroelement Content in Pedunculate Oak (*Quercus Robur* L.) leaf. XIV Symposium of the Yugoslav Society for Plant Physiology Programme and Abstracts of Announcements: Yugoslav Society for Plant Physiology: Goč. 44.
- Ogaya R., Penuelas J. (2007). Leaf mass per area ratio in *Quercus ilex* leaves under a wide range of climatic conditions. The importance of low temperatures. *Acta Oecologica* 31: 168-173
- Oliveira G., Martins-Loucao M.A., Correia O., Catarino F. (1996). Nutrient dynamics in crown tissues of cork-oak (*Quercus suber* L.). *Trees - Structure and Function* 10 (4): 247-254.
- Orgeas J., Ourcival J.M., Bonin G. (2002). Seasonal and spatial patterns of foliar nutrients in cork oak (*Quercus suber* L.) growing on siliceous soils in Provence (France). *Plant Ecology* 164: 201-211.
- Rakic S., Petrovic S., Kukuc J., Jadranin M., Tesevic V., Povrenovic D., Silerr-Marinkovic S. (2007). Influence of thermal treatment on phenolic compounds and antioxidant properties of oak acorns from Serbia. *Food Chemistry* 104 (2): 830-834.
- Reich P.B., Walters M.B., Ellsworth D.S. (1991). Leaf age and season influence the relationships between leaf nitrogen, leaf mass per area and photosynthesis in maple and oak trees. *Plant. Cell and Environment* 14: 251-259.

PROCEEDINGS
International Conference **REFORESTATION CHALLENGES**
03-06 June 2015, Belgrade, Serbia

- Santa Regina L., Rico M., Rapp M., Gallego H.A. (1997). Seasonal variation in nutrient concentration in leaves and branches of *Quercus pyrenaica*. *Journal of Vegetation Science* 8: 651-654.
- Seletkovic I. (2003). Dynamics of Biogenic Elements in Natural Stands and Forest Cultures of Peduncled Oak (*Quercus robur* L.). *Radovi* 38 (1): 65-96.
- Skoric A., Racz Z. (1996). Određivanje sastava humusa. Priručnik za ispitivanje zemljišta, Knjiga 1, Jugoslovensko društvo za proučavanje zemljišta, Beograd: 46-55.
- Tomic Z. (2004). Forestry Phytocoenology. Textbook, Faculty of Forestry of the University of Belgrade, Belgrade.
- Tremolieres M., Schnitzler A., Sanchez-Perez J.M., Schmitt D. (1999). Change in foliar nutrient content and resorption in *Fraxinus excelsior* L., *Ulmus minor* Mill. and *Clematis vitalba* L. after prevention of floods. *Ann For Sci* 56: 641-650.
- Wilson P.J., Thompson K., Hodgson J.G. (1999). Specific leaf area and leaf dry matter content as alternative predictors of plant strategies. *New Phytol.* 143: 155-162.
- Xue L., Xu Y., Wu M., Li Y. (2005). Seasonal patterns in nitrogen and phosphorus and resorption in leaves of four tree. *Acta Ecologica Sinica Journal of Sun Yatson University Social Science Edition* 25 (3): 520-526.
- Yakovlev L.A., Kleinschmidt J. (2002). Genetic Differentiation of Pedunculate Oak *Quercus robur* L. in The European Part of Russia Based on RAPD Markers. *Russian Journal of Genetics* 38 (2): 148-155.

SEEDLING PRODUCTION IN “GOČKO” CONTAINER

Škorić Mirko, Devetaković Jovana *

*Corresponding author: jovana.devetakovic@sfb.bg.ac.rs

Škorić M., Devetaković J. (2015). Seedling production in “Gočko” container. In: Ivetić V., Stanković D. (eds.) Proceedings: International conference Reforestation Challenges, 03-06 June 2015, Belgrade, Serbia. Reforesta. pp. 99-103.

Abstract: This paper presents up to date experiences with seedling production in “Gočko” container. This type of container can be easily produced on a mechanical device “Gočko” (patent Nr. MP 43/96). Trays with dimensions of 12 cm wide (W) X 18 cm long (L) and 20 cm high (H) are made of plastic film, with variable number of cells. Cells are made of craft paper with range of dimensions and volumes, from 2 (W) X 3 (L) cm (36 cells with volume of 120 cm³) up to 12 (W) X 18 (L) cm (1 cell with volume of 4,300 cm³). Container height can be various, up to maximum of 20 cm.

Up to date, seedling production in this type of container was tested on University of Belgrade – Faculty of Forestry. Beech (*Fagus sylvatica* L.) and Austrian pine (*Pinus nigra* var. *nigra* Arnold) seedlings were produced successfully. Beech seedlings after first growing season meet quality standards for this species (Šijačić et al. 2007). Austrian pine seedlings produced in this type of container were superior to bare-root and seedlings produced in containers made of hard plastic in the nursery (Ivetić and Škorić 2013) as well as in the field (Škorić 2014).

Key words: Gočko, stocktype, container seedlings, nursery production.

INTRODUCTION

Production of containerized seedlings started on mid 1970s and until today it has become common method for the production of forest seedlings together with traditional method of producing bareroot seedlings. Production of containerized seedlings has more advantages compared to production of bareroot seedlings, like: better shoot to root ration, greater root growth potential, handling practices (lifting, storage, transport and planting) are easier and safer, better survival on harsh sites, lower planting stress and better shoot and root growth after outplanting (Grossnickle and El-Kassaby 2015).

Over time, different types of containers were developed. Containerized seedlings are susceptible on root deformation which can result low planting success and future stability and growth (Halter et al. 1993). Quality of containerized seedlings is largely dependent of the container type and physical characteristics of container have great influence on seedlings, also as number of cells and container shape (Aphalo and Rikala 2003, Tsakalidimi et al. 2005, Dominguez-Lerena et al. 2006).

In Serbia, initially used were Paperpot and Koppafors containers. Afterwards, several types of containers developed locally are used, like Plantagrah, Jukosad, Pirosad and Nisula rolls (Škorić et al. 1997). During 1990s, mechanical machine “Gočko” was designed for the production of containers with soil bricks. The possibility of applying and seedlings quality was tested in the experiments that were carried out at the Forestry Faculty of Belgrade.

DESCRIPTION OF MECHANICAL DEVICE

The function of the machine is based on making cells with soil bricks which are used for seeding, planting seedlings or placing cuttings during production cycle. Cells, with plants or without, are made on machine in prismatic form of the same length with square cross section of different dimensions. In respect to species which need different size of cells for reforestation purposes, cells can be adjusted easily according to the need.

Operation demand one worker and production capacity of this machine directly depends on the size of desired cells. Worker prepares craft paper or plastic strip and soil mixture and after that same worker fills box for forming container. Soil mixture would be added in two layers, first layer – seedling /cutting – second layer. After formation on the first half, pressure bars are lifted and plants are placed. On each cell are placed two plants in opposite direction. Compression of soil mixture can be controlled so the same pressure can be used for all cells. Last operation is manually cutting cells on the necessary dimension i.e. depth of container/cell (Figure 2). If container is planned to be seeded, procedure is slightly different. Container with cells are formed completely, plastic strip sealed and formed package moved to cutting section where it is divided on necessary dimension and after that operation seed can be sown.

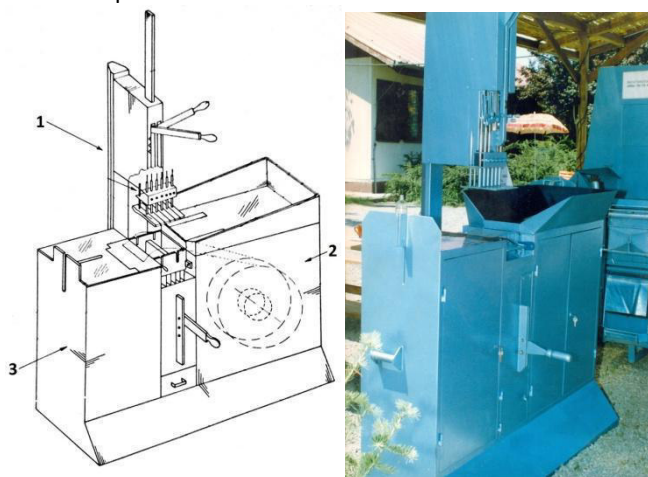

Figure 1: Mechanical device Gočko (patent nr. MP 43/96): 1 – Box for forming container with cells, 2 – Section for charging with soil mixture and plastic strip and 3 – Section for manually cutting cells with soil mixture and storage spare parts (left) and Photo (right).

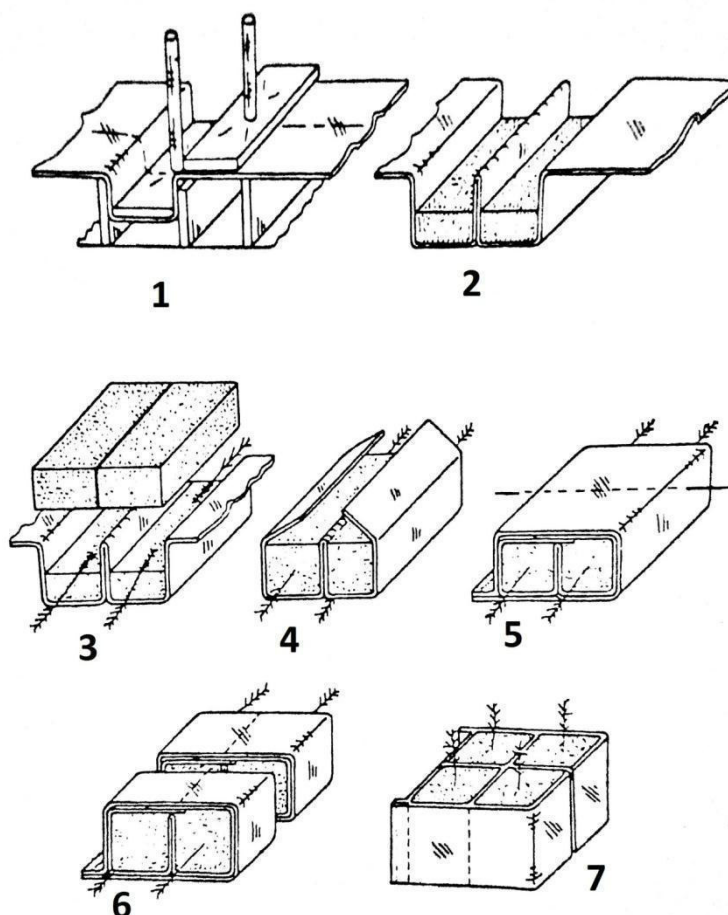

Figure 2: Forming of cells with plants: 1 – Folding and holding plastic strip, 2 – Forming first half of cell, 3 – Placing plant and forming second half of cell, 4 – Formed cells with plants, 5 – Sealed cells with plants, 6 – Cut cells with plants, 7 – Part of plant package destined to nursery.

Dimensions of container is 12 cm wide (W) X 18 cm long (L) and 20 cm high (H), with variable number of cells which is induced with different molds. Cells can be with range of dimensions and volumes, from 2 (W) X 3 (L) cm (36 cells with volume of 120 cm^3) up to 12 (W) X 18 (L) cm (1 cell with volume of $4,300 \text{ cm}^3$). Container height can be adapted to various, up to maximum of 20 cm.

Containers can be easily transported to the nursery (or from nursery to the field) in horizontal or vertical position since they are of squared shape. Before planting, craft paper or plastic strip are cut, collected and returned to be recycled.

DISCUSSION

Production of containerized seedlings is characterized by root deformation which indicates the need for new solutions (Rune 2003). On first look, container “Gočko” is similar to Nisula rolls from Finland and Brika from Russia, but it differs from both of them. Each seedling is completely separated one from each other as a difference from Nissula rolls and cells with a soil mixture are made on machine, namely performed ones are not need as a difference machine as a difference from Brika system.

A spiral root which is most common deformation are reduced with open bottom and prismatic form of cells, but it can be supported using chemical pruning on the smooth walls of cells (Wenny and Woollen 1989, Mc Donald 1983). On the other hand, mechanical pruning of roots during extraction of container will be left out (Rune 2003).



Figure 3: Seedlings of beech (left) and Austrian pine (right) in container “Gočko” in nursery of Faculty of Forestry-University of Belgrade

Seedling production in this type of container was tested on University of Belgrade – Faculty of Forestry. Beech (*Fagus sylvatica* L.) and Austrian pine (*Pinus nigra* var. *nigra* Arnold) seedlings were produced successfully. Beech seedlings after first growing season meet quality standards for this species (Šijačić et al. 2007) (Figure 3 – left). Austrian pine seedlings produced in this type of container were superior to bare-root and seedlings produced in containers made of hard plastic in the nursery (Ivetić and Škorić 2013), as well as in the field (Škorić 2014) (Figure 3 – right).

CONCLUSION

Mechanical device “Gočko” have some conditional benefits as:

- Same machine can be used for preparation containers for seeding, planting seedlings or for placing cuttings.
- Size of cells can be changed very easy by changing molds.
- There are not specific requirements to substrate.

- Possibility to choose material for making cells: craft paper, plastic and biodegradable plastics.
- One way container – there is no need to be collected on the field and returned to nursery for the next production period.
- Container can be transported on long distances without damages in horizontal or vertical position.
- This system has wide possibility of use, coniferous and deciduous forest seedling but not only for forestry, can it be use in agriculture and horticulture.

REFERENCES

- Aphalo P., Rikala R. (2003). Field performance of silver-birch planting-stock grown at different spacing and in containers of different volume. *New Forest* 24: 93–108.
- Dominguez-Larena S., Herrero Sierra N., Carasco Manzano I. Ocana Bueno L., Penuelas Rubira J.L., Mexal J.G. (2006). Container characteristics influence *Pinus pinea* seedling development in the nursery and field. *Forest Ecology and Management*. Volume 221, Issues 1–3: 63–71.
- Grossnickle S., El-Kassaby Y. (2015): Bareroot versus container stocktypes: a performance Comparison. *New Forests*. Online first: March 15, 2015.
- Halter M.R., Chanway C.P., Harpe G.J. (1993). Growth reduction and root deformation of containerized lodgepole pine saplings 11 years after planting. *For. Ecol. Manage.*, 56:131 - 146.
- Ivetić V., Škorić M., (2013). The impact of seeds provenance and nursery production method on Austrian pine (*Pinus nigra* Arn.) seedlings quality. *Ann. For. Res.* 56(2): 297-305.
- McDonald S.E., Tinus R.W., Reid C.P.P. (1983). Modification of Ponderosa Pine Root Systems in Containers. *J. Environ. Hort.* 2(1):1-5.
- Rune G. (2003). Slits in container wall improve root structure and stem straightness of outplanted Scots pine seedlings. *Silva Fennica* 37(3): 333–342.
- Šijačić-Nikolić M., Ivetić V., Knežević R., Milovanović J. (2007). Analysis of seed and seedling traits of different provenances of beech. *Acta biologica iugoslavica - serija G: Acta herbologica*, 16(1), 15-27.
- Škorić M. (2014): Effect of stocktype and provenance on Austrian pine (*Pinus nigra* Arnold) seedling quality and planting success – PhD Thesis, University of Belgrade – Faculty of Forestry. 143 pp. [In Serbian]
- Škorić M., Radojičić R., Isajev V., Mančić A. (1997). Semi-automatic machine for making soil bricks for containerization of plants. *Proceeding book of the 3rd ICFWST 97, September 29th – October 3rd, 1997, Belgrade and Mt. Goč, Serbia, Yugoslavia: 189-194*
- Tsakalimi M., Zagas T., Tsitsoni T., Ganatsas P. (2005). Root morphology, stem growth and field performance of seedlings of two Mediterranean evergreen oak species raised in different container types. *Plant Soil* 278: 85-93.
- Wenny D., Woollen R. (1988): Chemical Root Pruning Improves the Root System Morphology of Containerized Seedlings. *Western Journal of Applied Forestry*, Volume 4, Number 1, pp. 15-17(3).

Session 3:

MONITORING REFORESTATION SUCCESSES

**SOIL CARBON ACCUMULATION AS A RESPONSE TO THE AFFORESTATION
METHOD USED IN THE GRDELICA GORGE IN SOUTHEASTERN SERBIA**

Lukić Sara*, Kadović Ratko, Knežević Milan, Beloica Jelena, Đukić Vesna, Belanović Simić Snežana

*Corresponding author: sara.lukic@sfb.bg.ac.rs

Lukić S., Kadović R., Knežević M., Beloica J., Đukić V., Belanović Simić S. (2015). Soil carbon accumulation as a response to the afforestation method used in the Grdelica gorge in southeastern Serbia. In: Ivetić V., Stanković D. (eds.) Proceedings: International conference Reforestation Challenges. 03-06 June 2015, Belgrade, Serbia. *Reforesta*. pp. 104-116.

Abstract: Afforestation and reforestation as part of the strategy of mitigation of the global climate change have the potential to increase the binding capacity and storage of atmospheric carbon in terrestrial carbon pools. The choice of a particular afforestation method may affect the success of afforestation in the years after stand establishment. Long-term effects of the choice of afforestation method can be evaluated through ecosystem services provided by the afforested areas.

The aim of this research is to evaluate the impact of afforestation methods on C stock and soil C accumulation rate in the period between the 20th and 60th year after afforestation. The study was conducted in the area of the Grdelica Gorge in Southeastern Serbia in black pine stands established in mid-1950s by afforestation using the methods of planting in pits and in bench terraces.

A total of 4 soil profiles were opened in each of the seven sample plots located on slopes greater than 30%, in warm exposures (S, SW, and SE) and within an altitude ranging from 400 to 650 m. The traditional pipette method was used for particle size analysis. Bulk density was measured by drying cores at 30° C to constant weight and soil organic C according to the Tjurin method. The estimation of soil C stock and soil C accumulation rate were determined by the Tier 2 method as recommended by the IPCC Guidelines (2003).

According to the obtained results, the soil C stock in bench terraces was significantly higher than in the soils between the bench terraces and pit planted soils. In addition, the soil C accumulation rate was higher in the soils afforested by planting in bench terraces. Therefore, it can be concluded that the afforestation method of planting in bench terraces provides better long term conditions for soil C accumulation. This is particularly important in harsh site conditions prevailing in sites such as the Grdelica Gorge, where it is necessary to establish stable ecosystems and provide ecosystem services.

Keywords: afforestation, pit planting, bench terraces, black pine, C accumulation.

INTRODUCTION

Unsustainable harvesting and human induced inappropriate use of forested land is causing biodiversity loss, decreasing the ability of ecosystems for function and leading to reduced provision of ecosystem services (Bullock et al. 2011). The restoration of forest ecosystems and reforestation of degraded sites characterized by harsh conditions can provide significant support to sustainable development and improvement of human life through an enrichment in biodiversity and provision of ecosystem services (MEA 2005, Saches et al. 2009). In sites created by unplanned deforestation and inappropriate utilization, afforestation/reforestation are ways to allow for the establishment of vegetation (restoration or rehabilitation of forest sites) and mitigation of environmental conditions. Although forest restoration projects may include a number of activities, reforestation is almost always the key component (Harrington 1999). Bare land environments are characterized by unfavourable conditions for the establishment of vegetation due to microclimate characteristics and condition of the soils degraded by erosion processes. The afforestation of these sites can create ecosystems capable of providing various services. In addition to erosion control, which had previously been the primary aim of afforestation and reforestation (Harrington 1999), the potentials of forest ecosystems to bind C and mitigate climate change also stand out as important ecosystem services (Johnston et al. 1996; Moffat 1997; Post and Kwon 2000 ; Pan et al. 2011). The establishment of forest(s) in degraded harsh sites provides accumulation of atmospheric C in soil (Jobbagy and Jackson 2000, Lal 2005) and living biomass (Houghton 2005, Woodbury et al. 2007) as the most significant C sinks in terrestrial ecosystems. The land use which allows you to change degraded and marginal land into forest land has been recognized as a powerful strategy for atmospheric C binding and climate change mitigation (Richter et al. 1999, Lal et al. 2003, Wang and Medley 2004, Niu and Duiker 2006).

Forest restoration in degraded harsh sites requires particularly intensive modes of management, including the selection of appropriate species for afforestation (Panagopoulos and Hatzistathis 1995, Zhang et al. 2003, Cao et al. 2007), the need for the production of planting material of appropriate characteristics (stress resistant) (Valladares and Sanchez Gomez 2006, Ciccarese et al. 2012), the application of techniques which speed up the recovery of forests (Holl and Aide 2011, Ciccarese et al. 2012) and a proper selection of afforestation methods (Fonseca et al. 2011, Oliet and Jacobs 2012, Boetang et al. 2012).

Studies have shown that a proper choice of the afforestation method can affect the survival and early growth of newly established stands (Fonseca et al. 2011). Although the impact of the reforestation method and preparation of the soil for planting is mainly manifested in the first few years after afforestation, Boetang et al. (2012) argue that differences can also be observed in mature stands. Thus, the same authors claim that the method of preparation of the soil for afforestation has an impact on stand volume up to 20 years after afforestation. Carbon accumulation is particularly marked in living biomass (Richter et al. 1999, Hoover et al. 2000), and the method of afforestation can increase biomass production. This implies both a greater capacity for carbon accumulation in forest

ecosystems (Boetang et al. 2012, Fonseca et al. 2014) and improvement in soil properties.

Accordingly, the hypothesis is that the afforestation method affects the potentials of carbon accumulation in soils. The aim of this research is to estimate whether the afforestation method can affect the amount of C stock as well as the C accumulation rate in soil. With that respect, this paper is an attempt to provide guidelines for the selection of an appropriate afforestation method that can provide favourable conditions for carbon accumulation.

MATERIAL AND METHOD

Description of the research area

The area of the Grdelica Gorge covers up to 1,784.34 km² and extends between 42°22' and 42°55' N and 21°19' and 20°00' E (Figure 1). It is characterized by its developed hydrographic network with 137 torrential streams and a total catchment area of 1,700.33 km². The area of the Grdelica Gorge is a site marked by specific conditions (Kostadinov 1997) and vulnerable ecosystems requiring appropriate management methods.



Figure 1. The area of the Grdelica Gorge

The area of the Grdelica Gorge has a continental climate with an average annual air temperature of 10.9°C and the annual precipitation sum of 672 mm, according to the values observed between 1949 and 2011 (RHMZ Srbije, 1949-2011).

The harsh conditions in the area of the Grdelica Gorge are reflected in the erodibility of the parent rock displaying various degrees of weathering. The soils on this parent rock are often skeletal and dry, with a low pH and developed on steep slopes, which contributes to an increase in the intensity of erosion processes.

Studies of soil properties and erosion processes in the area of the Grdelica Gorge (Tanasijević et al. 1956) have shown that particularly erodible soils have developed on crystalline schists. The area of the Grdelica Gorge is diverse in terms of vegetation types present. It is characterized by rare and fragmentarily represented forest communities, as

well as both relict and endemorelict ones. The association of Hungarian oak and Turkey oak - *Quercetum frainetto-cerris* Rud. 1949 is the most common forest type in the area of the Grdelica Gorge at altitudes of up to 600 m. Montane beech forest - *Fagetum moesiacaе montanum* Jov. 1953 is also present in this region at higher elevations, i.e. from 800 to 1,300 m. In the valley of the South Morava River the most common communities are forests of pedunculate oak and broom - *Genisto elatae* – *Quercetum roboris* Horv. 1938 s. lat., and the forests of poplar and willow – *Salici* – *Populetum albae* Drees. 1936 (Tomić 2004). The same associations inhabited the degraded sites in the time before deforestation occurred.

Degradation in the area of the Grdelica Gorge is a result of both natural and anthropogenic factors. Anthropogenic impacts in the territory of the Grdelica Gorge are primarily related to deforestation for extensive and short-term agriculture, exhaustion and abandonment of arable land and deforestation and degradation of new areas. The combination of environmental factors and strong anthropogenic impacts (deforestation) has led to accelerated erosion and severe damage having been inflicted by frequent torrential floods (Ratknić et al. 2011).

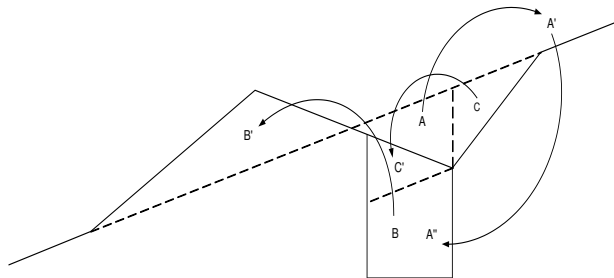

Figure 2. The method of bench terrace formation and planting

The most extensive reforestation of this area was carried out between 1954 and 1958 (Kostadinov 2007). One of the most common species used in the afforestation of degraded harsh sites in the Grdelica Gorge was black pine (*Pinus nigra* Arnold) due to its pioneering features and ability to survive in harsh environmental conditions. The most frequently used afforestation methods were planting in pits and in bench terraces. The method of pit planting involves excavation of pits for the planting of seedlings (Lorett and Bolander 1982, Vučićević 1995). The pit planting method does not require special preparation of the soil, which makes it more cost-effective. The pit planting of black pine was performed in 40 × 40 cm pits, with a 2 × 2 m spacing between the seedlings. The method of planting in bench terraces requires preparation of the terrain, i.e. contour line terracing by making cuts and fills, forming the flat part of the bench terrace with a counter slope where planting is performed (Lujčić 1973, Sheng 2002, Blanco and Lal 2008) (Figure 2). The method of planting in bench terraces also involves special mechanical soil preparation in the planting site. The root of the planted seedling is covered with earth that was previously on the surface, while the pit is backfilled with chipped material from

deeper layers of the profile (Soljanik 1952, 1955; Andrejević 1959, Đorović 1969, Đorović et al. 2003). Black pine was planted on the flat parts of bench terraces, along the contour line in 40 × 40 cm pits, with a spacing of 1-2 m between the seedlings and a distance of 8-10 m between two adjacent bench terraces.

Data collection

The study included a total of seven sample plots established in stands formed between 1956 and 1958 by afforestation with black pine using the methods of planting in pits and in bench terraces. Before afforestation, these sites were bare lands of exhausted and abandoned arable land.

Three sample plots (sp5, sp11 and sp12) were located in the stands established by pit planting and four sample plots (sp3, sp9, sp16 and sp22) in the stands established by planting in bench terraces. The average size of a sample plot was 0.47 ha, and their sizes ranged from 0.35 to 0.50 ha. The parent rock of the sample plots are schists. The observed soil type is leptosol of light mechanical composition and poorly expressed or unexpressed structure. In order to reduce the experimental error, all sample plots were placed on terrains with a slope of over 30%, in warm exposures (S, SW, SE), at altitudes ranging from 450 to 600 and in forests aged 58-60 years. No signs of plant diseases and insect attacks were observed in the sample plots, and until then no silvicultural measures were carried out in them. The above exposure and slope indicate the least favourable conditions for the establishment of vegetation (Soljanik 1955, Lujic 1960, Økland et al. 2003, Wang and Medley 2004).

Soil study

Four soil profiles were opened in each sample plot. The soil sampling was carried out at fixed depths of 0 – 5 cm, 5 – 10 cm and 10 - 20 cm. The laboratory analyses were performed on air dry soil samples. The analyses included determination of the following physical and chemical properties of the soil: the traditional pipette method was used for particle size analysis (ISO 11277); bulk density was measured by drying the cores at 30°C to constant weight (ISO 11272); soil organic carbon (C) was measured according to the Tjurin method (1965). All the analyses were performed in 2 replicates.

The data on soil properties in the same sample plots 20 years after afforestation were taken from the database of the Faculty of Forestry (Velašević et al. 1979) and the same methods were used to determine granulometric composition, BD and SOC.

Soil C stock evaluation

The Tier 2 method was used for the calculation of soil organic C density (SCD) according to the IPCC Guidelines (2003). The C stock in soil, for the sampling site is illustrated by the following equation:

$$SCD = \sum_{layer=1}^{layer=j} (SOC_{content} \cdot BD \cdot Depth \cdot (1 - frag))_{layer}$$

where: *SCD* – soil carbon density for *j* layers of sampling site ($Mg\ C \cdot ha^{-1}$), *SOC_{content}* – soil organic carbon content for the single sampled depth (% of mass or $g\ C \cdot kg^{-1}$), *BD* – soil mass of the undisturbed volume of the single sampled depth ($t\ m^{-3}$), *Depth* – thickness of the sampled layer (m), *frag* – volume of the coarse fragments in the single sampled depth (%).

Statistical analyses

Data distribution in the sample (normality) was determined on the basis of standard skewness and kurtosis. Significance of the difference between the amounts of C accumulated in soil in the 20th and the 60th year after afforestation by planting in pits and in bench terraces was tested by ANOVA. The differences in the carbon accumulation rate in the period from the 20th to 60th year after afforestation between the stands established by planting in pits and the ones established by planting in bench terraces were tested using the Student's t-test. The differences were considered significant at the level of probability of 95% ($p < 0.05$) - LSD test.

RESULTS

Soil properties and the C stock

A developed A soil horizon in all sample plots is an important indicator of progressive soil processes. Considering the same age of the stands and the fact that afforestation was carried out on soils with very sparse and stunted vegetation or no vegetation at all, the presence of A horizon indicates ameliorative effects of afforestation on the process of pedogenesis.

The studied soil is leptosol (WRB IUSS WG, 2006), which belongs to the sandy loam textural class. The 0-5 cm soil layer is quite humous (3-5%), while deeper layers of the profile have low humus content (1-3%). Soil density ranges from 1.27 to 1.39 $g \cdot cm^{-3}$, indicating medium compaction of the studied soils (Kachinskiy 1965).

Table 1. The C stock in soils afforested by methods of planting in pits and in bench terraces

Method/age	SCD _{Average} ($Mg \cdot ha^{-1}$)	s.d.	Difference	Range
pp/20yr	10.50	4.1	x	10.69
pp/60yr	24.63	12.3	x	29.50
bt/20yr	25.04	8.7	x	17.78
bt/60yr	80.34	27.4	x	70.12
F = 22.99		p = 0.000		

The differences in soil C stocks in the 20th and the 60th year after afforestation between the black pine stand afforested by pit planting and the one afforested by planting in bench terraces are statistically significantly different (Table 1). The largest statistically

significant C stock was found in the sites afforested by planting in bench terraces 60 years after afforestation ($80.34 \pm 27.4 \text{ Mg}\cdot\text{ha}^{-1}$). There are no statistically significant differences in carbon stock between the afforestation by planting in pits and in bench terraces after 20 years. Noticeably less C accumulated in the afforestation by pit planting after 20 years ($10.50 \pm 4.1 \text{ Mg}\cdot\text{ha}^{-1}$) (Figure 2) compared to the afforestation by planting in bench terraces.

The analysis of C stock 60 years after afforestation (Table 2) revealed the highest soil C accumulation in the lines of bench terraces ($80.34 \pm 27.4 \text{ Mg}\cdot\text{ha}^{-1}$) compared to the soil between the bench terraces ($29.73 \pm 5.5 \text{ Mg}\cdot\text{ha}^{-1}$) and soils afforested by pit plating ($24.63 \pm 12.3 \text{ Mg}\cdot\text{ha}^{-1}$) (Figure 3).

Table 2. The amount of C stock in soil 60 years after afforestation

Method/profile	SCD _{Average} ($\text{Mg}\cdot\text{ha}^{-1}$)	s.d.	Difference	Range
pp	24.63	12.3	x	29.50
bt/between	29.73	5.5	x	16.10
bt/in	80.34	27.4	x	70.12
F = 18.28 p = 0.000				

The soil C accumulation rate over the period from the 20th to 60th year after afforestation, shown in Figure 4, is higher for the afforestation by planting in bench terraces ($1.75 \pm 0.6 \text{ Mg}\cdot\text{ha}^{-1}$). In soils afforested by pit planting, the soil C accumulation rate in the same period reached $0.44 \pm 0.3 \text{ Mg}\cdot\text{ha}^{-1}$, being statistically significantly lower ($p < 0.01$).

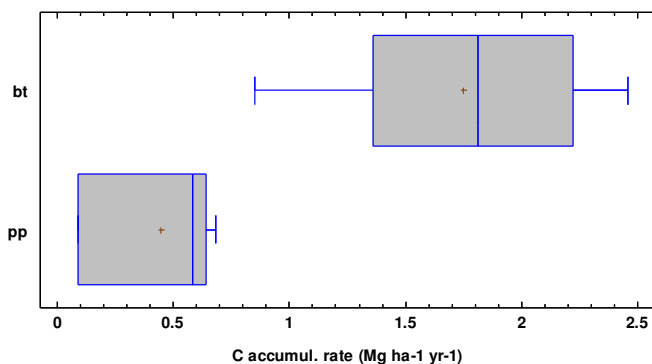

Figure 4. The C accumulation rate in soils afforested by methods of planting in pits and in bench terraces

DISCUSSION

The degradation of forest sites in the Grdelica Gorge is caused by deforestation and extensive farming in deforested areas. The afforestation and reforestation of degraded areas have both ecological and socio-economic impacts. The multifunctionality of forest ecosystems includes timber production, carbon absorption/emission (in above

and below ground biomass, soil, etc.), the hydrological function of forests, the function of erosion control, the protection of biodiversity and socio-cultural functions (recreation and tourism, aesthetic functions, etc.). The multifunctional character of forests can be manifested only if we abide by the principles of sustainable forest management. Familiarity with the principle of sustainability and its definition serve as the basis for the establishment of guidelines, principles and recommendations of the European afforestation policy, targeted at both general and institutional issues, as well as for the establishment of the legislative framework. They can also serve as the basic step in the determination of the significance and place of the current state of the environment and afforestation/reforestation projects within the framework of the Clean Development Mechanism (CDM) (IUCN 2004). Familiarity with the impacts of afforestation methods and techniques of soil preparation for planting on afforestation success and the promotion of the multifunctional character of forests represent a powerful decision making tool in the field of forest management and the definition of future land management strategies.

The primary goal of afforestation carried out in the territory of the Grdelica Gorge was erosion control. However, from today's perspective, many services and functions of forest ecosystems must not be ignored, including C accumulation and climate change mitigation.

According to the results obtained, the highest statistically significant soil C accumulation was recorded in bench terraces ($80.34 \pm 27.4 \text{ Mg}\cdot\text{ha}^{-1}$) 60 years after afforestation. Noticeably less C was accumulated in soils afforested by pit planting 20 years after afforestation ($10.50 \pm 4.1 \text{ Mg}\cdot\text{ha}^{-1}$), while the C stock in soils afforested by pit planting 60 years after afforestation ($24.63 \pm 12.3 \text{ Mg}\cdot\text{ha}^{-1}$) and of the ones afforested by planting in bench terraces 20 years after afforestation ($25.04 \pm 8.7 \text{ Mg}\cdot\text{ha}^{-1}$) were approximately the same. The results obtained show that in the period of 40 years (between the 20th and 60th year after afforestation) a considerable amount of C was bound in the afforested soils. However, C accumulation was significantly higher in the soils afforested by planting in bench terraces. This result indicates that the choice of a suitable afforestation method can create favourable conditions for C accumulation. It was confirmed that the change in land use can encourage C accumulation in biomass and soil (afforestation/reforestation) (Paul et al. 2002, Lal 2005, Vesterdal et al. 2007) and significantly reduce the C stock in soil (agriculture/tillage) (Post and Kwon 2000). In addition, afforestation methods requiring intensive soil preparation techniques for planting have an impact on the reduction of the bound C stock (Paul et al. 2002, Fonseca et al. 2014), similar to the tillage in agriculture (Post and Kwon 2000, Bono et al. 2008, Barbera et al. 2010). According to Fonseca et al. (2014), soil C accumulation generally decreases with an increase in the intensity of soil preparation for afforestation. However, moderate soil preparation techniques can increase soil C accumulation. The intensity of tillage directly affects the rates of organic matter decomposition and mineralization, which directly affects bound soil C stock (Lal and Kimble 1997). Mechanical soil preparation causes breakage of organomineral aggregates exposed to decomposition. Soil compaction is reduced and aeration is increased. The organic matter is mixed, which encourages its decomposition. However, proper selection of the technique of soil

preparation for afforestation can create optimal conditions for both plant growth and C binding (Boetang et al. 2012, Fonseca et al. 2014).

The analyses of the C accumulation in bench terraces, in soils between the bench terraces and the soil afforested by pit planting 60 years after afforestation shows a significantly higher ($80.34 \pm 27.4 \text{ Mg}\cdot\text{ha}^{-1}$) C stock in the bench terraces than in the soil between the bench terraces ($29.73 \pm 5.5 \text{ Mg}\cdot\text{ha}^{-1}$) and the soil afforested by pit planting ($24.63 \pm 12.3 \text{ Mg}\cdot\text{ha}^{-1}$), where preparations for planting involve low-intensity treatment without disturbances to the original soil structure. This result can be attributed to the impact of moderate soil preparation in the planting lines of the bench terraces. The method of afforestation by planting in bench terraces is applied in sites where vegetation, and particularly woody vegetation, can hardly be established spontaneously. When planting is performed on the flat part of a bench terrace, there is an inversion of soil layers, causing the placement of surface soil layers and the ones of the initially higher content of organic matter and nutrients into the deeper layers of the profile, in the zone of seedling root, while the pit is backfilled with the material from the deeper profile layers. The mixing of soil layers during soil preparation for planting improves the necessary conditions for the success and survival of seedlings (Fonseca et al. 2011), especially in the first few years after afforestation. Although the impact of the method can mainly be observed in the first few years after afforestation, according to Boetang et al. (2012), the impact of the afforestation method and mechanical preparation can affect long-term timber supply and consequently its C stock. In addition, soil stabilization in terms of erosion control, reduces the removal of organic matter and nutrients (Zhang et al. 2004, Cao et al. 2007, Wang et al. 2014), which may contribute to the C binding capacity of the soil.

The soil C accumulation rate between the 20th and 60th year after afforestation is statistically significantly higher in the afforestation by planting in bench terraces, reaching $1.75 \pm 0.6 \text{ Mg}\cdot\text{ha}^{-1}$, compared to the one in the afforestation by pit planting with $0.44 \pm 0.3 \text{ Mg}\cdot\text{ha}^{-1}$. The soil C accumulation rate in the planting lines of bench terraces also indicates that this way of soil preparation for planting may create favourable conditions for C accumulation.

CONCLUSION

The results of this research indicate that in harsh site conditions, like the ones prevailing in the Grdelica Gorge, the observed afforestation methods can affect C binding in afforested soils. Both methods stimulate soil C binding, whereas the method of afforestation by planting in bench terraces also increases the C binding capacity of the soil and its C accumulation rate. The difference is obvious in the soils of bench terrace planting lines, where the technique of soil preparation for planting involves mixing and inversion of soil layers.

Atmospheric C binding reduces the concentration of CO_2 in the atmosphere, which can have an effect on climate change mitigation. The restoration of forests by afforestation in degraded harsh sites, allows for the binding and accumulation of C, converting them into carbon sinks.

If a method encourages C accumulation, that can serve as a decision support tool for the selection of forest restoration methods in harsh site conditions, as well as for the provision of optimal functions and services of ecosystems. The application of an appropriate afforestation method in sites degraded or limited in production (inherent soil quality or other environmental factors) can directly and indirectly contribute to the improvement in the quality of the environment and people's lives in that area. Therefore, familiarity with the impact of different afforestation methods can contribute to the defining of the principles and recommendations of afforestation policy and future land management strategies.

Acknowledgements: *This paper was realized as a part of the project "Studying Climate Change and its Influence on the Environment: Impacts, Adaptation and Mitigation" (III43007), financed by the Ministry of Education and Science of the Republic of Serbia, within the framework of integrated and interdisciplinary research for the period 2011-2014.*

REFERENCES

- Andrejević M. (1959). Da li su gradoni novina za našu zemlju. Šumarstvo 5-6: 268-272.
- Barbera V., Poma I., Gristina L., Novara A., Egli M. (2012). Long-term cropping systems and tillage management effects on soil organic carbon stock and steady state level of C sequestration rates in a semiarid environment. *Land Degradation and Development* 23(1) : 82-91.
- Blanco H., Lal R. (2008). *Principles of Soil Conservation and Management*. Springer Science+Business Media B.V, Netherlands, pp. 620.
- Boetang J.O. Heineman J.L. Bedford L. Linnell Nemec A.F. McClarnon J. Powelson R.A. (2012). Twenty year site preparation effects on sub-boreal lodgepole pine performance. *New Forests* 43: 457-472.
- Bono A., Alvarez R., Buschiazzo D.E., Cantet R.J.C. (2008). Tillage effects on soil carbon balance in a semiarid agroecosystem. *Soil Science Society of America Journal* 72: 1140-1149.
- Bullock J.M., Aronson J., Newton A.C., Pywell R.F., Rey-Benayas J.M. (2011). Restoration of ecosystem services and biodiversity. conflicts and opportunities. *Trends in Ecology and Evolution* 26(10) : 541-549.
- Cao S., Chen L., Xu C., Liu Z. (2007). Impact of three soil types on afforestation in China's Loess Plateau. Growth and survival of six tree species and their effects on soil properties. *Landscape and urban planning* 83: 208-217.
- Ciccarese L., Mattsson A., Pettenella D. (2012). Ecosystem services from forest restoration. thinking ahead. *New Forests* 43: 543-560.
- Djorović M. (1969). Eksperimentalno utvrđivanje antierozionog dejstva – efekta gradona. Magistrski rad. Univerzitet u Beogradu - Šumarski fakultet, str. 27
- Djorović M., Isajev V., Kadović R. (2003). *Sistems of Afforestation and Grass Cover in Erosion Control*. Faculty of Forestry University of Banja Luka, Republic of Srpska, Bosnia and Hertzegovina, pp. 402.
- Fonseca F., de Figueiredo T., Martins A. (2011). Survival and early growth of mixed stands installed in a Mediterranean Region. Effects of site preparation intensity. *Forest ecology and management* 262: 1905-1912.
- Fonseca F., de Figueiredo T., Martins A. (2014). Carbon storage as affected by different site preparation techniques two years after mixed forest stand installation. *Forest systems* 23(1) : 84-92.

- Harrington C.A. (1999). Forests planted for ecosystem restoration or conservation. *New Forests* 17: 175-190.
- Holl K.D., Aide T.M. (2011). When and where to actively restore ecosystems? *Forest ecology and management* 261: 1558-1563.
- Hoover C.M., Birdsey R.A., Heath L.S., Stout S.L. (2000). How to estimate carbon sequestration on small forest tracts. *Journal of Forestry* 98(9): 13-19.
- Houghton R.A. (2005). Aboveground forest biomass and the global carbon balance. *Global Change Biology* 11. 945-958.
- IPCC (2003). Good Practice Guidance for Land Use, Land-Use Change and Forestry. IPCC, Institute for Global Environmental Strategies (IGES), pp. 593. [online] URL. http://www.ipcc-nggip.iges.or.jp/public/gpglulucf/gpglulucf_files/GPG_LULUCF_FULL.pdf
- ISO 11272 (1993). Soil quality – Determination of dry bulk density. International organization for standardization, Switzerland
- ISO 11277 (1998). Soil quality – Determination of particle size distribution in mineral soil material. Method by sieving and sedimentation. International organization for standardization, Switzerland.
- IUCN – International Union for Conservation of Nature (2004). Afforestation and Reforestation for Climate Change Mitigation. Potentials for Pan-European Action, Warsaw
- Jobbágy E.G., Jackson R.B. (2000). The vertical distribution of soil organic carbon and its relation to climate and vegetation. *Ecological Applications* 10(2): 423-436.
- Johnston M.H., Homann P.S., Engstrom J.K., Grigal D.F. (1996). Changes in ecosystem carbon storage over 40 years on an old-field/forest landscape in east-central Minnesota. *Forest Ecology and Management* 83: 17-26.
- Kachinskiy N.A. (1965). *Soil Physics, Part I*. Kolos Publishers. Moscow, pp. 132-139.
- Kostadinov S. (ed.) (1997). *Studija uređenja bujičnih tokova u gornjem delu sliva Južne Morave*. Šumarski fakultet Beograd.
- Lal R., Kimble J.M. (1997). Conservation tillage for carbon sequestration. *Nutrient Cycling in Agroecosystems* 49: 243-253.
- Lal R., Kimble J.M., Birdsey R.A., Heath L.S. (2003). Research and development priorities for carbon sequestration in forest soils. In: Kimble J.M., Heath L.S., Birdsey R.A., Lal R. (Eds.), *The Potential of U. S. Forest Soils to Sequester Carbon and Mitigate the Greenhouse Effect*. CRC Press, Boca Raton. 409-420.
- Lal R. (2005). Forest soils and carbon sequestration. *Forest Ecology and Management* 220. 242-258.
- Lorett W.R., Bolander B.E. (1982). *Tree Planting Guide (EC82-1738)*. Historical Materials from University of Nebraska
<http://digitalcommons.unl.edu/cgi/viewcontent.cgi?article=1832&context=extensionhist>
- Lujić R. (1960). „Lokalni toplotni faktor“ i njegova uloga u rasporedu vegetacije. Doktorska disertacija Šumarski fakultet Beograd. IP“Grafos“ Beograd. pp. 104
- Lujić R. (1973). *Šumske melioracije*. Udžbenik Univerzitet u Beogradu Šumarski fakultet, pp. 415.
- Millennium Ecosystem Assessment (2005). *Ecosystems and human well-being biodiversity Synthesis*, World Resource Institute.
- Moffat A.S. (1997). Resurgent forests can be greenhouse gas sponges. *Science* 277: 315-316.
- Niu X., Duiker S.W. (2006). Carbon sequestration potential by afforestation of marginal agricultural land in the Midwestern U. S. *Forest Ecology and Management* 223: 415-427.
- Oliet J.A., Jacobs D.F. (2012). Restoring forests. *advances in techniques and theory*. *New Forests* 43: 535-541.
- Økland T., Rydgen K., Økland R.H., Storaunet K.O., Rolstad J. (2003). Variation in environmental conditions, understory species number, abundance and composition among natural and managed *Picea abies* forest stands. *Forest Ecology and Management*, 177: 17-37.

- Pan Y., Birdsey R.A. Fang J. Houghton R. Kauppi P.E. Kurz W.A. Phillips O.L. Shvidenko A. Lewis S.L. Canadell J.G. Ciais P. Jackson R.B. Pacala S.W. McGuire A.D. Piao S. Rautiainen A. Sitch S. Hayes D. (2011). A large and persistent carbon sink in the world's forests. *Science* 333: 988-993.
- Panagopoulos T., Hatzistathis A. (1995). Early growth of *Pinus nigra* and *Robinia pseudoacacia* stands. contributions to soil genesis and landscape improvement on lignite spoils in Ptolemaida. *Landscape and Urban Planning* 32: 19-29.
- Paul K.I., Polglase P.J., Nyakuengama J.G., Khanna P.K. (2002). Change in soil carbon following afforestation. *Forest Ecology and Management* 168: 241-257.
- Post W.M. Kwon K.C. (2000). Soil carbon sequestration and land-use change. processes and potential. *Global Change Biology* 6: 217-328.
- Ratknjić M., Bilibajkić S., Braunović S., Miletić Z., Dražić D. (2011). Basic environmental conditions. In. "The selection of species for reforestation and amelioration in central Serbia" (Tomić Z, Rakonjac Lj, Isajev V eds). Institute of Forestry, Belgrade, Serbia, pp. 17-63.
- RHOS (1949-2011). Meteorološki godišnjak [Meteorological Annual Reports]. Republic Hydrometeorological Office of Serbia, Belgrade, Serbia.
- Richter D.D., Markewitz D., Trumbore, S.E. Wells, C.G. (1999). Rapid accumulation and turnover of soil carbon in re/establishing forest. *Nature* 400: 56-58.
- Saches J.D., Baillie J.E.M., Sutherland W.J., Armsworth P.R., Ash N., Beddington J., Blackburn T.M., Collen B., Gardiner B., Gaston K.J., Godfray, H.C.J., Green R.E., Harvey P.H., House B., Knapp S., Kumpel N.F., Macdonald D.W., Mace G.M., Mallet J., Matthews A., May R.M., Petchey O., Purvis A., Roe D., Safi K., Turner K., Walpole M., Watson R., Jones K.E. (2009). Biodiversity conservation and the Millennium Development Goals. *Science* 325: 1502-1503.
- Sheng T.C. (2002). Bench terrace design made simple, Proceedings of 12th ISCO Conference Vol. IV, Beijing (China), May 26-31, pp. 500 – 504.
- Soljanik I. (1952). Oprethodnoj obradi zemljišta za pošumljavanje. *Šumarski list* 10-11: 364-376.
- Soljanik I. (1955). Značaj oglednih polja kod veštačkog pošumljavanja. *Šumarstvo* 9: 551-563.
- Tanasijević Đ. (ed.) (1956). Pedološko-agrohemijske osobine i stanje erozije zemljišta Grdeličke klisure i Vranjske kotline. Institut za zemljište, Beograd, pp. 200.
- Tjurin I.V. (1965). Agrochemical methods of soil analysis. Nauka, Moscow
- Tomić Z. (2004). Šumska fitocenologija. Univerzitet u Beogradu – Šumarski fakultet, Beograd, pp. 261.
- Valladares F., Sánchez Gómez D. (2006). Ecophysiological traits associated with drought in Mediterranean tree seedlings. individual responses versus interspecific trends in eleven species. *Plant Biology* 8: 688-697.
- Velašević V. (1979). Research Project Report 1979 - Study of disorders of the ecosystem and degradation of the environment (in Serbian). University of Belgrade – Faculty of Forestry
- Vesterdal L., Rosenqvist L., Van Der Salm C., Hansen K., Groenenberg B.J., Johansson M.B. (2007). Carbon sequestration in soil and biomass from oak and Norway spruce chronosequences in Denmark, Sweden and the Netherlands. In. Environmental effects of afforestation in north-west Europe; Heil G.H. Muys B. Hansen K. (eds.); Springer, Dordrecht, Netherlands pp. 19-57.
- Wang D.H., Madley K.E. (2004). Land use model for carbon conservation across a midwestern USA landscape. *Landscape and urban planning* 69: 451-465.
- Wang G., Wu B., Zhang L., Jiang H., Xu Z. (2014). Role of soil erodibility in affecting available nitrogen and phosphorus losses under simulated rainfall. *Journal of Hydrology* 514: 180-191.
- Woodbury P.B., Smith J.E., Heath L.S. (2007). Carbon sequestration in the U.S. forest sector from 1990 to 2010. *Forest Ecology and Management* 241: 14-27.

PROCEEDINGS
International Conference **REFORESTATION CHALLENGES**
03-06 June 2015, Belgrade, Serbia

- WRB IUSS International Working Group (2006). World Reference Base for Soil Resources 2006 - A framework for international classification correlation and communication. World Soil Resources Reports 103, FAO, Rome, Italy.
- Vučičević D. (1995). Uređenje bujičnih tokova. Društvo bujičara Jugoslavije, Beograd, str. 441.
- Zhang B., Yang Y.-S., Zepp H. (2004). Effect of vegetation restoration on soil and water erosion and nutrient losses of a severely eroded clayey Plinthudult in southeastern China. *Catena* 57: 77-90.
- Zhang Y., Liu B.Y., Zhang Q.C., Xie Y. (2003). Effect of different vegetation types on soil erosion by water. *Acta Botanica Sinica* 45(10) : 1204-1209.

**MUTUAL RELATION OF RIVER WATER AND GROUNDWATER IN THE AREA OF
HYGROPHILIC FORESTS IN THE RAVNI SREM DOWNSTREAM OF SREMSKA
MITROVICA, SERBIA**

Nikić Zoran*, Ristić Ratko, Letić Ljubomir, Anđelić Milena, Mrvaljević Vaso

*Corresponding author: zoran.nikic@sfb.bg.ac.rs

Nikić Z. *, Ristić R., Letić Lj., Anđelić M., Mrvaljević V. (2015). Mutual relation of river water and groundwater in the area of hygrophilic forests in the Ravni Srem downstream of Sremska Mitrovica, Serbia. In: Ivetić V., Stanković D. (eds.) Proceedings: International conference Reforestation Challenges. 03-06 June 2015, Belgrade, Serbia. Reforesta. pp. 117-126.

Abstract: During the last century, the significant hydrological changes that have taken place in the Ravni Srem, as a result of anthropogenic activities, had an impact on the availability of water to the hygrophilic forests in this area. After the construction of the embankment for the defense of the flood waters from the Sava River and because of it, the absence of seasonal flooding, the hygrophilic forests have begun to dry individually and the process of their fragmentation has begun. The aim of the conducted researches was to assess the fluctuations of the groundwater levels in the case of Podlužje in the Ravni Srem, and for the purposes of the functional stability of the hygrophilic forests. The Sava River water level, fluctuation of groundwater levels and amounts of precipitation were analysed for the period 1992-2013 for the area of Podlužje. Input data were taken from the database of the Republic Hydrometeorological Service of Serbia. Groundwater level was analyzed for five individual piezometers and two batteries of piezometers, the Sava River water level was analyzed for three hydrological stations, and precipitation was analyzed for five rainfall stations. Calculated values are shown in the comparative diagrams by months and annual seasons, excluding the vegetational season. Conducted analyses show a significant dependence of the groundwater level fluctuations from the Sava River water level, as a result of direct hydraulic connection of surface water and groundwater. The obtained results can be in the function of forecast of groundwater levels in Podlužje and by that, contribute to more successful hygrophilic forests management in terms of planned redistribution of the area utilization.

Key words: hygrophilic forest, alluvial plain, groundwater; Sava, Ravni Srem.

INTRODUCTION

By the whole length of the southern border of the Srem, a spacious alluvial plain extends, which is parallel to the river flow of the Sava River. Mainly wetlands are represented in this area, where aquatic and coastal ecosystems with a very rich biodiversity have been formed. In previous centuries, in the area of the alluvial plain of the Sava River in the Srem, the hygrophilic forests were developing solely under the influence

of natural factors. Rainforests were growing on fertile soil and favourable water regime in the enormous area. Biogeocenotic balance ruled there which was the reflection of a good consistency of the relations between soil, climate, water, flora and fauna. Raising the embankment on the left bank of the Sava River, starting from 1904, following by its upgrading (increasing elevation embankment) in the period from 1946 to 1956 (Vujović and Rašteggorac 2002), leads to significant changes in the natural hydrological regime.

The large alluvial plain of the Sava River in Srem was singled out as a natural-economic entity and represents the working area and biological-material basis in forest production (Glavač 1962). On the territory of Serbia, the forests of the Ravni Srem are the best quality hygrophilic forests of highly productive forest stands and fall into technically the most valuable forests in the Balkans (Tomić 2004). Because of its hygrophilic characteristics, which are under the direct influence of different forms of some of the water resources (surface water and groundwater and precipitation), the hygrophilic forests are among the most endangered forests in Europe (Čater et al. 2008), and thus in Serbia as well. Drying of these forests is one of the major limiting factors of planning and forest management today (Letić et al. 2014). Intensification of this process leads to losses in production, breaking of the composition and stability of forest stands, inability to realize the goals and respect the prescribed measures of forest management, jeopardizing real management plans, and thus calls into question the viability of forest ecosystems potentials management in the Ravni Srem (Medarević et al. 2009).

In this paper, the analysis of mutual relations of surface water and groundwater was conducted for one part of the Ravni Srem, represented by the area of Podlužje. The aim of the research is the analysis of fluctuations of groundwater levels in Podlužje, but in terms of the functional stability of the hygrophilic forests.

MATERIAL AND METHOD

Of many influencing factors of the habitat in Podlužje, where the hygrophilic forests grow, the water regime or wetting (floodwaters, atmospheric precipitation and fluctuations in groundwater levels) is one of the most important. The area of Podlužje extends along the left bank of the Sava River, in the direction from Sremska Mitrovica (139 km from the confluence of the Sava and Danube) to Boljevci (34 km). The absolute height of the terrain near Sremska Mitrovica is in the altitude of about 79 m, and in Boljevci of about 75 m. For the area of Podlužje, the regime of fluctuation of the groundwater levels was analyzed based on data from five individual piezometers (Obrež, Hrtkovci, Prhovo, Sremska Mitrovica No. 67 and 85) and from two batteries of piezometers which have a total of nine piezometers (Nikinci and Lačarak), the regime of surface waters was analyzed from three hydrological stations on the Sava River, of which the measurement of the water level is done by the use of gauging rail at two stations (Šabac and Beljin), and in one the measurement of discharge and water level was done by limnigraph (Sremska Mitrovica), the amounts of precipitation were analyzed from five meteorological stations where two were from the category of synoptic/main climatological stations (Zemun, Sremska Mitrovica) and three from the category of precipitation (Boljevci, Hrtkovci, Brestač). All pre-specified observation objects (for monitoring of groundwater levels,

water levels on the Sava River and precipitation) are part of the observation network of the Republic Hydrometeorological Service of Serbia (RHMSS), and measurements are taken at precisely determined terms which are defined by their rule book. For the purposes of here presented results, the measured values for all analyzed parameters were taken from the database from the site of the RHMSS and from published hydrological and meteorological yearbooks of the RHMSS. General data about the measuring stations were also taken from the site of the RHMSS, and Table 1 shows the basic data about the piezometers.

Table 1. Data on groundwater observation stations in Podlužje in the Ravni Srem (site of the RHMSS)

No.	Name- designation of piezometer	Cat. of piezom. *	Elevatio n "0" of piezom. (m a.s.l.)	Length of construc. (m)	Latitude	Longitude	Interval of observ (day)
1	Obrež 137	P	78,99	7,55	44°44'15"	19°58'30"	3
2	Nikinci NI-1	B	80,45	16,40	44°50'48"	19°50'38"	6
3	Nikinci NI-1/1	B	80,47	8,70	44°50'48"	19°50'38"	3
4	Nikinci NI-1/2	B	80,49	5,20	44°50'48"	19°50'38"	3
5	Nikinci NI-1/D	B	80,47	24,60	44°50'48"	19°50'38"	6
6	Sr. Mitrovica 67	P	85,74	8,34	44°59'52"	19°40'08"	2
7	Sr. Mitrovica 85	P	81,57	8,43	44°57'19"	19°40'22"	2
8	Hrtkovci 142	P	80,80	9,89	44°52'46"	19°46'32"	3
9	Lačarak L-1	B	81,47	10,70	45°00'33"	19°33'37"	6
10	Lačarak L-1/1	B	81,68	6,20	45°00'34"	19°33'37"	6
11	Lačarak L-1/2	B	81,75	4,20	45°00'34"	19°33'37"	6
12	Lačarak L-1/D	B	81,56	42,20	45°00'33"	19°33'37"	6
13	Lačarak L-1/d	B	81,70	26,20	45°00'33"	19°33'37"	6
14	Prhovo 145	P	77,67	6,40	44°52'59"	20°00'20"	3

*P-individual piezometer; B-battery of piezometers

Calculation of the values of the analyzed parameters (groundwater level, water level of the Sava River and precipitation) was performed for the period 1992-2013. On the basis of daily values, the average monthly values for each year of the analyzed period were calculated, and then the average monthly values for the entire analyzed time period. In addition to these values, the analysis was conducted and the average perennial values for the annual seasons were shown for all analyzed parameters for the entire analyzed period. For the groundwater, the analysis was conducted separately for "deeper" (subartesian) aquifer on four piezometers and for "shallower" (phreatic) aquifer on ten piezometers. In the case where in the database of the RHMSS, there was no entered value for a certain term for the analyzed parameter, which was taken into account at the conducted calculations. For the period of observation, a comparative analysis of the water level of the Sava River, groundwater levels and precipitation was done by months for each year, for four annual seasons (winter, spring, summer and autumn) for the area of Podlužje and summarized by months and seasons for the entire analyzed period.

Area of research and its specific features

The whole territory of the Srem is a part of a unique Pannonian sedimentary basin in which tectonic faulting and lowering the former Pannonian land did not include only the massif of Fruška Gora. In the formed tectonic depression, the semi-cohesive and non-cohesive rock masses were deposited during the Neogene, when it came to shallowing of the entire basin and the allocation of a number of shallow lakes after the Levantine-Paludine stage (Dimitrijević et al. 1983). The formation of the recent relief began in the second half of the Pleistocene, when it came to the formation of the Danube River (by which the waters from the Pannonian area were flowing away), drying of the great lakes and the accumulation of eolian material. Changes of the climatic conditions in the glacial and interglacial periods have led to the alternation of the aeolian accumulation and fluvial erosion and accumulation.

In the area of Srem, in the alluvial plain of the Sava River, the powerful alluvial aquifer that extends from the left bank of the Sava River in the south to the loess terrace in the north was formed. In this area, the general hydrogeological conditions have been defined by the large thickness of the Neogene sediments which constitute the floor (basis) of the Quaternary formations. Over the Neogene formations, during the Quaternary, the coarse gravel and sandy sediments were firstly deposited, and then in their overlying, predominantly clay-muddy formations. Powerful alluvial aquifer in the Ravni Srem represents a natural two-layer porous environment (Nikić, 2003b; 2004). Recharge of the alluvial aquifer, that is, the main water movement takes place on the relation between the Sava River-aquifer, and the infiltration from precipitation in places where the aquifer is open toward the surface of the terrain and the flowing in of the groundwater from other aquifers. Alluvial aquifer is of a compact type and depending on the local geological relations; a semi-open or open type of the hydrogeological structure appears. In a semi-open hydrogeological structure, a subartesian aquifer was formed where the level of the aquifer put pressure on the overlying, a less permeable layer, while in the open hydrogeological structure a phreatic groundwater was formed that had a free level which fluctuated depending on the mode of recharge and drainage of the aquifer. The lower, gravel-sandy layer within the alluvial aquifer has good permeability and is usually thicker than the superficial, less permeable and thinner clay-muddy layer (Milojević 1959). The movement of the groundwater in the lower gravel-sandy layer at a semi-open hydrogeological structure takes place in conditions of the groundwater flow under pressure and it is horizontal (the vertical component of velocity has been neglected), while in the open hydrogeological structure, the filtration of the groundwater can be directed upwards and downwards (Nikić et al. 2010). The movement of the groundwater occurs due to differences of the piezometric levels and the existence of the hydraulic gradient. Drainage of this aquifer, depending on hydrological conditions, is done towards the Sava riverbed, by evapotranspiration and exploitation over the water intake facilities (dug, drilled and Ranney wells).

In the study area, a continental type of climate is represented, which according to Rakićević (1980) is characterized by the annual range of temperature of $\leq 23^{\circ}\text{C}$, and in the summer half of the year over 50% of the total precipitation is excreted. In general, the climate in this area is the result of distance from the sea (Adriatic) and openness to the

influence of continental air masses that circulate through the Pannonian Plain from Eastern and Northern Europe (Rakićević 1976).

RESULTS AND DISCUSSION

In favorable hydrogeological and hydrological conditions, groundwater and river water can make different forms of a hydraulic connection (Nikić 2003a). Consideration of mutual relations of groundwater and river water is a very demanding task. It reflects in the interpretation of the regime of groundwater fluctuations in a certain area depending on a number of natural and anthropogenic factors. In the area of Podlužje in the Ravni Srem, the fluctuation of the groundwater levels was discussed at the regional level as a result of geological and hydrogeological conditions within the alluvial formations, hydrological condition of the Sava River and amount of precipitation.

Taking into account the groundwater and surface water as benchmark elements, according to the basic types of mutual relations of groundwater and river water, on the basis of the conducted researches in the area of Podlužje, the existence of two main types of relations has been established: 1) direct hydraulic connection of aquifers of a free level and the river, and 2) direct hydraulic connection of subartesian aquifers and the river (Nikić 2003a). Within these two basic types of mutual relations, the groups of relations have been represented. This speaks of the complexity of the water regime in the area of Podlužje.

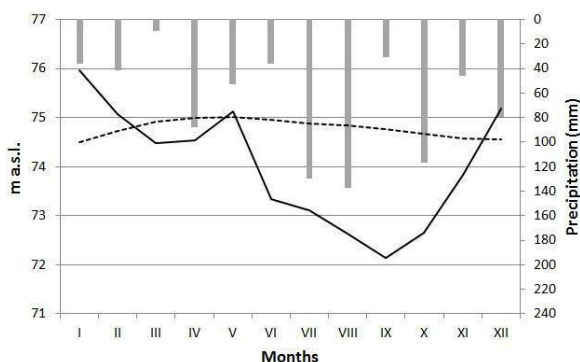

Figure 1. Comparative diagram of the average monthly values of the fluctuation of the groundwater levels of the shallower aquifer in the piezometer O-137 in Obrež, the water level of the Sava River in the hydrologic station of Beljin and the amount of precipitation in the synoptic station of Surčin for 1997. Legend: — average monthly water level of the Sava River; ---- average monthly groundwater level; || - monthly amount of precipitation.

In the area of Podlužje, a comparative analysis of mutual relations of the surface water of the Sava River and the groundwater of the alluvial aquifer was conducted in two water-bearing zones: 1) shallower, phreatic aquifer and, 2) deeper, subartesian aquifer. For example of the overview of a typical mutual relation of the surface water of the Sava River and the shallower aquifer (phreatic), the piezometer in Obrež (O-137) and the water

level of the Sava River in the profile of Beljin were selected for the year of 1997 (Figure 1). The graph clearly shows the dependence of the groundwater levels from the Sava River water level. It is noted that the maximum groundwater level is reached after a prolonged period of the high water level of the Sava River during the spring season. During the summer and autumn periods when the water level of the Sava River drops all the time and reaches a minimum, the level of groundwater of the shallower aquifer is also of a declining trend, but the height of the lowering of the groundwater levels is much lower.

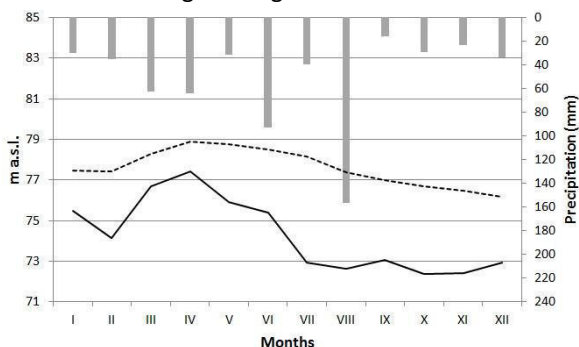

Figure 2. Comparative diagram of the average monthly values of the fluctuation of the groundwater levels of the deeper aquifer in the piezometer NI-1 in Nikinci, the water level of the Sava River in the hydrologic station of Šabac and the amount of precipitation in the synoptic station of Sremska Mitrovica for 2006. *Legend:* — average monthly water level of the Sava River; ---- average monthly groundwater level; || - monthly amount of precipitation.

The difference between the maximum and minimum monthly average water level of the Sava River was nearly 4 m in 1997, and the groundwater level only of about 0.5 m. Taking into account the relatively modest amounts of monthly precipitation sums in this area, a realistic conclusion is that the shallower aquifer predominantly reacts to the hydrology condition of the Sava River. However, this reaction is very slow. These points to significant retention opportunities of the water bearing environment within which the shallower aquifer was formed. This aspect is of great importance for the hygrophilic forests in the area of Podlužje. Based on display in Figure 1 it can be concluded that in the period of high water level of the Sava River in winter and shortly in spring, the river water recharges the shallower aquifer, and that in the period of low water level of the Sava River, the groundwater of the shallower aquifer recharges the Sava River discharge.

For indicating example of the overview of a mutual relation of the Sava River and the deeper aquifer (subartesian), the piezometer NI-1 in Nikinci and the water level of the Sava River in the profile of Šabac were selected for the year of 2006 (Figure 2). In this case, a very strong dependence of the fluctuation of the groundwater levels of the deeper aquifer from the Sava River water level is present. When the water level of the Sava River increases, the groundwater level increases too, and when the water level of the Sava River decreases, the groundwater level of the deeper aquifer decreases as well. It is obvious that the line of the groundwater levels follows the water level of the Sava River, but including the mitigating of the "peaks" and the existence of a certain period of time of the appearance of the maximum groundwater level in relation to the maximum water level of

the Sava River. And for the deeper aquifer we have a more pronounced fluctuation of the Sava River water level, which is about 4.1 m, and for the groundwater, the fluctuation between the maximum average monthly and the minimum average monthly level is about 2.4 m. For the deeper aquifer in Podlužje, the influence of precipitation on the fluctuation of the groundwater levels does not exist. However, expressed in absolute elevations, the average monthly groundwater level of the deeper aquifer was higher than the average monthly water level of the Sava River during the whole year of 2006. It is a realistic assumption that this is the result of complex local hydrogeological conditions. The level of the deeper aquifer and the water level of the Sava River, shown in Figure 2, clearly points that the deeper aquifer continuously charges the Sava River discharge. This leads to its very respectable water potential. In addition, in terms of the hygrophilic forests in the area of Podlužje, the significance of the subartesian aquifer is reflected in the fact that due to the existence of the hydrostatic pressure (which acts on the seam less permeable layer), this water contributes to the recharge of the shallower aquifer.

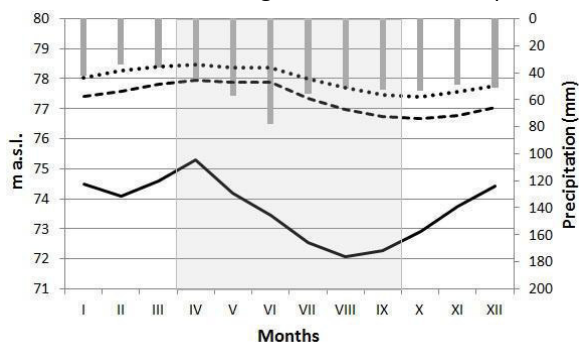

Figure 3. For the area of Podlužje, a comparative diagram of the average monthly fluctuations of the levels of shallower and deeper waters of the alluvial aquifer, the water level of the Sava River and precipitation for the period 1992-2013. Legend: — average monthly water level of the Sava River; --- average monthly level of deeper groundwater; ••• - average monthly level of shallower water; || - average monthly amount of precipitation; grey area - vegetation period.

For the period 1992-2013, for the area of Podlužje, Figure 3 shows the average monthly level of the shallow groundwater (phreatic) and deep (subartesian) aquifer, the water level of the Sava River and precipitation. And for this 21-year analyzed period, as well as for the previous one year periods, there is an obvious correlation of the surface water and the groundwater, that is, the existence of a direct hydraulic connection between the alluvial aquifer and the water of the Sava River. This point to the significance of the groundwater in terms of its use for purposes of the hygrophilic forests during the dry season. Thanks to the existence of a hydraulic connection between the deeper and shallower water through less permeable layers within the alluvial formations of the Sava River, these waters in certain hydrogeological conditions may be available to the hygrophilic forests during the vegetational season.

Figure 4 presents a mutual relation between groundwater and river water by the annual seasons for the period 1992-2013 in the area of Podlužje. And this graph expresses a mutual dependence of surface water and groundwater. During the winter season and a

half of the spring season, a higher level of surface water and groundwater is noticeable, and the trend of decrease and the lower water levels during the second half of spring, summer and autumn. However, it is important that groundwater is of a milder and much slower trend of a decrease in levels during the recession period. Therefore, groundwater gains in importance precisely when water is most needed for the vegetation during the dry season.

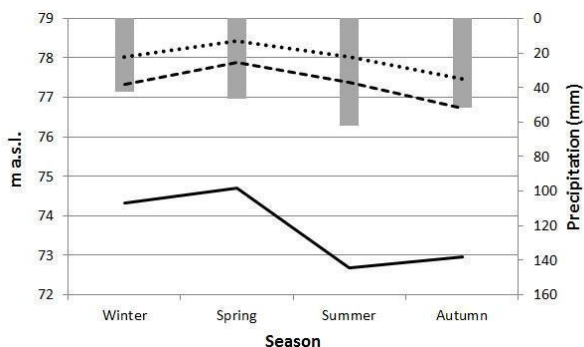

Figure 4. For the area of Podlužje, a comparative diagram of the average seasonal fluctuations of the levels of shallower and deeper waters of the alluvial aquifer, the water level of the Sava River and precipitation for the period 1992-2013. Legend: — average seasonal water level of the Sava River; -- -- average seasonal level of deeper groundwater; •••• - average seasonal level of shallower water; || - average monthly amount of precipitation.

On the basis of the data used in this study and the obtained results, it cannot be said with certainty what will be the future of the hygrophilic forests in the area of Podlužje. Taking into account that the groundwater of the alluvial aquifer from this area is used more intensively (and in the future will be used even more), and for other purposes (water supply, irrigation), the need and the necessity of allocating priorities for its use will come to the fore. This upcoming issue should be particularly seen in the light of climate change.

The obtained research results indicate that groundwater in favorable hydrological conditions may contribute to the improvement of the water regime and thus improve the functional stability of the hygrophilic forests in the area of Podlužje in the Ravni Srem. In this way, it can be actively contributed to the survival and progress of the hygrophilic forests in these areas.

CONCLUSION

Favourable natural conditions and a wealth of different types of water resources (surface water and groundwater and precipitation) have enabled the emergence of high-quality hygrophilic forests in Podlužje, that is, in the whole area of the Ravni Srem. The construction of the embankment for the defense of the flood waters of the Sava River and other melioration facilities, have led to a significant disruption of the hydrological situation in this area.

Thanks to the favorable hydrological and hydrogeological conditions, a powerful alluvial aquifer in the alluvial formations of the Sava River exists. Waters of this aquifer are in a hydraulic connection with waters of the Sava River and because of that, there is a certain mutual connection. For shallower, phreatic aquifer which level is closer to the surface of the terrain, a small fluctuation of the groundwater level is characterized. Due to relatively low depth of the level from the surface of the terrain, water is available to the root system of the hygrophilic forests in the favorable hydrological conditions. For the subartesian aquifer, which is slightly deeper than the surface of the terrain, a considerable quantitative abundance of groundwater and the existence of hydrostatic pressure are characterized and hence it contributes to recharge the shallower aquifer through less permeable layers, while the atmospheric precipitation have no direct impact on the fluctuation of levels of this aquifer.

Obtained dependencies can be in function of prognosis of the groundwater levels in parts of the alluvial plain of the Sava River, which is defended from the flood waters. This contributes to the successful management of hygrophilic forests in terms of allocation of the area on which, depending on the local hydrogeological conditions, can be possible to achieve, naturally or through hydromeliorational facilities, better availability of groundwater for the purpose of functional stability of these forests in the explored area.

Available data on the dynamics of groundwater and its amounts are general, but with a strong positive signal that groundwater of the alluvial aquifer may be in function of the hygrophilic forests and successful forestry production both in the present and in the future. Therefore, special attention to the area that is under the hygrophilic forests in Podlužje and even throughout the Ravni Srem should be given to the establishment of a functional observation network of groundwater stations.

Acknowledgments: *This paper was carried out in the framework of the scientific research project from the Research Programme in the Field of Technological Development No. 37008, funded by the Republic of Serbia - Ministry of Science and Technological Development, for the research cycle in the period 2011-2015.*

REFERENCES

- Čater M., Bobinac M., Levanič T., Simončič P. (2008). Water Status, Nutrients and Radial Increment of Penduculate Oak (*Quercus robur* L.) in Northern Serbia and Comparison with Selected Sites in Slovenia. Zbornik gozdarstva in lesarstva, No. 87. Pg. 135 – 144.
- Dimitrijević M., Dragić D., Karamata S., Petrović B., Sikošek B., Veselinović D. (1983). Reviewer for BGM SFRY 1: 100 000, Journal Šabac. Federal Geological Institute. Belgrade.
- Glavač V. (1962). Basic Phytocenological Division of the Lowland Forests in the Posavina. Forestry Journal, No. 9-10, p. 317-329. Faculty of Forestry, University of Zagreb. Zagreb.
- Letić Lj., Savić R., Nikolić V., Lozijanin R. (2014). Influence of the Melioration Works on the Condition of the Pedunculate Oak Forests in the Ravni Srem. Forestry, No. 3-4, p. 117-129. Belgrade.
- Milojević N. (1959). Hydrogeological Opportunities of the Srem. Geology Annals of the Balkan Peninsula, Book 26, Belgrade.
- Medarević M., Banković S., Cvetković Dj., Abjanović Z. (2009). Problems of Drying of the Forests in the Upper Srem. Forestry, no. 3-4, p. 61 - 73. Belgrade.

PROCEEDINGS
International Conference **REFORESTATION CHALLENGES**
03-06 June 2015, Belgrade, Serbia

- Nikić Z. (2003a). Hydrogeological Analysis of the Formation and Regionalization of the Low Water. Andrejević Foundation. Belgrade.
- Nikić Z. (2003b). Condition and Abilities to Provide Quality Water for the Needs of the Hunting Ground "Crni lug". 32nd Conference "Water 2003". Conference Proceedings, pp. 373-376. Zlatibor.
- Nikić Z. (2004). Providing Water for the Hunting Grounds "Karkuša". 33rd Conference "Water 2004". Conference Proceedings, pp. 525-528. Zlatibor.
- Nikić Z., Letić Lj., Nikolić F., Filipović V. (2010). Calculation Procedure for the Underground Water Level Regime at the Site of Pedunculate Oak Forests in the Ravni Srem. Faculty of Forestry, No. 101, p. 125-138. Belgrade.
- Rakićević T. (1976). Climate Characteristic of Eastern Serbia. Collection of Papers of the "Geographical Institute Jovan Cvijić", Book 28, p. 41-67. Belgrade.
- Rakićević T. (1980). Climatic Zoning of the SR of Serbia. Collection of Papers of the "Geographical Institute, Faculty of Mathematics and Natural Sciences", Vol. 27, p. 29-42. Belgrade.
- Tomić Z. (2004). Forestry Phytocenology. University of Belgrade, Faculty of Forestry. Belgrade.
- Vujović M., Raštegorec Z. (2002). Monograph: Cooperative for Draining of the Southeastern Srem 1902-2002. Water Management Enterprise "Galovica". Zemun.
- www.hidmet.gov.rs. (1992-2013). Database of the RHMSS. Belgrade.

A CONTRIBUTION TO THE HUNGARIAN AND TURKEY OAK SITE DEFINING IN CENTRAL SERBIA

Krstić Milun, Tomašević Veljović Jasmina, Kanjevac Branko

Krstić M., Tomašević Veljović J., Kanjevac B. (2015). A contribution to the Hungarian and Turkey oak site defining in central Serbia. In: Ivetić V., Stanković D. (eds.) Proceedings: International conference Reforestation Challenges. 03-06 June 2015, Belgrade, Serbia. Reforesta. pp. 127-133.

Abstract: The study was carried out in the Hungarian and Turkey oak forests (*Quercetum frainetto - cerris typicum Rud. 49*), on the mountain Jastrebac, in the region central Serbia. Altogether 31 stands were monitored in mixed forests of this species, which occur in the altitudinal belt between 400 and 800 m a.s.l. By applied method of defining the local heat potential (Lujčić 1960), modified by Ratknić et al. (2001) and Krstić (2004, 2008), which represents potentially possibility of soil heating without vegetation, were determined a scale of 162 possible combinations of local heat potential, which explains more precisely the dependence of Hungarian and Turkey oak forests on the topographic conditions.

By applying the weighted values of the thermal co-ordinates of aspect and slope (E) for each altitudinal belt of 100 m (thermal co-ordinate of altitude – V), it was concluded that pure stands have the narrow ecological range. Hungarian and Turkey oak stands occur at the sites with 9 combinations of thermal co-ordinates E;V = 6;13 to 8;14. The percentage of this stands is highest (51.6%) at the sites with the thermal co-ordinate E=7, i.e. on the terrains with southern aspect and terrains slope up to 7°, southeastern and southwestern aspect and terrains with inclination of 53-60°, or transitional - eastern and western aspect with terrains slope up to 25°. In terms of height the highest percentage is in altitudes between 600 and 700 m a.s.l. (35.5%), V=12.

By using the local heat potential of a region, it can be identified which sites, i.e. which combinations of exposure, slope and altitude belong to the particular tree species. Consequently, a more reliable selection of tree species can be done for the bio-reclamation of barrens and other deforested terrains.

Key words: topographic factors, local heat potential, central Serbia, distribution of Hungarian and Turkey oak forests.

INTRODUCTION

Topographic factors are very significant to the occurrence and survival of vegetation in a region, because in the conditions of the pronounced relief, with frequent and sudden changes of aspect or slope, the environmental conditions change in a relatively small space. They modify the other ecological factors, primarily the climate, so they become dominant in the spatial distribution of forests of the specific tree species. Aspect and topographic position are important determinants of local temperature conditions (Kimmins 2004). According to (Ohsawa 1990) altitudes and temperature conditions at the forest limit, latitudinal shift in the temperature limit for correlation of

forest, zonation along latitudinal gradients and mountain vegetation. Altitudinal change in temperatures has a major effect on the distribution of plants and vegetation along an elevational gradient in mountainous areas (Tang and Fang 2006).

According to Allen et al. (2006) similar thematic was treated in many researches: monthly mean solar radiation for horizontal and inclined surfaces, global daily radiation on any surface, estimating solar radiation on slopes of arbitrary aspect, and modeling solar radiation in steeply sloping terrain. However, there is few data about influence of those parameters on distribution of forests of certain tree species.

The significance of topographic factors and their undoubtful relationship with the alternation of the vegetation types was reported by Leibundgut (1951), Bunuševac (1951), Lujčić (1960), Kolić (1972), Cogbill and White (1991), Krstić (2000), Krstić et al. (2001, 2002), Smailagić et al. (2002), Kimmins (2004), Tang and Fang (2006), Hayes et al. (2007), etc.

Dealing with the effect of topographic factors on the heating up of the treeless area at a locality and the significance of soil temperature on the distribution of individual forest communities, Lujčić (1960) introduced the term local heat potential. The degree of heat which characterises the combination of exposure and slope was named their thermal co-ordinate denoted by E, and the degree of heat of a specific altitude was named their thermal co-ordinate V, and each was enumerated from 1 to 9. The potential of a concrete locality heating up to the altitude of 1800 m can be expressed by 81 combinations of the above numbers. The approximate idea on the potential of heating of any locality can be obtained by the comparison of the local thermal factors in a region. The significance of such research was indicated by Krstić (2003, 2004, 2006), Krstić et al. (2001, 2002, 2009), Smailagić et al. (2002), etc., and it was implemented in the papers by Ratknić et al. (2001) and Krstić (2004, 2008).

Based on the above, the aim of this paper is to define more closely, in the framework of other ecological factors, the effect of the topographic factors on the occurrence and distribution of Hungarian and Turkey oak forests in central Serbia, i.e. to express more precisely their correlation.

MATERIAL AND METHOD

The study was performed in the Jastrebac region in central Serbia. The latitude of the study region is between 43°19' and 43°24' N, and longitude between 21°23' and 21°32'. As in the study region the difference in latitude is lower than 1°, according to Lujčić (1960) and Krstić (2004, 2008), the deviations in the intensity of radiation are very low, so the degree of the terrain heating up will not be significantly affected.

The study was carried out in typical Hungarian and Turkey oak forests (*Quercetum frainetto - cerris typicum* Rud. 49) in the Jastrebac region in central Serbia. All forests in this study are treated without the definition of plant communities, origin, age, development phase, stand structure, and without the presence of species. To identify the dependence of the occurrence and distribution of thus classified stands on the topographic factor, the data were collected on the altitude, exposure, slope and terrain configuration. Altogether 31 stands were monitored (Table 1).

The data processing and the analysis of results are performed according to Lujčić's method (1960), modified by Krstić (2004, 2008) by defining the local heat potential. The thermal co-ordinates of exposure (aspect) and slope, and the co-ordinates of the altitude are determined for each study stand. The data are grouped according to the local heat potential per altitudes in the belts of 100 m. For the more precise definition of the dependence of stands on topographic factors, the weighted mean value of thermal co-ordinates of exposure and slope (E) were calculated for each altitudinal belt of 100 m, i.e. thermal co-ordinate (V).

Table 1. Distribution of the study stands by altitudes

Altitude	Co-ordinate V	Stand number	
		N	%
401-500	14	8	25.8
501-600	13	10	32.3
601-700	12	11	35.5
701-800	11	2	6.5
Total		31	100

The co-ordinates of exposure and slope (E=1-9) are retained and the co-ordinate of altitude is amended. Instead of Lujčić's nine-degree scale (V=1-9 - one thermal degree = 200 m), the eighteen-degree scale (V=1-18) was applied, where one thermal degree signifies 100 m (Krstić 2004, 2006, 2008; Ratknić et al. 2001). This resulted in a more sensitive scale of 162 possible combinations of the local heat potential, which explains more precisely the dependence this oak stands on the topographic conditions, because altitudinal change in temperatures has a major effect on the distribution of plants and vegetation along an elevational gradient in mountainous areas, and mean air temperatures generally colder at the higher elevation site than the lower site (Bunuševac 1951, Kimmins 2004, Krstić 2005, 2007, Krstić et al. 2005, Tang and Fang 2006, Friedland et al. 2003, Smailagić et al. 2002). Soil temperatures compared to air temperatures suggest that they were significantly damped relative to air temperatures.

RESULTS AND DISCUSSION

Aspect and topographic position are important determinants of local temperature conditions. According to Kimmins (2004) and Wang et al. (2004) both latitude and altitude influence the radiation budget. Zonation along latitudinal gradients and mountain vegetation as the forest limit depend on their latitude - differ with the latitude in which mountain is located (Ohsawa 1990). The nature of site for afforestation is criteria decisive for the choice of nursery stock production technology (Isajev et al. 2000).

Due to the change of the climate factors, growing season, floristic and the forest limit with the change of the altitude and the difference between the northern and southern slopes was more pronounced at lower elevations and less pronounced at higher

elevations (Bunuševac 1951, Tang and Fang 2006, Ohsawa 1990, Kimmins 2004, Fang and Yoda 1988, etc.).

By the applied method of defining the local heat potential, which represents possibility of soil heating without vegetation, a scale of 162 possible combinations of local heat potential was obtained, which explains more precisely the dependence stands on the topographic conditions. The significance of such research was indicated by Krstic (2003, 2004, 2006), Krstić et al. (2001, 2002), Smailagić et al. (2002), etc., and it was implemented in the papers by Ratknić et al. (2001), Krstić (2004, 2008), Krstić et al. (2009).

By stating the results of numerous measurements and researches of solar radiation, light, temperature and evaporation at different exposures and slopes in Serbia by the Bunuševac (1951), Soljanik (1960), Lujčić (1960), Kolić (1972), Krstić (1986, 2004, 2008), Krstić et al. (2001), Ratknić and Toković (2001), Smailagić et al. (2002) they emphasise the following:

- the warmest combination of exposure and slope in our region is the south exposure with the slope of 40-50°,
- the difference between the warmest and the coolest point in a region depends on the combination of the terrain configuration elements,
- the thermal difference between south and north exposures with gentle slopes is insignificant, so the division into warm and cool exposures is unacceptable if the slope is not also taken into account, which means that there is only a “warm and cool combination” of exposures and slopes.

Distribution of stands based on the local heat potential

The distribution of Hungarian and Turkey oak stands in the study region per altitudes shown in Table 1, and percentage of stands, based on the local heat potential (E;V), shown in Table 2 and 3.

Based on the mean values of the thermal co-ordinate of aspect and slope (E), we can see that those stands are absent in the combinations of the thermal co-ordinates which represent the cooler sites, e.g. the thermal co-ordinate E=1-5 (Table 2 and 3). These are the north exposures, and northeast and northwest exposures with the slope above 21°. They are also absent in the warmest sites with thermal co-ordinate E=9, i.e. the terrains of the south exposures, slope 28-47°. This is consistent with Richardson et al., (2004) that the microclimatology of mountain landscapes is dependent on latitude, continentality and topography.

In the studied region mixed Hungarian and Turkey oak stands ranged within the altitudinal belt 400-800 m a.s.l. The analysis of the above data on the percentage of this oak stands in the study region is presented based on the local heat potential in Table 2. They occur at the sites with thermal co-ordinates E = 6, 7 and 8. According to Lujčić (1960), in Hungarian and Turkey oak forests in southeast Serbia, the value of the thermal co-ordinate E amounts to 6 and 9. Pure sessile oak stands, according to Krstić (2008) in the region of east Serbia, ranged between thermal co-ordinate E=3 and 9, in Župa region between 5 and 8 (Krstić et al, 2009). In the region of Grdelička Klisura, between 6 and 9 (Lujčić 1960), while in the region of west Serbia, between 4 and 9 (Ratknić et al. 2001).

PROCEEDINGS
International Conference **REFORESTATION CHALLENGES**
03-06 June 2015, Belgrade, Serbia

Table 2. Percentage Hungarian and Turkey stands, based on the local heat potential (E.V)

Altitude	401-500	501-600	601-700	701-800	801-900	Total
Co-ordinate V	14	13	12	11	10	%
6		3.2				3.2
Co-ordinate E	22.6	16.1	9.7	3.2		51.6
8	3.2	12.9	25.8	3.2		45.2
Total	25.8	32.2	35.5	6.4		100

Thermal co-ordinate E was multiplied with the number of stands for each thermal co-ordinate in the altitudinal belt of the 100 m. Those values are cumulated, and total cumulated values are divided is with total number of stands in the concrete altitudinal belt of the 100m. Average mean value of thermal co-ordinate E was derived that way, and shown in the Table 3. We can see that average value of the thermal co-ordinate E is 7.4.

According to Lujčić (1960), in this forests in southeast Serbia, the average value of the thermal co-ordinate E amounts to 6.85. In the region of northeast Serbia the occurrence of mixed forests of xero-mesophilous sessile oak and xerophilous Turkey oak, i.e. their distribution on the increasingly warmer combinations of exposure and slope 7.0 to 8.0. In the sessile oak forests in southeast Serbia average mean values of the thermal co-ordinate E amounts to 6.85 (Lujčić, 1960), of northeast Serbia in pure sessile oak stands is 7.42 (Krstić 2008), in Župa region is 7.41 (Krstić et al. 2010). The above data indicate clearly the xerothermisation of the sites with the higher value of the co-ordinate E.

Table 3. Mean value of thermal co-ordinate of exposure and slope (E) per altitudinal zones.

Altitude	401-500	501-600	601-700	701-800	801-900	Average
Co-ordinate V	14	13	12	11	10	
E	7.1	7.3	7.7	7.5		7.4

The data showed in Table 4 indicates that mixed Hungarian and Turkey oak stands in Jastrebac region occur at the sites with 9 combinations of thermal co-ordinates E;V = between 6;13 and 8;14. The percentage of this stands is highest (51.6%) at the sites with the thermal co-ordinate E = 7, i.e. on the terrains with southern aspect and terrains slope up to 7°, southeastern and southwestern aspect and terrains inclination of 53-60°, or transitional - eastern and western aspect with terrains slope up to 25°. In terms of height the highest percentage is in altitudes between 600 and 700 m a.s.l. (35.5%), i.e. thermal co-ordinate V=12. That indicate that the mixed Hungarian and Turkey oak stands are most located at the sites of thermal co-ordinates E;V=7;12.

Table 4. Distribution of oak by sites in the Jastrebac region in Serbia.

Altit. (m)	Thermal co-ordinates (E;V)					
801-900	4;10	5;10	6;10	7;10	8;10	9;10
701-800	4;11	5;11	6;11	7;11	8;11	9;11
601-700	4;12	5;12	6;12	7;12	8;12	9;12
501-600	4;13	5;13	6;13	7;13	8;13	9;13
401-500	4;14	5;14	6;14	7;14	8;14	9;14

Hungarian and Turkey oak site

By using the local heat potential of a region, it can be identified which sites, i.e. which combinations of exposure, slope and altitude belong to the particular tree species. Consequently, a more reliable selection of tree species can be done for the bio-reclamation of barrens and other deforested terrains.

CONCLUSIONS

Topographic factors, for a specific altitude and the combination of aspect and slope, characterise the potential heating up of the soil of each locality. A closer definition of the effect of topographic factors on the occurrence of mixed Hungarian and Turkey oak forests distribution in Jastrebac region in central Serbia, i.e. a more precise account of their dependence, was accomplished by the determination of the local heat potential and the local thermal factor.

Mixed Hungarian and Turkey oak stands in this region occur at the sites with 9 combinations of thermal co-ordinates E;V = 6;13 to 8;14. The percentage of this stands is highest (51,6%) at the sites with the thermal co-ordinate E=7, i.e. on the terrains with southern aspect and terrains slope up to 7°, southeastern and southwestern aspect and terrains inclination of 53-60°, or transitional - eastern and western aspect with terrains slope up to 25°. In terms of height the highest percentage is in altitudes between 600 and 700 m a.s.l. (35,5%), i.e. thermal co-ordinate V=12.

By using the local heat potential of a region, it can be identified which sites, i.e. which combinations of exposure, slope and altitude belong to the particular tree species. Consequently, a more reliable selection of tree species can be done for the bio-reclamation of barrens and other deforested terrains.

REFERENCES

- Allen R., Trezza R., and Tasumi M. (2006). Analytical integrated functions for daily solar radiation on slopes. *Agricultural and Forest Meteorology*, Volume 139, Issues 1-2: 55-73.
- Bunuševac T. (1951). *Gajenje šuma*. Naučna knjiga, Beograd.
- Cogbill V., White S. (1991). The latitude-elevation relationship for spruce-fir forest and treeline along the Appalachian mountain chain. *Vegetatio* 94:153-175.
- Fang J.Y., Yoda K. (1988). Climate and vegetation in China (I). Changes in the altitudinal lapse rate of temperature and distribution of sea level temperature. *Ecological Research*, Vol. 3, No 1: 37-51.
- Friedland J., Boyce L., Vostral B., Herrick T. (2003). Winter and early spring microclimate within a mid-elevation conifer forest canopy. *Agricultural and Forest Meteorology*, Vol. 115, Issues 3-4, 195-200.
- Hayes M., Moody A., White P., Costanza J. (2007). The influence of logging and topography on the distribution of spruce-fir forests near their Southern limits in Great Smoky Mountains National Park, USA. *Plant Ecology*, Volume 189, Number 1: 59-70.
- Isajev V., Tucović A., Mataruga M. (2000). Ključne etape u proizvodnji namenskog sadnog materijala. *Glasnik Šumarskog fakulteta*, Beograd, 82: 73-80.
- Kimmins J.P. (2004). *Forest Ecology*. Third edition. Prentice Hall, Upper Saddle River, New Jersey.

- Kolić B. (1972). Uticaj ekspozicije terena i lokalnih uslova na promene mikroklimatskih elemenata u sastojini *Abieto-Fagetum* na Goču. In Serbian, Summary. Zbornik radova sa skupa: Aktuelni problemi šumarstva, drvne industrije i hortikulture, Beograd: 97-108.
- Krstić M. (1986). Influence of some elements of stand structure upon the light regime in a forest on the mountain Goc. In Serbian, Summary. Forestry 3-4, Belgrade: 51-64.
- Krstić M. (2000). Ecological characteristics of flora in the forest of Sessile oak with Turkey oak in East Serbia. Zbornik rezimea sa 6. Simpozijuma o flori jugoistočne Srbije, str. 49. Sokobanja.
- Krstić M. (2003). Kitnjakove šume Djerdapskog područja. Monografija Akademska misao, Beograd: 1-136.
- Krstić M. (2004). Uticaj potencijala lokalne toplote na rasprodanjenje bukovih šuma u severoistočnoj Srbiji. Šumarstvo 1-2, UŠIT Srbije, Beograd: 11-25.
- Krstić M. (2007). Klimatske karakteristike pojasa kitnjakovih šuma u Srbiji. Poglavlje u monografiji: Hrast kitnjak u Srbiji, str. 69-78. Univerzitet u Beogradu – Šumarski fakultet; Udruženje šumarskih inženjera i tehničara Srbije. Planeta Print, Beograd.
- Krstić M. (2008). Effect of the local heat potential on the distribution of sessile oak forests. Biotechnology & Biotechnological Equipment, Volume 22 No 3, pp. 804-809. Publisher: Diagnosis Press.
- Krstić M. (2006). Gajenje šuma. Šumarski fakultet u Beogradu, UŠIT Srbije, Beograd.
- Krstić M., Smailagić J., Nikolić J. (2001). Climatic characteristics of the Sessile oak forests (*Quercetum montanum serbicum* Čer. et Jov.) belt in Serbia. 3rd Balcan Scientific conference "Study, conservation and utilisation of the forest resources". 2-4. October, Sofia. Proceedings, vol. I: 200-209.
- Krstić M., Stojanović Lj. (2002). Prilog poznavanju klimatskih karakteristika istočne Srbije. »7th Symposium on flora of Southeastern Serbia and Neighbouring Regions«. Proceeding, 213-217.
- Krstić M., Ćirković T. (2005). Klimatsko-vegetacijske karakteristike područja Čemernika. »8th Symposium on flora of Southeastern Serbia and Neighbouring Regions«. Niš. Zbornik abstrakata, 111.
- Krstić M., Čevrljaković B. (2009). A contribution to the sessile oak site and beech site defining in central Serbia. Glasnik Šumarskog fakulteta br. 100, str. 143-158, Beograd.
- Leibundgut H. (1951). Der Wald eine Lebensgemeinschaft, Zürich.
- Lujčić R. (1960). Lokalni toplotni faktor i njegova uloga u rasporedu vegetacije. Glasnik Šumarskog fakulteta br. 18, Beograd: 1-130.
- Ohsawa M. (1990). An interpretation of latitudinal patterns of forest limits in South- and East-Asian mountains, Journal Ecol. 78 (1990), pp. 326–339.
- Ratknić M., Toković Z. (2001). Razrganičenje poljoprivrednog i šumskog zemljišta. Poglavlje u monografiji: Stanje, problemi i unapređenje gazdovanja privatnim šumama. Ministarstvo za poljoprivredu, šumarstvo i vodoprivredu, Beograd.
- Richardson A.D., Lee X., Friedland A.J. (2004). Microclimatology of treeline spruce-fir forests in mountains of the northeastern United States, Agricultural and Forest Meteorology 125 (2004), 53–66.
- Smailagić J., Krstić M., Cvjetičanin R. (2002). Climate and vegetation characteristics of the mountain Deli Jovan in East Serbia. 18th International Conference on Carpatian Meteorology, Belgrade, 7-11. October, Belgrade. Proceedings (printed as CD version).
- Soljanik I. (1960). Ekspozicija kao faktor pri pošumljavanju goleti. Poljopr.-šumarska komora, Priština.
- Tang Z., Fang J. (2006). Temperature variation along the northern and southern slopes of Mt. Taibai, China. Agricultural and Forest Meteorology, Volume 139, Issues 3-4, pg. 200-207.

ANALYSIS OF GROWTH, INCREMENT AND VOLUME OF DOMINANT TREES OF EASTERN WHITE PINE AND DOUGLAS-FIR ON SITE OF SESSILE OAK

Spasojević Branka, Čokeša Vlado, Jović Đorđe, Stanković Dragica

Spasojević B., Čokeša V., Jović Đ., Stanković D. (2015). Analysis of growth, increment and volume of dominant trees of eastern white pine and Douglass-fir on site of sessile oak. In: Ivetić V., Stanković D. (eds.) Proceedings: International conference Reforestation Challenges. 03-06 June 2015, Belgrade, Serbia. *Reforesta*. pp. 134-143.

Abstract: We measured the volume and growth increment of 51-year-old dominant trees in stands of fast-growing conifer species, Douglas-fir (*Pseudotsuga menziesii* (Mirb.) Franco) and eastern white pine (*Pinus strobus* L.) on Podrinjsko – Kolubarsko forest area in Management Unit “Cer – Vidojevica”, Republic of Serbia. The plantations are on a site formerly occupied by sessile oak (*Quercus petraea* (Matt.) Liebl). Our main objective was to determine if the introduction of alien conifer species to sessile oak sites was justified. Based on our results it can be seen that artificially established stands of Douglas-fir and eastern white pine have a very high volume that at age 50 exceeds the volume of autochthonous sessile oak stands of the same age by three times. At age 50 for Douglas-fir the average volume was 483.90 m³/ha and for eastern white pine the average volume was 372.5 m³/ha. In a 70-year-old sessile oak stand the volume value was 283 m³/ha. However, during the last ten years there has been extensive dieback of trees as well as the dieback of entire stands of introduced alien species for environmental reasons (the problem of preserving the biodiversity of autochthonous species and forest ecosystems) and based on a general state of plantations after age of 40 (weakened vitality, extensive dieback). The reasons for dieback partly lies in poor plantation management (thinning operations), but the main reason is unsuitable site (low elevation, southern exposure, lack of moisture). For these reasons, these species cannot be recommended for substitution of coppice forests of sessile oak in this area. Still, if is our decision to continue with afforestation with this alien species we should consider their mixture with broadleaves species and shortening the rotation period to 40 years, which is half the length of the rotation period planned for these species.

Key words: artificially established stands, eastern white pine, Douglas-fir, sessile oak stand, volume, afforestation, growth and increment, dominant trees.

INTRODUCTION

At the time of intense introduction of conifers in Serbia which started in 1960s the extensive afforestation of barren soil and amelioration of degraded and broadleaved coppice forests were carried out in the area of Forest management unit "Cer-Vidojevica". Various methods of clear or partial cutting were applied with the introduction of allochthonous, mostly conifer tree species. When selecting species for afforestation of

barren soil and amelioration of degraded and broadleaved coppice forests enough attention has not been paid to the complex characteristics of the site conditions but there were established conifer monocultures often on unsuitable sites which later resulted in the massive dieback of introduced species and sometimes in the complete destruction of these plantations.

The conifer species that have been most commonly used are the autochthonous conifers: Austrian pine (*Pinus nigra* Arn.) and Scots pine (*Pinus silvestris* L.), to a less extent there is common spruce (*Picea abies* L.) and rarely silver fir (*Abies alba* Mill.). Since 1970s on sites with great production potential the following alien species and autochthonous fast-growing species were mostly used for afforestation: eastern white pine (*Pinus strobes* L.), Douglas-fir (*Pseudotsuga menziesii* (Mirb.) Franco), European larch (*Larix decidua* Mill.), white fir (*Abies concolor* Engelm) etc. The obtained results were different due to lack of experience.

Share of artificially established conifer stands in the studied Forest management unit is 456.31 ha (12%). A similar situation was noticed in other Forest management units (10-15%). In a total volume are represented the following conifers: Austrian pine 42%, spruce 31%, Scots pine 13%, eastern white pine 8% and Douglas-fir 5% (Special basis for managing forest in Forest Management Unit "Cer-Vidojevica", 2013-2022).

According to Stojanović et al. (2010) the following authors have done researches on artificially established stands of introduced conifer species in Serbia and they also have dealt with the issue of the species substitution: Vrcelj–Kitić (1982), Tomanić et al. (1990), Vučković et al. (1990), Stamenković (1994), Tomanić (1994), Dražić (1994), Koprivica et al. (1996), Krstić (1998, 2006), Koprivica et al. (2002), Stajić (2006), Bjelanović (2008), Vukin et al. (2008) etc. Production and structural characteristics of spruce, Austrian and Scots pine plantations have mostly been studied while the researches for the allochthonous conifer species have been performed only partially. The main goal of the research presented in this paper is to emphasize the specificity of growth of Douglas-fir and eastern white pine dominant trees in the stands established during the process of substitution of sessile oak coppice forests in the area of Vidojevica in 1960s, as well as to determine the justification for the introduction of these alien species into "someone else's" site.

MATERIAL AND METHOD

Researches were carried out in north-western Serbia, in Vidojevica which is north-western part of the mountain Cer. According to the administrative-political division of space the Forest Management Unit "Cer-Vidojevica" is located in the area of political municipalities Loznica and Šabac as well as in the area of several other cadastral municipalities. Cer is a low mountain that entirely belongs to oak belt. In the area of oak forests there are also mountain beech forests.

In the studied stands nine sample plots (SP) were established, per four in the artificially established stands of eastern white pine and Douglas-fir at around 50 years old site of sessile oak with hornbeam (*Quercus-Carpinetum moesiicum* Rudski) and one sample plot in the coppice stand of sessile oak (*Quercus petraea* (Matt.) Liebl), aged around 70 years.

It should be noted that these artificially established stands due to intensive dieback were subject to frequent sanitation cutting in the last decade and the consequence of that practice are clearings that were created on larger areas. The sample plots were established in more homogeneous conditions so they cannot represent the general situation in the whole area of FMU "Cer-Vidojevica" especially in terms of quality and health status.

Elevation on the studied location ranges from 150 meters to 200 meters and the average slope of the terrain is around 15°. The studied stands are located at different exposures. The geological substrate consists of schist (SP I and SP IX) and phyllite (on the other sample plots). The soil in the SP I and SP IX is medium deep, brown, illimerised (leached) and also the deepest in comparison to other studied fields. At the other sample plots the soil is medium deep, acidic and brown. For the average climate year, the mean annual air temperature is 11.1° C and the mean annual precipitation is 825.8 mm.

Except the study on the growth specificity of eastern white pine and Douglas fir dominant trees, based on data on detailed measurements conducted in the sample plots it was determined the structure (diameter structure, distribution of basal area, volume, height curve), the volume level and volume increment, and a special attention was paid to determine the quality and health status of trees and stands.

Collection of taxation data was done using regular operation method. The quality of the studied stands was determined by the method of the Faculty of Forestry in Belgrade (evaluation of biological position, quality of the stem and quality of the crown) Stamenković (1974) and the evaluation of the decline index was performed by ICP Forests method. Data processing was carried out also by the usual method for this type of research.

In order to analyse the characteristics of diameter, height and volume increment of trees at the SP I, SP II (Douglas fir) and SP IV, SPVI (eastern white pine) the dendrometric analysis of the medium trees of dominant storey (20% thickest and at the same time tallest trees) was performed using cross-sectional method. Then the data were analysed by computer using specialized software (Marković 2001).

RESULTS AND DISCUSSION

Basic data on stands

Basic data on studied, artificially established stands of eastern white pine and Douglas-fir as well as on autochthonous coppice stand of sessile oak are presented in the following table (Table 1).

Number of trees in the artificially established stands of Douglas-fir ranges from 370 to 499 per hectare. Curves that present distribution of trees per diameter degrees show that the maximum of the representation of trees is in the diameter degrees of 32.5 cm and 37.5 cm. Mean stand diameter ranges from 33.0 to 37.6 cm and the mean height ranges from 23.9 – 32.1 m. The diameter of the mean tree of the dominant storey ranges from 44.40 to 47.90 cm and the height from 26.10 to 35.70 m. The basal area ranges from 37.82 m²/ha to 49.24 m²/ha, averagely 43.39 m²/ha, the wood volume ranges from 380

m^3/ha to $541.9 \text{ m}^3/\text{ha}$, averagely $483.90 \text{ m}^3/\text{ha}$ and the volume increment ranges from $5.57 \text{ m}^3/\text{ha}$ to $7.05 \text{ m}^3/\text{ha}$, averagely $6.54 \text{ m}^3/\text{ha}$.

Table 1. Basic data on stands

Numerical indicators	Douglas-fir				Eastern white pine				Sessile oak
	SP I	SP III	SP VII	SP II	SP IV	SP V	SP VIII	SP VI	SP IX
N (pcs./ha)	370	499	485	414	458	461	490	326	304
D_g (cm)	37,60	34,60	33,00	33,50	31,80	31,20	27,80	34,10	31,98
D_{g20%} (cm)	47,90	47,00	45,20	44,40	39,60	38,60	36,80	41,40	37,60
h_{dg} (m)	32,10	26,70	25,30	23,90	23,20	22,20	22,60	22,15	23,00
h_{dom} (m)	35,70	30,30	30,00	26,10	24,90	24,10	23,60	23,40	23,50
G m²/ha	42,83	49,24	43,65	37,82	36,93	36,66	32,04	29,88	25,79
V m³/ha	530,70	541,90	484,80	380,00	419,00	400,00	346,60	324,50	283,00
Iv m³/ha	5,57	7,05	6,51	7,03	6,14	6,62	4,31	4,56	2,40

Number of trees in the studied stands of eastern white pine ranges from 326 to 490 per hectare and the maximum of the representation of trees is in the diameter degrees of 27.5 cm and 32.5 cm. Mean stand diameter ranges from 27.8 to 34.1 cm and the mean height ranges from 22.2 to 23.2 m. Mean diameter of the mean tree of the dominant storey ranges from 36.80 to 41.40 cm and the height from 23.40 to 24.90 m. The basal area ranges from $29.88 \text{ m}^2/\text{ha}$ to $36.93 \text{ m}^2/\text{ha}$, averagely $33.87 \text{ m}^2/\text{ha}$, the wood volume ranges from $324 \text{ m}^3/\text{ha}$ to $419.0 \text{ m}^3/\text{ha}$, averagely $372.5 \text{ m}^3/\text{ha}$ and the volume increment ranges from $4.31 \text{ m}^3/\text{ha}$ to $6.62 \text{ m}^3/\text{ha}$, averagely $5.40 \text{ m}^3/\text{ha}$.

For the analysis of justification of alien conifer species introduction on the sessile oak site in this area, the structural and production characteristics of an autochthonous stand of sessile oak with hornbeam aged 70 years have also been studied. Number of trees is 304 per hectare. Distribution of taxation elements per diameter degrees is very regularly bell-shaped, but in the stand there are a small number of predominant trees in the diameter degree of 67.5 cm. These trees should certainly be removed in the preparatory cut which will ensue in this stand.

Most of the trees, the basal area and the volume as well as the tree with the mean stand diameter are distributed in the central diameter degree (32.5 cm). The mean stand diameter is 31.98 cm and the mean height is 23.0 m. The diameter of the mean tree of the dominant storey is 37.60 cm and the mean height is 23.50 m. The values of the basal area ($25.79 \text{ m}^2/\text{ha}$), the volume ($283 \text{ m}^3/\text{ha}$) and the volume increment ($2.40 \text{ m}^3/\text{ha}$) are significantly lower than in the fast-growing conifers (the current volume increment in the studied stands of fast-growing conifers, although in decline, almost three times exceeds the values of volume increment in the autochthonous sessile oak stands). The production fund of this stand is considerably higher than the estimated optimum for Serbia which is $200 \text{ m}^3/\text{ha}$ according to Milin et al. (1987). The volume increment is lower than estimated optimum for coppice sessile oak forests in Serbia (it is $5 \text{ m}^3/\text{ha}$ according to Milin et al. 1987) as well as below its average for the sessile oak forests for production purposes which, according to Aleksić (2005) is $3.7 \text{ m}^3/\text{ha}$.

Growth and increment of Douglas-fir dominant trees

For dendrometric analysis of the growth of Douglas fir trees were taken two trees: a medium tree in the dominant storey of the best quality stand (SP I) and a medium tree in the dominant storey from the stand of the lowest quality (SP II).

In figures 1 and 2 are shown the growth of diameter, height and volume, as well as the current and average diameter, height and volume increment of the medium tree in the dominant storey in the SPI and SPII.

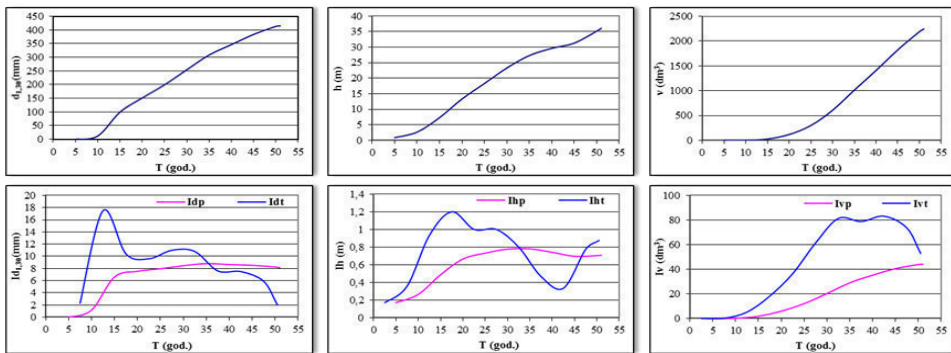

Figure 1. Growth and increment of the mean tree in the dominant storey in SP I

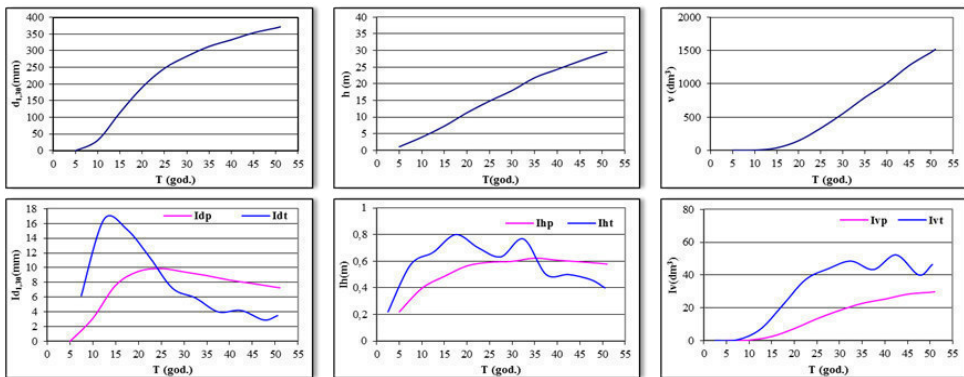

Figure 2. Growth and increment of the mean tree in the dominant storey in SP II

The curve which shows the diameter growth in the first ten years slowly increases (as a result of adjustment) and later it shows an intense increase until the age of 20 after which the growth becomes steadier. At the final analysed age (51 years) Douglas fir has reached the diameter value (without bark) of 41.5 cm (SP I) or 37.15 cm (SP II). Growth curves show that in the beginning the trees grew significantly faster in height than in thickness and that the growth of trees is recently slower in both the height and the thickness. The culmination of the current diameter increment is occurred around the age of 12-13 with a value of 16.6 mm (SP II), or around the age of 10-15 with a value of 17.5 mm (SP I). After the culmination, with minor fluctuations, it gradually begins to decline. The sanitation felling that was carried out at stand age 25-30 years contributed to the

slower decline of the current diameter increment. The fact that the diameter increment culmination occurred very early indicates the necessity of silvicultural measures in young stands for the preservation of their stability and prevention of wood volume loss. The average diameter increment culminated later, around the age of 35, when it reached value of 8.8 mm (SP I) or around age 25 (SP II) reaching the value of 9.88 mm.

The height increase was also slowly until age of 10 when it starts to increase steadier to the age of 30-35 whereupon the growth curve was again flatter. At the final analysed age, Douglas fir has reached the height of 36.05 m (SP I) or 29.5 m (SP II). The culmination of the current height increment in SP I occurred around the age 18 when its value was 1.20 m. In SP II, the culmination occurred around the age of 15 (0.8 m). After the culmination the current height increment has a downward trend, which also indicates the necessity of thinning on time. The average height increment culminated later, after age of 30 years in SP I or 35 years in SP II when it reached the values of 0.78 m and 0.62 m. For a longer period after the culmination it kept quite high values (at age of 51 it had the value of 0.58 m in SP II). All these contributed to remaining the current volume increment at a high level until today. It culminated around the age of 40 when it reached a value of 0.083 m³, after what it began to decline and in the age of 50 it reached a value of 0.052 m³ (SP I). If the thinning was timely performed this would probably happen a little bit later. Very quickly, around the age of 50, the average periodic increment culminated and equalized with the current volume increment. In this period in the stand there was the greatest wood volume. From the age of 40 in the stand started the self-thinning and self-pruning of the lower branches. For the studied artificially established stands on the given site, this was the age when they started to dry more intense and it can be assumed that in the age of 40 they reached the biological optimum. In SP II, at the moment of culmination it reached a value of 0.052 m³. The average biological optimum has not culminated yet. In the age 51, the volume (without bark) is 2.24 m³ in SP I or 1.52 m³ in SP II, with the average increment of 0.043 m³ in SP I, and 0.029 m³ in SP II.

Growth and increment of eastern white pine dominant trees

For dendrometric analysis of the growth of eastern white pine trees were taken two trees: a medium tree in the dominant storey of the best quality stand (SP IV) and a medium tree in the dominant storey from the stand of the lowest quality (SPVI).

In figures 3 and 4 are shown the growth of diameter, height and volume, as well as the current and average diameter, height and volume increment of the medium tree in the dominant storey in the SPIV and SP VI.

At the final analysed age (51 years) eastern white pine reached the diameter (without bark) of 36.6 cm and the height of 26.15 m in SP IV, and the diameter of 38.4 cm and the height of 23.9 m in SP VI. The current height increment culminated very early, around age 12-13, and it had the value of 1.05 m in SP IV and 0.76 m in SP VI. This means that the height differentiation of trees occurred very early and that the positive selection i.e. the first selective thinning should have started early. The culmination of the average height increment occurred later, around age of 20 years in SP IV with the value 0.76 m, and around age of 25 years in SP VI with the value 0.63 m in SP VI. Having in mind that in the moment of the height increment culmination the current diameter increment also

culminated (16.3 mm - SP IV and 18.8 mm - SP VI) the first thinning also had been late. After this age, the current diameter increment was in a very gradual decline which means that the thinning was carried out in the stand (probably the selective-sanitation thinning). The average diameter increment culminated later, around the age 15 in SP IV, and its value was 12 mm. In the age 51 it had the value of 7.17 mm. In SP VI the culmination occurred around the age 18 (11.4 mm) and at the final analysed age it had the value of 7.5 mm. The current volume increment in SP IV culminated around the age 40-45 (0.045 m³). In SP VI it also culminated less than 10 years ago, when the stand was in the biological optimum and it had the value of 0.063 m³ after which it started to decline and in the age of 50 it reached the half of the previous value (0.032 m³). The current volume increment has not yet reached its maximum, but observing its trend that will happen in the next few years. In the age 51 the volume (without bark) is 1.45 m³ in SP IV, or 1.50 m³ in SP VI, with the average increment of 0.029 m³ (SP IV and SP VI).

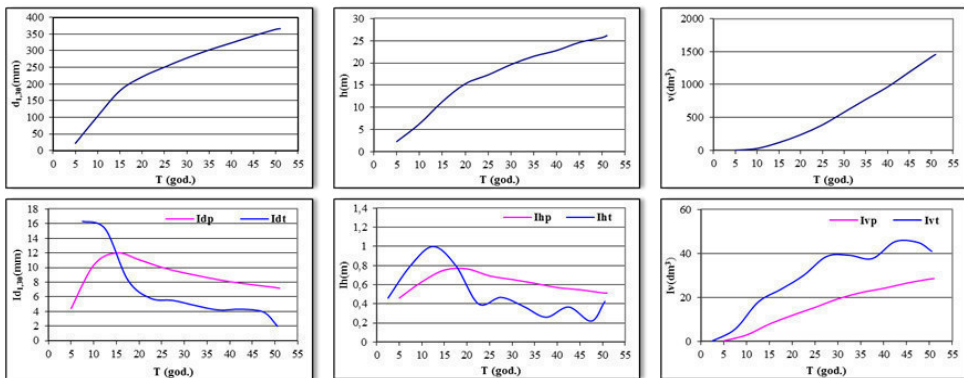

Figure 3. Growth and increment of the mean tree in the dominant storey in SP IV

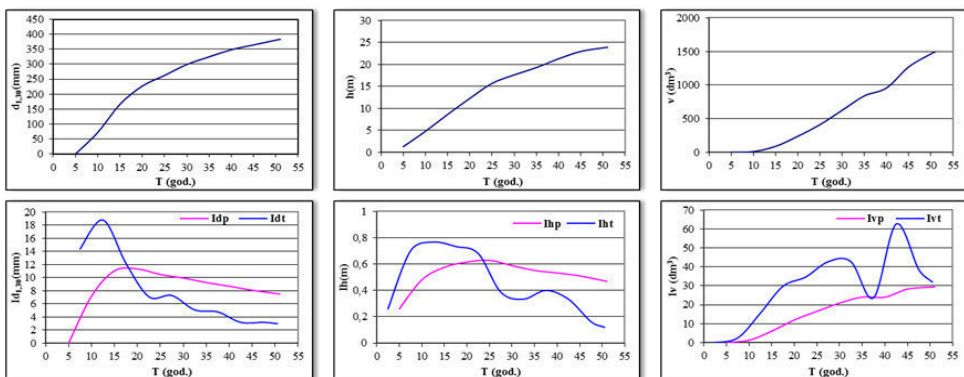

Figure 4. Growth and increment of the mean tree in the dominant storey in SPVI

The obtained results are in accordance with the research results of Koprivica et al. (2002) for artificially established stands of eastern white pine and Douglas-fir on oak stand in the area of Raška, Stajić et al. (2006) for artificially established stands of eastern

white pine and Douglas-fir on site of Hungarian oak and Turkey oak with hornbeam in the area of Bukulja and Bjelanović et al. (2010) for Douglas-fir plantation established on the site of mountain beech forest in the area of Majdanpek.

According to researches on tree development in mesophile coppice stand of sessile oak with hornbeam (*Quercetum montanum subass. carpinetosum betuli*) on lessive acid soil (luvisol on acid silicate substrates) Čokeša (2007) the current height increment culminated in the age of 15. In this stand the differentiation and the period of the negative selection finished early and the non-productive phase of sapling which required thinning also finished quickly so the stand early entered into the productive phase of thinning. This initial situation left a positive mark on present condition of the stand. According to the same author, the current diameter increment also early culminated and the culmination of the current volume increment of dominant trees in mesophile sessile oak stands happens just around age of 70. The average volume increment will probably culminate around the age 90. If the quality of the dominant trees is low, this is the period when the regeneration felling should start.

CONCLUSION

The analysis of the research results shows that the artificially established eastern white pine and Douglas-fir stands have a very high productivity which at the age of 50 up to three times exceeds the productivity of autochthonous sessile oak stands. The artificially established stands had a very intense development until the age of 40, the height and diameter increment was very pronounced, they were vital and had a high quality and a good health status. However, in the last ten years the increment attenuated, the vitality declined and the dieback occurred more often. The reasons for major damages caused by drought should be looked for at low elevations where these plantations were established. Severe droughts in recent years have led to physiological weakening of trees and their predisposition to be attacked by various pathogens.

Even the autochthonous species such as sessile oak, in both coppice and high stands, is not immune to the dieback processes. The present condition of coppice sessile oak forests is certainly not acceptable. Their productivity, quality, health status and age structure are not satisfactory. They do not use optimally the site in which they are located. It turned out that the introduced alien species use it better. However, the autochthonous sessile oak stands are more environmentally friendly. Sessile oak natural ecosystems are more stable at a longer-term. They affect favourably on site and biodiversity conservation of other species so there is a lot of reasons not to give up on sessile oak as primary species on these sites. Its sites should not be even left to a greater extent to the species that grow spontaneously on them like hornbeam and linden, which are an integral part of this community, and especially not to manna ash, hawthorn, wild rose, blackthorn and blackberry.

The solution to the problem with the sessile oak forests is not in their substitution by alien species forests whose introduction into autochthonous ecosystem has more negative effects for biodiversity and site than clear cutting or fire, but it lies in improvement of their condition and structure.

Based on the aforementioned we can conclude that the artificially established stands of eastern white pine and Douglas fir have shown good productivity in these conditions, but they should be used exclusively for the establishment of intensive plantations with a short rotation. For a longer rotation the potential of the site is unsuitable (elevation of 150-200 m is unsuitable as well as adverse climatic conditions). The recommendation is to perform this on the small areas with avoiding of establishment of monocultures and taking into account the bio-ecological characteristics of mentioned conifers. Particular attention should be paid to the selection of suitable provenances which have proved resistant to the effects of different abiotic and biotic factors which endanger the viability of these species in our conditions.

Between the two studied species the priority should be given to Douglas fir, primarily due to a greater resistance to adverse abiotic and biotic factors, and also due to the wood of great quality which by its technical characteristics exceeds almost all domestic conifers. Eastern white pine is in our country very endangered by various pathogens, so it is often affected by dieback. In addition, its tree is brittle, fragile and low quality, which is why its stands are unstable with respect to adverse abiotic factors (wind, snow and ice). Based on its technical characteristics the quality of eastern white pine is below the quality of autochthonous coniferous species, so there is a question of justification of its breeding.

So, the solution to the problem of autochthonous coppice forests of damaged structure has to be sought not in substitution of species by introduction of alien conifers, but in their conversion into higher silvicultural form, i.e. into high-generative forests. Only such forests could be compared with the introduced alien species of generative origin.

REFERENCES

- Aleksić P. (2005). Condition of oak forests managed by Public Enterprise "Srbijašume", Forestry journal 3, The Association of Forestry Engineers and Technicians of Serbia, Belgrade.
- Bjelanović I., Vukin M. (2010). Thinning in artificially established stands of Douglas fir, spruce, Austrian and Scots pine in the area of Majdanpek. Šumarstvo No. 1-2. The Association of Forestry Engineers and Technicians of Serbia, Belgrade.
- Čokeša V. (2007). Research of mature coppice forests of sessile oak due to their conversion into a higher silvicultural form in the area of the mountain Cer. Master Thesis, Faculty of Forestry, Belgrade.
- Koprivica M., Tabaković-Tošić M., Topalović M., Rakonjac Lj., Čokeša V., Marković N. (2002). Environmental, production and health characteristics of artificially established stands of conifers in the area of Raška. Special issue, Public enterprise for forest management "Srbijašume", Institute of forestry, Belgrade.
- Krstić M. (2006). Silviculture - conversion, amelioration and artificial regeneration. Faculty of forestry in Belgrade and the Association of Forestry Engineers and Technicians of Serbia, Belgrade.
- Marković N. (2001). Specialized software for the analysis of the tree development.
- Medarević M. (2006). Forests management planning. Faculty of forestry, Belgrade.
- Medarević M., Aleksić P., Milić S., Sklenar K. (2002). State of conifer plantations and artificially established stands of conifers which are managed by Public enterprise for forest management "Srbijašume". Special issue; Public Enterprise "Srbijašume" and Faculty of forestry, Belgrade.

- Medarević M., Banković S., Pantić D. (2006). Sessile oak forests in Serbia. Forestry journal No. 3. The Association of Forestry Engineers and Technicians of Serbia, Belgrade.
- Medarević M., Banković S. (2008). Forests of Serbia today. "Forests" No. 100, Public Enterprise "Srbijašume", Belgrade.
- Milin Ž., Stojanović Lj., Krstić M. (1987). Some possible causes of dieback of sessile oak forests in north-eastern Serbia. Forestry journal No. 5. Belgrade.
- Spasojević B. (2014). Management problems in artificially established stands on mountain Vidojevica. Master Thesis, Faculty of forestry, Belgrade.
- Stajić S., Rakonjac Lj. (2006). Introduction of conifers on the site of Hungarian oak and Turkey oak in the area of Bogovadja. Forestry journal No. 3. The Association of Forestry Engineers and Technicians of Serbia, Belgrade.
- Stamenković V. (1974). Increment and productivity of trees and forest stands, a temporary book, Publishing and Information Centre of Students (ICS), Belgrade.
- Stojanović Lj., Krstić M., Bjelanović I. (2010). Stand state and silvicultural treatments in plantations of larch, eastern white pine and Douglas fir in the area of Majdanpek. Forestry journal No.1-2. The Association of Forestry Engineers and Technicians of Serbia, Belgrade.
- Special basis for managing forest in Forest Management Unit "Cer-Vidojevica", (2013-2022), FE "Boranja", Loznica.

EUROPEAN WHITE ELM: POTENTIAL FOR WETLANDS REFORESTATION

Devetaković Jovana, Mitrović Bojan, Milosavljević Marija, Nonić Marina, Stanković Dragica

*Corresponding author: jovana.devetakovic@sfb.bg.ac.rs

Devetaković J., Mitrović B., Milosavljević M., Nonić M., Stanković D. (2015). European white elm: Potential for wetlands reforestation. In: Ivetić V., Stanković D. (eds.) Proceedings: International conference Reforestation Challenges. 03-06 June 2015, Belgrade, Serbia. *Reforesta*. pp. 144-148.

Abstract: The aim of this study was to investigate the potential of European white elm (*Ulmus laevis* Pall.) for wetland reforestation across the Europe. For this purpose, seed was collected from 13 maternal European white elm trees on Veliko ratno ostrvo island near Belgrade, Serbia. Seeds were used to produce bareroot seedlings (1+2) that were planted at Veliko ratno ostrvo (20°25'40" E; 44°50'18" N) on fall (689 seedlings) and at Manić-Bostanište (20°25'02" E; 44°30'54" N) on spring (260 seedlings).

After the first growing season in the field, seedlings survival was estimated and seedling growth was measured. Survival was relatively similar and high on both sites (~90%). Wildlife was the most common reason for seedling mortality and damage (100% of dead seedlings at Manić-Bostanište). Seedling growth was strongly influenced by time of planting and site conditions. Seedlings planted on autumn at Veliko ratno ostrvo island showed approximately double growth compared to seedlings planted at spring at Manić-Bostanište. The highest value of diameter increment (24 mm), total diameter (39 mm), height increment (252 cm) and total height (432 cm) were recorded on the site Veliko ratno ostrvo, while the lowest values of total diameter (9,29 mm) and total height (65 cm) were recorded at Manić-Bostanište, also as the absence of growth in some plants.

Due to high survival rate and large growth at both sites, European white elm can be considered a species with high potential for reforestation of wetlands for conservation and productive purposes.

Key words: seedlings, European white elm, reforestation, survival, growth performance.

INTRODUCTION

European white elm (*Ulmus laevis* Pall.) is a hardwood deciduous tree which grows in river banks, lake shores and other wetlands (Collin et al. 2000). Areal of European white elm is from Ural Mountain on the east to eastern France on the west, and from southern Finland on the north to the Caucasus, Balkans and southern France (Collin 2003). Natural populations of European white elm are rare in Europe and number of trees in these populations is reduced as a result of Dutch elm disease (DED) and human-induced changes in riparian forest (Machentun 2000) and measures for conservation are provided (Collin et al. 2004).

Wetlands in Europe include river deltas, coastal lagoons, riverine floodplains, inland freshwater lakes, man-made reservoirs, a thalassic salt basins, intertidal systems, permanent river channels, and seasonally-flooded river channels (Crivelli and Britton 1993). People have great influence on these habitats and in some parts of Europe are occurring dramatic changes in landscape, which causing great damage in these ecosystems (Hook 2006, Pfadenhauer and Grootjans 1996). Riparian forests throughout the world provide important ecosystem services such as flood abatement, water-quality improvement, wildlife habitat, and biogeochemical cycling (Haycock et al. 1993, Mitsch and Gosselink 2000). Restoration and reforestation of wetlands should be possible with native species like European white elm which would help conservation except restoration.

MATERIAL AND METHOD

Study Site

The field experiment was established on two sites: Veliko ratno ostrvo island (E 20°25'40"; N 44°50'18"; 73 m above sea level) and Manić-Bostanište (E 20°25'02"; N 44°30'54"; 121 m above sea level), which are included on the same climate region, with small oscillations and microclimatic variations between sites.

Both sites belongs area of Belgrade with average of temperature 12.2° C, during vegetation 18.9° C and with extreme temperatures on July (average 22.5° C) and January (average 0.8° C), average annual rainfall is 693,3 mm, during vegetation 392.5 mm with a lack of humidity during July, August and September (154 mm). Average value of the General climate index for Belgrade is 0.80065 for the period 1946-2010, which indicates a sub-humid humid climate (C2). The normal growing season is from April until October (http://www.hidmet.gov.rs/podaci/meteorologija/Klima_Srbije_eng.pdf).

Site Veliko ratno ostrvo belongs protected natural area "Veliko ratno ostrvo" on confluence Sava and Danube River near Belgrade. Before planting, weeds were cut with absence of agricultural activities, and planting was done on November 2013th. Soil type is fluvisol. This area is influenced by Danube and oscillations of the stage have great influence on the ground water level. Flooding is common during spring (one time on April or May, during 7-15 days), also as driest period during July and August when ground water level is lowest (deeper than 1 m).

Site Manić-Bostanište present abandoned agriculturally area where was doing cleaning of weeds and plowing and after that soil was disk. This area have big influence of local small rivers around them and flooding is common (average one or two per year on May or June, during 1-7 days), except ground water level is high (about 30-50 cm below ground on July). Soil type is eugley, sub type amfigley. Planting of seedlings were done on spring 2014th.

During May 2014th on both sites were flooding. Veliko ratno ostrvo site was flooding during 2 weeks and Manić-Bostanište during 5 days.

Seedling Production and planting

European white elm seeds for this study were collected from the natural stand found on Veliko ratno ostrvo island in May 2011th. After short drying in same month it is

sown on seedbeds in nursery Manić (E 20°25'41"; N 44°30'54"; 188 m above sea level) near site Manić-Bostanište. About 1200 seeds per m² were sown, and after first growing season seedlings were planted in rows at a spacing 20 cm between seedlings and 70 cm between rows. Two years after, bareroot seedlings (1+2) were planted by hands on two sites. All seedlings were tallest than 140 cm.

Sample of 689 seedlings were planted in 3 blocks on the Veliko ratno ostrvo at spacing 3.0 x 3.0 m in mid-November 2013th.

Sample of 260 seedlings were planted as one block on the Manić Bostanište at spacing 2.0 x 3.0 m in early March 2014th.

Measurements

Initial seedlings diameter (2 cm above root collar) and height were determined of each seedling in the all rows on the both sites after planting (December 2013th – Veliko ratno ostrvo; March 2014th – Manić-Bostanište). During growing season seedlings were monitored on both sites, survival counts and diameter and height measurements were taken on December 2014th.

Statistical Analyses

Descriptive statistic parameters were used to show average diameter and average height before and after first growing season on sites, diameter and height increment was observed and survival of seedlings. Analysis of variance (One-Way ANOVA) was used to indicate differences between sites. Significant differences between variables are determined by Tukey HSD post-hoc test ($p < 0.05$). Statistical analyses were performed with the help of the computer software package Statistica 7.1.

RESULTS

Survival is similar after the first growing season on the field, on the Veliko ratno ostrvo is 90% and on site Manić-Bostanište is 90.38%, but seedling diameter increment, height increment and total height are significantly different. Total diameter average is not statistically different between sites (Table 1).

Wildlife was the most common reason for seedling mortality and damage, 100% of dead seedling on the site Manić-Bostanište and about 50% on the site Veliko ratno ostrvo.

Table 1. Survival counts and growth measurements of European white elm seedlings on two sites after first growing season

Site	Survival (%)	Diameter increment (mm)	Height increment (mm)	Total diameter (mm)	Total height (mm)
Veliko ratno ostrvo	90 ^a	7,63 ^b	71,98 ^b	20,83 ^a	203,27 ^b
Manić-Bostanište	90,38 ^a	4,32 ^a	19,37 ^a	20,45 ^a	169,25 ^a

*Means within each column followed by the same letter are significantly different ($p < 0,05$)

The highest value of diameter increment (24 mm), total diameter (39 mm), height increment (252 cm) and total height (432 cm) were recorded on the site Veliko ratno ostrvo, while the lowest values of total diameter (9 mm) and total height (65 cm) were recorded at Manić-Bostanište, also as the absence of growth in some plants.

DISCUSSION

Wetlands have condition for fast and easy weed growth and in this case tall seedlings have priority relative to traditional seedlings which are height 20-40 cm (Cicek et al. 2007a). High survival after first growing season on the both sites indicates possibility for reforestation wetlands with European white elm.

Increment of height and diameter are high on both sites and are consistent with some earlier research (Cicek et al. 2007b). Flooding have bad influence on shoot and root growth and can caused death of seedlings (Kozłowski 1997, Sena Gomez and Kozłowski 1980), but frequency and intensity of flooding and plant species are very important (Vreugdenhil et al. 2006). European white elm seedlings have high degree of tolerant on flooding (Li et al. 2015) and flooding during 3 weeks on site Veliko ratno ostrvo or 5 days on site Manić-Bostanište did not cause high consequences. Differences between site conditions probably cause differences of increment. Seedlings on site Manić-Bostanište have less value of all observed parameters as a cause of combination clay soil and spring out planting.

CONCLUSIONS

High rate of survival on both sites show high potential of European white elm for reforestation of wetlands using tall seedlings. Diameter and height increment indicate possibility for next research and using European white elm for biomass production on wetlands.

Acknowledgments: This research was supported by grant from the Ministry of Education and Science of the Republic of Serbia and projects TR 37008 and TR 31041.

REFERENCES

- Britton R.H., Crivelli A.J. (1993). Wetlands of southern Europe and North Africa: Mediterranean wetlands. Wetlands of the world: Inventory, ecology and management Volume I, Handbook of vegetation science Volume 15-2, pp. 129-194.
- Collin E. (2002). Strategies and guidelines for the conservation of the genetic resources of *Ulmus* spp. In: Turok J, Eriksson G., Russell K. & Borelli S. (comp.). Noble Hardwoods Network, report of the fourth meeting, 4–6 September 1999, Gmunden, Austria and the fifth meeting, 17–19 May 2001, Blessington, Ireland. International Plant Genetic Resources Institute, Rome, Italy. p. 50–65.

- Collin E. (2003). EUFORGEN Technical Guidelines for genetic conservation and use for European white elm (*Ulmus laevis*). International Plant Genetic Resources Institute, Rome, Italy. 6 pages.
- Collin E., Rusanen M., Ackzell L., Bohnens J., de Aguiar A., Diamandis S., Franke A., Gil L., Harvengt L., Hollingsworth P., Jenkins G., Meier-Dinkel A., Mittempergher L., Musch B., Nagy L., Pâques M., Pinon J., Piou D., Rotach P., Santini A., Vanden Broeck A., Wolf H. (2004). Methods and progress in the conservation of elm genetic resources in Europe. Invest Agrar: Sist Recur For 13 (1), 261-272.
- Cicek E., Cicek N., Bilir N. (2007a). Effects of seedbed density on one-year-old *Fraxinus angustifolia* seedling characteristics and outplanting performance. New Forests 33: 81–91.
- Cicek E., Tilki F., Kulac S., Yilmaz M., Yilmaz F. (2007b). Survival and growth of three hardwood species (*Fraxinus angustifolia*, *Ulmus laevis* and *Ulmus minor*) on a bottomland site with heavy clay soil. Journal of Plant Science 2: 233-237.
- Haycock N.E., Pinay G., Walker C. (1993). Nitrogen-retention in river corridors - European perspective. Ambio 22:340–346.
- Hooke J.M. (2006). Human impacts on fluvial systems in the Mediterranean region. Geomorphology 79:311–355.
- Kozłowski T.T. (1997). Responses of woody plants to flooding and salinity. Tree Physiology Monograph No. 1 © 1997 Heron Publishing, Victoria, Canada.
- Mackenthun G.H. (2000): The role of *Ulmus laevis* in German floodplain landscapes. Invest Agrar: Sist Recur For (2004) 13 (1), 55-63.
- Mitsch W.J., Gosselink J.G. (2000). Wetlands. John Wiley, New York, New York.
- Pfadenhauer J., Grootjans A. (1999). Wetland restoration in Central Europe: aims and methods. Applied Vegetation Science 2: 95-106.
- Sena Gomes A.R., Kozłowski T.T. (1980). Effects of flooding on *Eucalyptus camaldulensis* and *Eucalyptus globulus* seedlings. Oecologia, Volume 46, Issue 2, pp 139-142.
- Vreugdenhil S., Kramer K., Pelsma T. (2006). Effects of flooding duration, -frequency and -depth on the presence of saplings of six woody species in north-west Europe. Forest Ecology and Management 236 (2006) 47–55.

**EARLY EFFECTS OF THINNING IN PLANTATION OF EASTERN COTTONWOOD
(*POPULUS DELTOIDES* BARTR. EX MARSH.), CLONE BORA ON THE SAVA RIVER
ALLUVIUM**

Andrašev Siniša*, Rončević Savo, Bobinac Martin

*Corresponding author: andrasev@uns.ac.rs

Andrašev S., Rončević S., Bobinac M. (2015). Early effects of thinning in plantation of Eastern Cottonwood (*Populus deltoides* Bartr. ex Marsh.), clone Bora on the Sava river alluvium. In: Ivetić V., Stanković D. (eds.) Proceedings: International conference Reforestation Challenges. 03-06 June 2015, Belgrade, Serbia. Reforesta. pp. 149-158.

Abstract: In the plantation of Eastern Cottonwood (*Populus deltoides* Bartr. ex Marsh.), clone Bora (working name B-229) on the Sava river alluvium, established in the planting distance of 5 × 5 m, early effects of thinning on permanent sample plots were analyzed for period of 8-11 years. The experiment was set up with two treatments, the experimental and the control, with three replications. In three experimental plots of 0.1225 ha combined heavy thinning was performed and three plots were control.

After removing 43.2-47.9% of trees on experimental plots were found significantly smaller trees per hectare (N), basal areas (G) and wood volumes (V) compared to control plots, while difference between diameter, basal area and volume of mean and dominant trees has not been found.

After three years differences between control and experimental treatments in elements of growth per hectare are smaller: basal area of 23.07 m²·ha⁻¹ and volume of 217.05 m³·ha⁻¹ on the control plot, and 15.96 m²·ha⁻¹ and 152.91 m³·ha⁻¹ on the experimental plot. Dominant diameters were not varied significantly (35.1 cm on both plots), but significant differences were found between diameter (28.9 cm on the control and 31.8 cm on the experimental plot), basal area and volume of mean tree. Also significant differences were found between current annual increment of diameter (1.35 cm·year⁻¹ on control compared to 1.82 cm·year⁻¹ on experimental plot), basal area and volume of mean tree, but not of dominant trees. Number of trees per hectare from which it is possible to make at least one log intended for cutting, class I, and their basal area and volume, were significantly greater in the control compared to the experimental plot three years after thinning. However, number of trees per hectare from which it is possible to make a higher quality log for peeling, and their basal area and volume, is not significantly different between the control and the experimental plot three years after thinning.

Poplars, as fast-growing species in our climate, strongly react to the regulation of growing space. The results show that the effects of thinning manifested in larger increment in diameter, basal area and volume of the mean tree, as well as larger relative share of higher quality assortments in the experimental plot compared to the control, already after three years.

Keywords: poplar, thinning, early thinning effects, growth elements.

INTRODUCTION

Poplars are fast-growing tree species that, on the region of Southeast Europe, are characterized by the highest productivity. As a light demanding tree species strongly react to density of plantation, ie. a space for tree growth, which allows the establishment of plantations with different densities for different purposes. Plantation density is the main element which conditions the purpose of production and targeted assortment (small timber, pulpwood, logs intended for cutting, peeling and veneer), and thus the quantity and quality of timber volume and length of rotation.

Research of poplar plantations production, depending on plantation density and systems of planting space in the last over 60 years, have enabled to group plantations into three groups (Marković et al. 1997b): I – plantation intended for the production of wood for pulp and paper industry (density from 1,000 to 10,000 trees per hectare); II – plantation intended for combined production of pulpwood and logs (density from 400 to 1,000 trees per hectare); III – plantation intended for production of logs (density from 150-400 trees per hectare).

In all the above plantation density thinnings can be performed which increases growing space of remaining trees and thereby change the target assortment which is determined by the initial plantation density. According to previous research thinnings is rationally conducted in plantation intended for combined production of pulpwood and logs, which are established with 400-1,100 trees per hectare (Pudar 1986, Marković et al. 1994, 1997b). Thinnings are carried out with the aim of obtaining the previous yield in the form of pulpwood, and it is expected that the remaining trees in the longer rotations achieve more quality assortments. Since the plantations established in the proper geometric arrangement thinning has a schematic character and intensity is usually 50%, where every second row is removed. In this sense, thinning is mainly regarded as an economic category.

As the poplar clone I-214 (*P. × euramericana* Dode Guinier) have been widely cultivated clone, both in Serbia and Europe, this conditioned that the previous studies of thinning in poplar plantations mainly related to this clone (Pudar 1986, Marković et al. 1994, 1997b).

The introduction of new poplar clones, primarily of Eastern cottonwood, was followed by research related to the application of thinnings in the plantations of these clones (Marković et al. 1998, 2001). In the Srem forest region in the last decade the share of newly registered clones of Eastern cottonwood has significantly increased, and in plantations established since 2003, their participation is prevalent in nurseries and young plantations (Pap et al. 2009). These plantations are established in the density of 5 × 5 and 6 × 6 m, which allow greater participation of thicker assortments, due to current market demands for more quality assortments.

Having in mind that the demand for certain assortments of poplars is a variable category in the period shorter than the length of the production cycle, there is a need to adapt to such circumstances. One of the possible solutions is the use of thinning in plantations with wide spacings (5 × 5 m, 6 × 6 m), with the aim of obtaining the previous

yield of the thinner assortments, and at the same time stimulating the diameter growth of the remaining, higher quality trees to achieve the larger diameter at the end of production cycle, or achieving a target diameter with a shorter production cycle.

Based on the growth elements of trees and plantations of new registered clone of Eastern cottonwood „Bora“, with a spacing of 5 × 5 m, in the 8th and 11th year since the plantation establishment, the paper analyzes the effects of early thinning conducted in the eighth year.

MATERIAL AND METHODS

Researches were conducted in an experimental plantation of the clone "Bora" (*Populus deltoides* Bartr. Ex Marsh.), working name B-229, which was established with one year old plants type 1/1 at planting distance of 5 × 5 m. Plantation is located in Forest holding „Sremskla Mitrovica“, management unit „Čenjin – Obreške širine“, in department 13 ($\varphi_n = 44^{\circ}42'$, $\lambda_e = 19^{\circ}57'$). In order to define the edaphic characteristics of habitat in the experimental field was opened pedological profile which was showed that soil, according to Škorić et al. (1985), belongs to the type fluvisol, variety double-layer on fossil soil (raked humogley on loess-alluvium) (Andrašev et al. 2011). In the first eight years, before establishment of experimental plots, in the plantation were performed usual tending measures: the row disking was done every year, and filling in and hoeing area with a width of 1 m around the plants was done two years after planting. The pruning of lower branches to the height of 6 m was also carried out in plantation, in order to obtain the best quality assortments at the end of the production cycle.

The experimental field is in the form of three blocks with two experimental plots, each the size of 0.1225 hectares, which are separated by a so-called „protective“ row. In each block on an experimental plot the selective thinning was carried out (experimental plot - EP), by defining and marking so-called „perspective trees“, approximately uniformly distributed over the area with an average distance of 7 × 7 m, ie. 204 trees·ha⁻¹. Since in young and middle-aged poplar plantations (age below 15 years) differentiation of trees according to biological categories is not expressed, and thinning is performed only once during the production cycle, so selection of so-called „perspective trees“ means selection of the final number of trees at the end of rotation. For this reason the selection criterias for these trees were: approximately uniform layout over the area (7 × 7 m); straight stem, without visibly expressed technical errors; regularly developed crown. All remaining trees in the experimental plot were removed. The remaining three plots were control plots (CP).

On the experimental and control plots all trees were numbered, and after 8 and 11 years their two cross diameter at breast height and total height were measured, with an accuracy of 1 mm and 1 dm, respectively. Data processing included standard procedure for finding the growth elements of mean and dominant trees, as well as growth elements per hectare (N, G, V) after 8 and 11 years, and the current increments in the period of three years. Volume per hectare is obtained as the volume of trees on the experimental plot multiplied by an appropriate coefficient. The volume of trees was obtained from the regression model, where the volume of trees is dependent and diameter at breast height

is independent variable obtained on the basis of a detailed measurement of felled trees after 8 year (Andrašev et al. 2011).

Descriptive statistics, regression analysis and t-test were used in the data processing with the aim of objective comparisons of growth elements of trees and plantation between different treatments.

RESULTS

In the the studied plantation on experimental plots thinning was performed after 8 years with an average intensity of 45.3% of number of trees, 37.2% of basal area and 36.3% of volume. Mean diameter of felled trees was 90.6% of the mean diameter before thinning. This indicates that the thinning was heavy by intensity, and low by character (Table 1).

Of the total amount $57 \text{ m}^3 \cdot \text{ha}^{-1}$, logs for cutting class II consist of $18.5 \text{ m}^3 \cdot \text{ha}^{-1}$ and pulpwood consists of $26.5 \text{ m}^3 \cdot \text{ha}^{-1}$ (Andrašev et al. 2011).

Table 1. Average values of growth elements of felled trees in the experimental plots after 8 years and their relative expression in relation to the total amount (Source: Andrašev et al. 2011).

Experimental field	d_g	d_{g20}	h_L	h_{g20}	N	G	V
	[cm]	[cm]	[m]	[m]	[tree·ha ⁻¹]	[m ² ·ha ⁻¹]	[m ³ ·ha ⁻¹]
EP	22.2	28.2	21.09	22.02	169	6,56	57.25
[%]	90.6%	96.2%	98.9%	100.0%	45.3%	37.2%	36.3%

Legend: d_g – mean quadratic diameter; d_{g20} – mean quadratic diameter of 20% of the largest trees; h_L – Lorey's mean height; h_{g20} – mean height of 20% of the largest trees; N – trees per hectare; G – basal area per hectare; V – wood volume per hectare.

After thinning, which was conducted at the age of 8 years, the number of trees in the experimental plot amounted 204 per hectare, the total basal area $11.15 \text{ m}^2 \cdot \text{ha}^{-1}$, a volume amounted $101 \text{ m}^3 \cdot \text{ha}^{-1}$, which is significantly different from the control plot (Table 2). Mean diameter of the remaining trees increased by 6% compared to the mean diameter of trees on the control plots, but the t-test did not confirm significant differences. Also, there were no significant differences between the diameter and height of the dominant trees, and between height, basal area and volume of mean trees (Table 2).

Based on a detailed analysis of the trees after thinning diameter with bark was obtained as a regression model where independent variable was diameter without bark. Minimum diameters without bark for each assortment are: log for cutting class II - 20 cm, log for cutting class I - 25 cm, log for peeling - 30 cm. The diameters with bark that correspond to the diameters without bark are 20.98 cm, 26.5 cm and 31.9 cm, respectively.

After eight years, nearly 300 trees per hectare on the control plot in plantation had diameter at breast height over 20.98 cm, or from which can be obtained at least one assortment of a log for cutting class II. On the experimental plot after the thinning such trees was 196 per hectare with a volume of $99 \text{ m}^3 \cdot \text{ha}^{-1}$. According to all examined

elements of growth on experimental and control plots (N, G, V) t-test found significant differences (Table 3).

Table 2. Mean values of the growth elements of mean trees in the plantation after 8 years on the experimental and control plots and results of t-test.

Experimental field	d_g [cm]	d_{g20} [cm]	h_L [m]	h_{g20} [m]	g_a [m ²]	v_a [m ³]	N [tree·ha ⁻¹]	G [m ² ·ha ⁻¹]	V [m ³ ·ha ⁻¹]
CP	24,8	30,1	21.06	22.00	0,0482	0,4324	365	17,58	157,68
EP	26,4	29,6	21.42	21.92	0,0547	0,4959	204	11,15	101,21
Ratio	1,06	0,99	1.02	1.00	1,13	1,15	0,56	0,63	0,64
t-test	-3,91	2,52	-1.76	0.35	-3,77	-3,65	21,98	9,98	8,84
p-value	0,0597	0,1276	0.2199	0.7574	0,0637	0,0677	0,0021	0,0007	0,0009

Legend: d_g – mean quadratic diameter; d_{g20} – mean quadratic diameter of 20% of the largest trees; h_L – Lorey's mean height; h_{g20} – mean height of 20% of the largest trees; g_a – arithmetic mean basal area of trees; v_a – arithmetic mean volume of trees; N – trees per hectare; G – basal area per hectare; V – wood volume per hectare.

Table 3. The average values of the growth elements of plantation per hectare after 8 years of trees with diameter at breast height larger than the minimum for the log for cutting class I and II on the experimental and control plots and results of t-test.

Experimental field	(d > 20,98 cm)			(d > 26,5 cm)		
	The assortments: log for cutting class II, log for cutting class I			The assortments: log for cutting class I		
	N [tree·ha ⁻¹]	G [m ² ·ha ⁻¹]	V [m ³ ·ha ⁻¹]	N [tree·ha ⁻¹]	G [m ² ·ha ⁻¹]	V [m ³ ·ha ⁻¹]
CP	294	15,95	144,63	123	8,07	75,10
EP	196	10,90	99,06	101	6,46	59,84
Ratio	0,67	0,68	0,68	0,82	0,80	0,80
t-test	15,00	8,00	7,27	1,25	1,34	1,35
p-value	0,00011	0,00273	0,00362	0,29677	0,26789	0,26284

Legend: N – trees per hectare; G – basal area per hectare; V – wood volume per hectare.

Of this number of trees with diameter at breast height greater than 20.98 cm, on the control plot was found 123 trees and on the experimental plot 101 trees with a diameter at breast height greater than 26.5 cm, which allows making at least one log for cutting class I. The differences between the control and experimental plots are less (about 20%), and t-test did not confirm significant difference between examined elements of growth (Table 3, Figure 1).

After 11 years slightly lower number of trees was found in relation to the state after 8 years on both plots, as a result of mortality of trees and exogenous influences. Basal area on the experimental plot was 16 m²·ha⁻¹, and volume was 153 m³·ha⁻¹, which was 69-70% of the control plot and significantly less by t-test. On both plots it has been found the same dominant diameter, 35.1 cm. However, diameter, basal area and volume of mean tree were significantly higher on the experimental than on the control plot (Table 4).

On both plots similar mean and dominant heights were found, which was confirmed by the t-test. After 11 years on the control plot heights were slightly higher compared to the experimental plot (Figure 2).

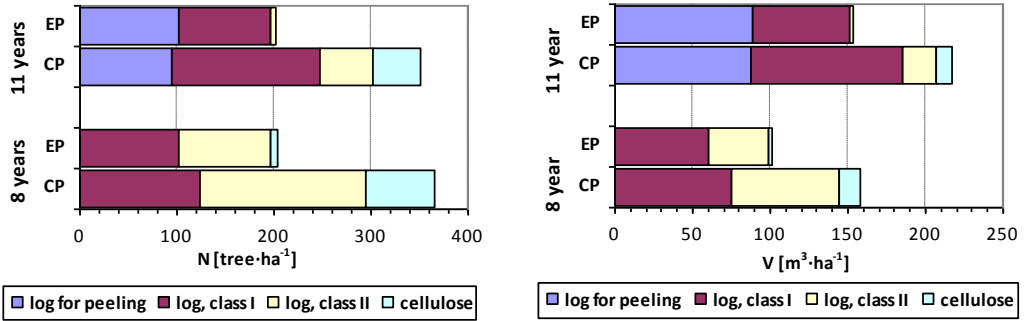
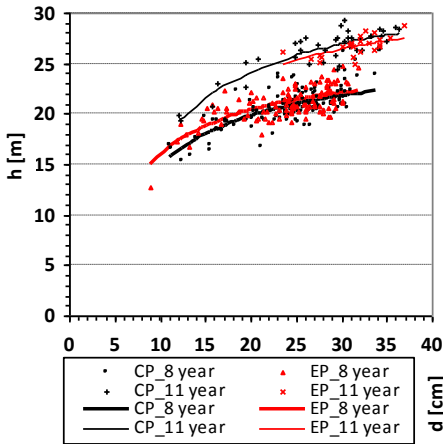

Figure 1. Number of trees (left) and volume (right) per hectare after 8 and 11 years and the participation of various assortments.



Experimental field	Parameters of model: $h = 1.3 + a \cdot e^{b/d}$		Model assessment	
	a	b	R ²	S _e
Control plot, 8 year	25,1382	6,16189	0,4909	1,2762
Experimental plot, 8 year	24,7581	5,24721	0,4787	1,2239
Control plot, 11 year	32,3608	6,93338	0,7893	1,0720
Experimental plot, 11 year	31,6836	6,89586	0,4009	0,7614

Figure 2. Height curves (left) and their model parameters and assessments (right) in experimental and control plantations after 8 and 11 years.

After 11 years on the control plot were found about 250 trees, and on experimental plot about 200 trees per hectare, from which can be obtained at least one assortment log for cutting class I. Significantly higher total number of trees and trees from which can be obtained at least one assortment log for cutting class I caused a significantly higher total basal area and volume per hectare on the control compare to the experimental plot. However, on the experimental plot were found slightly more trees, with a total basal area and volume per hectare which enable production of at least one assortment of a log for peeling compare to the control plot after 11 years (Table 5, Figure 1).

PROCEEDINGS
International Conference **REFORESTATION CHALLENGES**
03-06 June 2015, Belgrade, Serbia

Table 4. Mean values of the growth elements of mean trees in the plantation after 11 years on the experimental and control plots and results of t-test.

Experimental plot	d_g [cm]	d_{g20} [cm]	h_t [m]	h_{g20} [m]	g_a [m ²]	v_a [m ³]	N [tree·ha ⁻¹]	G [m ² ·ha ⁻¹]	V [m ³ ·ha ⁻¹]
CP	28,9	35,1	26.91	27.86	0,0657	0,6184	351	23,07	217,05
EP	31,8	35,1	26.83	27.39	0,0792	0,7592	201	15,96	152,91
Ratio	1,10	1,00	1.00	0.98	1,21	1,23	0,57	0,69	0,70
t-test	-8,08	0,23	1.52	4.11	-7,86	-7,74	15,57	9,00	8,17
p-value	0,0150	0,8417	0.2684	0.0543	0,0158	0,0163	0,0021	0,0014	0,0017

Legend: d_g – mean quadratic diameter; d_{g20} – mean quadratic diameter of 20% of the largest trees; h_t – Lorey's mean height; h_{g20} – mean height of 20% of the largest trees; g_a – arithmetic mean basal area of trees; v_a – arithmetic mean volume of trees; N – trees per hectare; G – basal area per hectare; V – wood volume per hectare.

Table 5. The average values of the growth elements of plantation per hectare after 11 years of trees with diameter at breast height larger than the minimum for the log for cutting class I and log for peeling on the experimental and control plots and results of t-test.

Experimental plot	(d > 26,5 cm) The assortments: log for cutting class I, log for peeling			(d > 31,9 cm) Sortiment: log for peeling		
	N [tree·ha ⁻¹]	G [m ² ·ha ⁻¹]	V [m ³ ·ha ⁻¹]	N [tree·ha ⁻¹]	G [m ² ·ha ⁻¹]	V [m ³ ·ha ⁻¹]
CP	248	19,32	184,76	95	8,90	87,28
EP	196	15,70	150,58	101	9,13	89,01
Ratio	0,79	0,81	0,82	1,06	1,03	1,02
t-test	4,84	4,27	4,12	-0,45	-0,19	-0,15
p-value	0,01849	0,01316	0,01465	0,69478	0,86204	0,89051

Legend: N – trees per hectare; G – basal area per hectare; V – wood volume per hectare.

Table 6. Average values of current increment of mean tree growth elements in the plantation during the period from 8 to 11 years of the experimental and control plots and results of t-test.

Experimental plot	i_d [cm·year ⁻¹]	i_{d20} [cm·year ⁻¹]	i_h [m·year ⁻¹]	i_{h20} [m·year ⁻¹]	i_g [m ² ·year ⁻¹]	i_{g20} [m ² ·year ⁻¹]	i_v [m ³ ·year ⁻¹]	i_{v20} [m ³ ·year ⁻¹]	i_v [m ³ ·ha ⁻¹ ·year ⁻¹]
CP	1,35	1,70	1.90	1.96	0,0059	0,0088	0,0623	0,0971	19,79
EP	1,82	1,81	1.81	1.79	0,0083	0,0092	0,0886	0,1011	17,23
Ratio	1,35	1,06	0.95	0.91	1,41	1,05	1,42	1,04	0,87
t-test	-28,65	-1,68	1.46	1.98	-22,35	-1,03	-20,49	-0,87	2,94
p-value	0,0012	0,2355	0.2819	0.1867	0,0020	0,4109	0,0024	0,4769	0,0468

Legend: i_d – current diameter increment of mean tree; i_{d20} – current diameter increment of 20% of the largest tree; i_h – current height increment of mean tree; i_{h20} – current height increment of 20% of the largest tree; i_g – current increment of basal area of mean tree; i_{g20} – current increment of basal area of 20% of the largest tree; i_v – current increment of volume of mean tree; i_{v20} – current increment of volume of 20% of the largest tree; i_v – current increment of volume per hectare.

Current increment of diameter, basal area and volume of mean tree in the period from 8 to 11 years were significantly higher for 35-42% in the experimental than in the control plot. Current increment of diameter, basal area and volume of dominant tree are higher for 4-6% in the experimental compared to the control plot, which was not significant (Table 6). However, current height increment of mean and dominant tree is smaller for 5-9% in the experimental than in the control plot.

The current volume increment per hectare for a period of 8-11 years was lower by $2.5 \text{ m}^3 \cdot \text{ha}^{-1} \cdot \text{year}^{-1}$ on the experimental compared to the control plot which is, by the t-test, a significant difference.

DISCUSSION AND CONCLUSIONS

Habitat is a factor that determines the characteristics of tree growth and the level of productivity of stands (plantations), and also intensity of reaction of trees on implemented thinnings. The achieved growth elements, primarily the dominant and mean height at a certain age, indicate that investigated plantation is on the medium favorable habitat for growing poplar (Andrašev 2008, Pudar 1986, Marković et al. 1997a), so average increment of growth elements of trees was expected on the experimental area.

Considering a high current increment of height and diameter of mean tree in the period of 3-8 years (Andrašev et al. 2011) thinning carried out after eight years can be characterized that it was conducted in the optimal period, which, according to the Stanturf et al. (2001) and Krinard, Johnson (1980), provides a good basis for a favorable reaction of trees in increment by increasing space for growth. Conducted thinning was heavy by intensity, and low by character which conditioned that the collective of remaining trees had more uniform size (diameter, height, size of canopy) compared to the collective of trees on the control plot, so were expected higher production and better quality assortments.

Results of the research indicate that the reaction of trees on the conducted thinning on experimental plot for a period of three years was the biggest in terms of increasing diameters at breast height (35%), basal areas (41%) and volumes (42%) of mean trees. Reaction to the thinning is slightly smaller on a diameter of dominant trees, compared to mean trees, while increasing the heights of dominant and mean trees were smaller compared to the control plot. These results are in agreement with the results of Andrašev et al. (2012) which stated reaction of poplar trees, clone I-214, in the five-year period on a heavy, low thinning in a plantation with wide spacing where also was found the largest increase of mean tree diameter by 40%. Those authors were given greater height increments on the control plot compare to the experimental plot (significant differences in a dominant trees), which is consistent with our results.

Conducted thinning after eight years was homogenized the collective of remaining trees of which 96% had diameters which enable production of at least one log for cutting class II and 50% enable production of at least one log for cutting class I, while on the control plot stated participation of trees were 81% and 34%, respectively. Larger diameter increment of trees in the experimental plot in the period from 8 to 11 years

caused the same number of trees per hectare which enable production of at least one log for peeling on experimental and control plots in 11 years, which in relative terms is 50% of on experimental and 27% on the control plot.

Poplars, as fast-growing species in our climate, strongly react to the regulation of growing space. The results show that the effects of thinning manifested in larger increment in diameter, basal area and volume of the mean tree, as well as larger relative share of higher quality assortments in the experimental compared to the control plot, already after three years.

Acknowledgement: *This paper was realized as a part of the project „Studying climate change and its influence on the environment: impacts, adaptation and mitigation“ (43007) financed by the Ministry of Education and Science of the Republic of Serbia within the framework of integrated and interdisciplinary research for the period 2011-2014.*

REFERENCES

- Andrašev S. (2008). Razvojno proizvodne karakteristike selekcionisanih klonova crnih topola (sekcija *Aigeiros* DUBY) u gornjem i srednjem Podunavlju. Disertacija, Šumarski fakultet Univerziteta u Beogradu, p. 427.
- Andrašev S., Bobinac M., Rončević S., Stajić B., Janjatović G. (2011). Properties of thinning applied to a stand of poplar clone B-229 (*Populus deltoides* Bartr. ex Marsh.) established in lower Srem. *Poplar*, 187/188: 99-121. (in Serbian with English summary)
- Andrašev S., Bobinac M., Rončević S., Vučković M., Stajić B., Janjatović G., Obućina Z. (2012). Effects of thinning in a plantation of poplar clone I-214 with wide spacing. *Šumarski list*, 1-2: 37-56. Zagreb
- Krinard R.M., Johnson R.L. (1980). Fifteen years of cottonwood plantation growth and yield. *South. J. Appl. For.* 4(4):180–185.
- Marković J., Pudar Z., Rončević S. (1994). Efekti proreda u nekim zasadima topola. Zbornik radova sa zaključcima savetovanja 'Uzgojno-biološki i ekonomski značaj proreda u šumskim kulturama i mladim šumama'. Javno preduzeće za gazdovanje šumama 'Srbijašume', Beograd. (107-122).
- Marković J., Rončević S., Andrašev S. (1997a). Osnovne karakteristike razvoja nekih novih klonskih sorata topola. *Savremena poljoprivreda* 3-4: 124-130.
- Marković J., Rončević S., Pudar Z. (1997b). Izbor razmaka sadnje pri osnivanju zasada topola. *Topola* 159-/160: 7-28.
- Marković J., Rončević S., Andrašev S. (1998). Poplar biomass production depending on the clone and planting space. 10th European Conference and Technology Exhibition 'Biomass for Energy and Industry', Würzburg. *Proceedings* 1078-1081.
- Marković J., Rončević S., Andrašev S. (2001). Effect of plantation density on the production of poplar biomass *Populus deltoides* Bartr. Third Balkan Conference 'Study, conservation and utilisation of the forest resources' Sofia. *Conference Proceedings*, Vol I: 435-443. 15
- Pap P., Stojnić S., Vasić V., Janjatović G., Obućina Z. (2009): Proizvodnja i zaštita topola u rasadnicima i matičnjacima Šumskog gazdinstva "Sremska Mitrovica" u periodu 2003-2008. godine. *Šumarstvo*, 3-4: 153-168, Beograd.

- Pudar Z. (1986). Ekonomski aspekti proizvodnje drveta topole, *Populus × euramericana* (Dode) Guinier, cl. I-214 u zasadima različite gustine. Radovi Instituta za topolarstvo, 17: 1-121, Novi Sad.
- Stanturf J.A., van Oosten C., Netzer D.A., Coleman M.D., Portwood C.J. (2001). Ecology and silviculture of poplar plantations. In Poplar Culture in North America. Part A, Chapter 5. Edited by D.I. Dickmann, J.G. Isebrands, J.E. Eckenwalder, and J. Richardson. NRC Research Press, National Research Council of Canada, Ottawa, ON KIA OR6, Canada. pp. 153-206.
- Škorić A., Filipovski G., Ćirić M. (1985). Klasifikacija zemljišta Jugoslavije. Akademija nauka i umjetnosti Bosne i Hercegovine; Posebna izdanja, knjiga LXXVIII; Odeljenje prirodnih i matematičkih nauka, knjiga 13: 1-72, Sarajevo.

GENERAL OVER-VIEW OF FOREST ESTABLISHMENT IN TURKISH FORESTRY

Nebi Bilir* and Suleyman Gulcu

*Corresponding author: email: nebibilir@sdu.edu.tr or nebilir@hotmail.com

Bilir N., Gulcu S. (2015). General over-view of forest establishment in Turkish forestry. In: Ivetić V., Stanković D. (eds.) Proceedings: International conference Reforestation Challenges. 03-06 June 2015, Belgrade, Serbia. Reforesta. pp. 159-163.

Abstract: Turkey has 21.6 million hectares forest area of which 46.7% (10.1 million ha) is unproductive. Forest establishment including afforestation, reforestation, artificial regeneration, rehabilitation and private plantation is the most important way in conversion of unproductive forest to productive. They are examined based on Turkish forest inventory between 1946 and 2013. Seed and seedling productions are also examined for forest establishment in the paper.

About 2.2 million ha area was afforested in Turkey according to inventory of between 1946 and 2013. The afforestation was also supported by 2.5 million ha based on “National Afforestation and Erosion Control of Campaign” between 2008 and 2012. Beside, 121582 ha private forest was established by local people in unproductive forest area between 1985 and 2013. According to inventory of between 1946 and 2013, about 0.8 million ha artificial regeneration and 0.8 million ha rehabilitation were also carried out. Beside, 4 million ha forest was established or improved based on the inventory. 14 billion seedlings and 8 thousand tones seeds were used in the establishment. Present forest establishment was summarized based on inventorial data to discussion for future establishment.

Keywords: Afforestation, challenge, reforestation, regeneration, plantation, inventory.

TURKISH FORESTRY

Turkey has 21.6 million hectares forest area of which 46.7% of the area (10.1 million ha) is unproductive (Figure 1, www.ogm.gov.tr, 2014). Productivity is determined by degree of crown closure in Turkish forestry. General inventory of forest area of Turkey is given for some years in Table 1 (www.ogm.gov.tr, 2014; Anonymous, 2014).



Figure 1. Forest area of Turkey.

PROCEEDINGS

International Conference **REFORESTATION CHALLENGES**

03-06 June 2015, Belgrade, Serbia

Table 1. General inventory of forest area of Turkey for some years.

Years of inventory	Productive		Unproductive		Total ha
	ha	%	ha	%	
1963-1972	8.856.457	44	11.342.839	56	20.199.296
1973-1999	10 027 568	49	10 735 680	51	20 763 248
2000-2009	10 972 509	51	10 417 274	49	21 389 783
2009-2013	11.558.668	53.3	10.119.466	46.7	21.678.134

While the forest area covers 27.6% of Turkey according to inventory of 2013, it was 26.1% in inventory of 1973 (Table 1). There are 28 coniferous (11.1 million ha, 54%), and about 70 broadleaves (9.6 million ha, 46%) in Turkey (www.ogm.gov.tr, 2014). They are mainly *Pinus brutia* (5.9 million ha), *Quercus sp.* (5.2), *Pinus nigra* (4.7), *Fagus orientalis* (1.9), *Pinus sylvestris* (1.5) and *Juniperus sp.* (0.6). Some exotic species were also tested for plantation. They were *Larix sp.*, *Pinus pinaster*, *P. contorta*, *P. radiata*, *P. elderica*; *Picea abies*, *P. sitchensis*; *Pseudotsuga sp.* and *Eucalyptus sp.* About all forest area are managed by General Directorate of Forestry of Ministry of Forestry and Water Affairs. Annual increment is about 3 m³/ha. Annual production: 16.9 million m³ (www.ogm.gov.tr, 2014).

FOREST ESTABLISHMENT

Forest establishment is the most important way in conversion of unproductive forest to productive or increasing of forest land by afforestation, reforestation, artificial regeneration and rehabilitation Forest establishment inventory of Turkey for some years is presented in Table 2. A variety of definitions differentiate between afforestation and reforestation. Reforestation refers to establishment of forest on land that had recent tree cover, whereas afforestation refers to land that has been without forest for much longer (Figure 2).

Table 2. Forest establishment inventory of Turkey for some years.

Years of inventory	Afforestation*	Reforestation	Artificial regeneration	Private afforestation	Rehabilitation	Total
1946-1991	1.465.999	50.047	449.258	3.378	-	1.968.682
1992-1995		115.486	90.525	2.905	-	208.916
1996-1999		107.446	92.044	13.765	11.874	225.129
2000-2003		115.727	53.047	13.830	17.871	200.475
2004-2007		99.022	52.268	38.319	712.109	901.718
2008-2011		168.160	52.491	44.441	52.491	317.583
2012		42.009	12.958	4.944	347.719	407.630
2013		46.656	8.921	1.975	106.182	163.734
TOTAL	2.121.887		789.633	121.582	794.345	3.827.447

*Inventory of afforestation and reforestation was combined by Ministry of Forestry after 1991.

The first afforestation of Turkey was established at 2-2.5 ha in Istanbul in 1892. The main afforestation was started in 1916 and 1925. The first forest nursery was also established in Ankara in 1925. The first larger afforestation was carried out in southern part of Turkey at 850 ha by *Eucalyptus sp.* in 1939. Average of annual afforestation was

PROCEEDINGS

International Conference **REFORESTATION CHALLENGES**

03-06 June 2015, Belgrade, Serbia

32500 ha, while it varied between 478 and 120000 ha according to Turkish forest inventory between 1946 and 2013. The present afforestation was also supported 2.5 million ha based on “National Afforestation and Erosion Control of Campaign” by private and governmental foundations between 2008 and 2012. Two billion seedlings and 3.8 tons seed were used in different forest tree species in the Campaign (www.cem.gov.tr, 2014).

Reforestation practices were started in out of forest area by 1261 ha in 1949. It was combined by afforestation in forest inventory after 1991(www.ogm.gov.tr, 2014).

The both afforestation and reforestation practices were also supported by artificial regeneration and rehabilitation in degraded/unproductive areas (Figure 3). While artificial regeneration was started in 1973, it was 1998 for rehabilitation. Rehabilitation area was generally applied in non-forest tree land and disadvantages land in forest area. Rehabilitation needed more intensive forestry practices than that of artificial regeneration. Beside, 121582 ha private forest was established by local people in unproductive forest area between 1985 and 2013 (www.ogm.gov.tr, 2014).



Figure 2. A general view from reforestation (left side) and afforestation (right side)



Figure 3. A general view from artificial regeneration (left side) and rehabilitation (right)

All forest establishments are carried out by sowing or planting, and also their combinations (Figure 4).



Figure 4. A general view from sowing (left side) and planting (right side)

SEED AND SEEDLING PRODUCTIONS

Turkey has 172 seed orchards established by 6476 clones at 1190 ha of ten tree species mainly Turkish pines (*Pinus brutia*, *P. nigra* and *P. sylvestris*). For instance, 68 of the orchards were established by 3026 clones at 479 ha in *Pinus brutia*.

347 seed stands of 24 species of which four exotic (*Pinus radiata*, *P. pinaster*, *Eucalyptus* and *Robinia pseudoacacia*) were selected at 46390 hectares. 283 of the stands at 39472 ha were selected in coniferous. 161 of the stands at 22600 ha were selected in *Pinus brutia* and *P. nigra*. 7037 plus trees were selected in ten species. Seed transfer zones were also prepared in six species (*Pinus brutia*, *P. nigra*, *P. sylvestris*, *Picea orientalis*, *Cedrus libani* and *Fagus orientalis*) (www.ortohum.gov.tr, 2013).

14 billion seedlings and 8 thousand tones seeds were used in the establishment of 4 million ha forest (Figure 5). Annual averages of seedling and seed production were 300 million and 400 tones, respectively. Seedling and seed productions were generally on coniferous such as *Pinus brutia*, *P. nigra* and *Cedrus libani*. Seedling and seed productions were presented in Table 3 for last decade (www.cem.gov.tr, 2014).



Figure 5. A view from seedling production for forest establishment.

Table 3. Seedling and seed productions for last decade.

	2004	2005	2006	2007	2008	Years		2010	2011	2012	2013	Total
						2009						
Seedlings												
X1000	200.495	250.209	350.551	400.000	389.669	436.764	424.523	509.447	471.157	401.300	3.834.115	
Seed (t)	359	350	711	520	813	801	653	563	982	600	6.352	

CHALLENGES IN FOREST ESTABLISHMENT

Protection is one of the most important problems in governmental forests (Figure 6). About all Turkish forest are governmental forests. Geographic characters have important roles in biological and economical success in forest establishment such as mechanical establishment (Figure 6). Large of unproductive area is not getting easy in organization and financial support of forest establishment. Some exotic species can be unsuccessful in future years.



Figure 6. A view from protection (left side) and geographic challenges (right side)

CONCLUSION

Physiological and morphological should be combined especially for disadvantages areas (i.e., arid area) in economical and biological success of forest establishment. Forest establishment should be organized for small areas. Private forestry should be supported financially. Forest establishment should be also carried out by private companies. Local seed sources should be used in local forest plantation. Seed transfer zones should be taken into consideration in determination of seed sources in forest establishment.

REFERENCES

- Anonymous, 2014. Forest Inventory of Turkey. General Directorate of Forestry. Ankara, Turkey.
www.ogm.gov.tr, 2014. Website of General Directorate of Forestry of Turkey, Ankara, Turkey.
www.ortohum.gov.tr, 2013. Website of the Research Directorate of Forest Tree Seeds and Tree Breeding of Turkey, Ankara, Turkey.
www.cem.gov.tr, 2014. Website of General Directorate of Combating Desertification and Soil Erosion of Turkey, Ankara, Turkey

FIELD PERFORMANCE OF *FRAXINUS ORNUS* BAREROOT PLANTS TO DROUGHT STRESS

Rahman M.S., Tsitsoni T., Tsakaldimi M*., Ganatsas P.

*Corresponding author: marian@for.auth.gr

Rahman M.S., Tsitsoni T., Tsakaldimi M., Ganatsas P. (2015). Field performance of *Fraxinus ornus* bareroot plants to drought stress. In: Ivetić V., Stanković D. (eds.) Proceedings: International conference Reforestation Challenges. 03-06 June 2015, Belgrade, Serbia. *Reforesta*. pp. 164-174.

Abstract: In this study an experiment was conducted to find out the influence of drought on *Fraxinus ornus* plant morphology, biomass allocation, architecture of first-order lateral roots (FOLR) and field survival at the early stages of outplanting. Totally 120 undercut bareroot plants were transplanted to field conditions in a Mediterranean area. After establishment, half of the seedlings were kept well-watered (control) while the rest received no other irrigation except natural rainfall (water stress). In the field, measurements were taken after 6 months (before summer), after 8 months (midsummer) and after 10 months (after summer). The results showed that the root biomass, the seedling quality index and the number of first order lateral roots were significantly greater in watered seedlings. The mean length of FOLR increased over time in watered and stressed seedlings as well. However, after the summer period the stressed seedlings had also significantly lower length of FOLR than watered ones. Similarly, the leaf RWC was highly affected by the treatments applied and was found significantly greater in water seedlings during the summer. The first summer period after outplanting was crucial for stressed and watered seedlings as well. Eight months after outplanting the survival rate of stressed seedlings was 45% while that of well-watered seedlings was 75%. There is much evidence for the positive relationship between root biomass, seedling quality index and number and length of FOLR with seedlings survival.

Keywords: biomass, *Fraxinus ornus*, Mediterranean, root architecture, survival, water stress.

INTRODUCTION

Seedling establishment in the field is very important because in this stage, rate of failure is high in many species (Tsakaldimi et al. 2013). Seedlings of many species die due to various causes such as high or low temperature, transplanting shock, low soil moisture, competition, allelopathy, etc. Especially, in Mediterranean areas, the planting stock is very drought sensitive and the establishment process is often limited to irregular rainfall (Holmgren and Scheffer 2001; Valdecantos et al. 2006). Thus, it is important to assess drought responses of whole seedling i.e. survival and growth under water stress compared

to well-watered individuals. The quick root growth and the survival of a seedling mainly depend on how its root system is at the time of outplanting. To use bareroot seedlings, sufficient root systems along with large first order lateral roots (FOLR) that grow from the central root should be ensured in order to achieve high field performance (Thompson and Schultz 1995). After field planting, seedlings are generally exposed to extreme temperature, wind, drought, low humidity and other adverse conditions. Under such conditions, transpiration of the seedlings occurs very rapidly but the seedlings do not get enough soil moisture. As a result, seedlings get transplanting shock and their establishment and survival are encountered serious problem (Zaady and Perevolotsky 1995; Ffolliott et al. 2003).

In Mediterranean climates the severe drought period lasts from June to September and during these months the temperature is very high. This post-planting period negatively affects the success of seedling field establishment (Ganatsas et al. 2012). However, the degree of tolerance to drought varies from species to species and this variation may be helpful to choose species for planting in the drought prone areas (Gindaba et al. 2004). The establishment of seedlings in the field depends on their morphological and physiological characteristics, and the environmental conditions of the planting site (Puttonen 1996, Tsakaldimi et al. 2013). There are various morphological and physiological methods to test the seedling quality before and after field plantation (Mattsson 1997). Among them, measurements of shoot and root morphological growth parameters are easily and commonly used to determine the seedling quality (Rose et al. 1990, Puttonen 1996, Tsakaldimi et al. 2013). The study of root morphology is necessary to analyze the response of the seedling in the water stress condition. Also, leaf relative water content has been used to measure the plant water condition in terms of cellular hydration under the possible effect of leaf water potential and osmotic adjustment (Kramer and Boyer 1995, Gindaba et al. 2004). Though many studies were conducted in the field condition, those were mainly on above ground morphology or physiology (e.g. Roy et al. 2001, Jacobs et al. 2005, Wilson et al 2007). Few studies were reported on morphology and architecture of the whole seedlings including root systems in relation to field performance (e.g. Dey and Parker 1997, Martínez-Sánchez et al. 2003, Tsakaldimi et al. 2009, Tsakaldimi et al. 2013) and even less in relation to water stress (Padilla and Pugnaire 2007, Zida et al. 2008). Such studies are helpful to find out promising species for reforestation as well as restoration programs in Mediterranean areas where water deficit is common.

The present study was undertaken to find out the influence of drought on *Fraxinus ornus* L. (Manna Ash) plant morphology, biomass allocation, architecture of first-order lateral roots (FOLR), and field survival at the early stages of outplanting. Moreover, seasonal variation of soil available moisture was also evaluated.

MATERIALS AND METHODS

Fraxinus ornus L. (Oleaceae family) is a plant species native to southern Europe and southwestern Asia, from Spain and Italy north to Austria, Poland and the Czech Republic, and east through the Balkans, Turkey, and western Syria to the Lebanon. This

species selected as it is known that it has not been affected much from climate changes and it possess tolerance against drought (Yücedag and Sen 2008). Three years old bareroot seedlings of *Fraxinus ornus* were lifted from an open- air nursery of the Forest Service Department of Thessaloniki, northern Greece. After lifting, the root systems of the seedlings were undercut. Thirty undercut seedlings were taken randomly (Zida et al. 2008) for initial morphology and biomass measurements. The field experiment was conducted at the Arboretum of the Lab. of Silviculture, AUTH, Greece (longitude 23°08'13.23" E, latitude 40°30'50" N, altitude 123 m) on November 2011. The climate of the area is typical Mediterranean with hot dry summers and cool winters. In 2011 and 2012, mean annual precipitation was 484 mm and 498 mm respectively, while the days of rainfall were totally 91 and 96 respectively. There was no rain in July 2011 and there was only one day of rainfall in June 2012. The climatic data were derived from the weather station (Forest Research Institute, Vasilika, northern Greece) near the experimental field.

The experiment was laid out as a randomized complete block design with two treatments and three replications; 20 seedlings of same age and similar size x 3 replications x 2 treatments (120 seedlings totally) were outplanted in pits (0.3 m x 0.3 m). After establishment, half of the seedlings were kept well-watered (control) where the soil was maintained at field capacity, by regular irrigation which was applied daily, while the rest received no other irrigation except natural rainfall (water stress). Planting distance was 2m x 2m. Buffer zones of 3m were created to separate the experimental units. All seedlings were hand- planted with planting shovel and spade and no fertilization was applied. To hold rain water, a boundary of soil was made around the seedling of a pit. The spot weeding was done around the seedlings when needed. Field measurements were taken 6 months after planting (before summer), 8 months (midsummer) and 10 months (after summer). Leaf relative water content (RWC) was determined on 10 discs (4 mm size) per treatment from the leaves similar in age and orientation. All leaf disk samples were taken at the noon on uppermost fully expanded leaves from three seedlings (one from each replication) of each treatment. Then they put into polythene bags and they were transferred to the laboratory inside a mini refrigerator. The leaf RWC was calculated according to Iannucci et al. (2000). For each harvest period, 12 seedlings (4 seedlings x 3 replications) per treatment were randomly chosen and excavated for the root morphology by the total excavation method (Martínez-Sánchez et al 2003, Tsakaldimi et al. 2009), shoot morphology and biomass measurements. Before excavation, sufficient water was poured around the seedling to loose and wet the soil. In the laboratory, roots and soil were repeatedly submerged in water. A sieve was used to collect any root fragments detached from the system. Then seedlings with their whole root system were kept in polythene bags and stored in the fridge for further measurements. Seedling parameters measured were: height, root collar diameter, sturdiness index (H/D), length of central root, number of living branches, shoot and root dry weight and seedling quality index (QI) calculated using the equation (Dickson et al. 1960): $QI = \frac{\text{total seedling dry weight (g)}}{[\text{height (cm)} / \text{diameter (mm)} + \text{shoot dry weight (g)} / \text{root dry weight (g)}]}$. Also, the first-order lateral roots (FOLR, $d \geq 1$ mm) were counted and their length and diameter were measured (Dey and Parker 1997). Then, each FOLR was categorized into five different diameter classes D1 (1-2 mm), D2 (2-3 mm), D3 (3-4 mm), D4 (4-5 mm) and D5 (>5 mm).

Survival rate of seedlings was recorded during 17 months after transplantation. After 10 months in the field, the plants of both treatments were left in same natural environment without irrigation. In addition, from June to September 2012, soil samples were collected from 3 points of equal distance from the centre of each replication and from three different soil depths viz. 0-20 cm, 20-40 cm, and 40-60 cm, in order to measure the available soil moisture in each treatment. Soil moisture was calculated as follows: soil available moisture % = $(B1-B2)/B2 \times 100$, where B1: the initial soil weight and B2: oven-dried soil weight at 105° C. All statistics were calculated by SPSS software. Distribution was tested for normality by Kolmogorov–Smirnov criterion and the homogeneity of variances was tested by Levene’s test. Two samples Independent t-test was conducted to compare the means of seedlings parameters.

RESULTS AND DISCUSSION

Plant morphological characteristics

Shoot height of *F. ornus* decreased over time and it did not vary significantly among survived seedlings of control and water stress treatment in the field (Table 1). This happened due to the shoot top drying which was observed during the summer months, while the stressed seedlings showed more shoot drying than watered ones. Probably, the survived seedlings started to be adapted in the field by reducing their above ground transpiration area. Planting seedlings with great height and transpiration area may be a disadvantage for dry sites that leads to poor field growth or death (Haase 2007). Some shoots of seedlings completely died back and new coppice shoots grew from the soil level. Dey and Parker (1997) also reported partial shoot dieback of bareroot red oak species, followed by less height and formation of lateral shoots after planting in dry sites. Similarly, Schultz and Thompson (1997) studied undercut bareroot seedlings and found that height and diameter growth was hampered by stem dieback on the largest seedlings. Root collar diameter of seedlings was also not affected by drought. Similarly, the sturdiness ratio (H/D) did not vary significantly between the two water regimes even though it was found slightly lower in stressed seedlings. Roller (1977) found that black spruce seedlings with high sturdiness quotients were more susceptible to damage from wind, drought, and frost exposure.

The number of branches did not increase during six months after outplanting. New branches appeared after 8 months in both water regimes and they significantly varied due to water stress treatment. The central root, six months after outplanting, was 5 cm longer than the initial central root but this difference was not statistically significant. After applying the water stress treatment, the central root length of stressed seedlings was significantly shorter than that of control ones. However, two months later, alive stressed seedlings increased their central root more (104.9%) to become statistically similar with those of control ones. Gazal et al. (2004) reported longer tap roots of *Pterocarpus indicus* seedlings at lower moisture levels (75% and 50% of field capacity) instead of 100% field capacity.

PROCEEDINGS
International Conference **REFORESTATION CHALLENGES**
03-06 June 2015, Belgrade, Serbia

Table 1. Morphological characteristics of shoot and root of *Fraxinus ornus* seedlings at two water regimes during 10 months in the field.

Months after outplanting	Treatment	Shoot height: H (cm)	Root collar diameter: D (mm)	Number of branches	Sturdiness ratio (H/D)	Length of central root
0	-	177.1±5.0 ^{ns}	11.1±0.2 ^{ns}	1.4±0.3 ^{ns}	16.2±0.5 ^{ns}	18.6±0.9 ^{ns}
6	-	174.4±4.6 ^{ns}	11.5±0.2 ^{ns}	1.5±0.3 ^{ns}	15.3±0.3 ^{ns}	23.8±4.6 ^{ns}
8	Control	162.7±8.9 ^{ns}	12.4±0.6 ^{ns}	5.4±0.6 ^a	14.0±0.9 ^{ns}	36.0±3.3 ^a
	Stressed	143.8±11.1 ^{ns}	12.0±0.9 ^{ns}	3.4±0.6 ^b	12.4±0.7 ^{ns}	20.6±1.3 ^b
10	Control	161.9±8.7 ^{ns}	12.2±0.6 ^{ns}	4.9±0.8 ^{ns}	13.7±0.6 ^{ns}	43.3±6.1 ^{ns}
	Stressed	142.4±14 ^{ns}	10.9±0.9 ^{ns}	3.4±0.9 ^{ns}	13.1±0.7 ^{ns}	42.17±4.1 ^{ns}

Values are means ± S.E. Different lower case letters (a, b) show significant differences ($P < 0.05$) between 0 and 6 months or between the two treatments within the same time and column. ns: non significant.

Biomass allocation

The shoot biomass of seedlings was not affected by drought as a result of the shoot die back and the new leaves development in the lower part of shoot, which were common in seedlings of both treatments (Table 2). On the contrary, the stressed seedlings presented significantly lower root biomass than control ones. However, the shoot/root ratios that show the balance between the transpiration area and the water absorbing area of the seedlings (Hermann 1964, Haase 2007) were found statistically similar between watered and stressed seedlings. This may be resulted from the fact that while the roots of stressed seedlings dried and became inactive, on the other hand the shoots' dieback and leaves' damage due to excessive sunlight, in both treatments, increased. According to the values of Dickson quality index, the drought significantly affected the quality of survived bare-rooted seedlings. After applying the water stress treatment (8 and 10 months after outplanting), the stressed seedlings showed significantly lower quality than watered ones. It is evident that the lower root dry weight has contributed to this reduction.

Table 2. Biomass allocation and seedling quality index of *F. ornus* seedlings in different times and water regimes in the field.

Months after outplanting	Treatment	Shoot dry weight (g)	Root dry weight(g)	Total biomass (g)	Shoot/root ratio	Quality Index (QI)
0	-	17.3±0.8b	11.8±0.8b	29.1±1.4b	1.6 ±0.0b	2.6±0.2b
6	-	88.7±31.0a	31.7±10.2a	120.4±40.8a	2.7±0.3a	8.2±3.2a
8	Control	113.4±16.4ns	51.6±7.4a	165.0±23.1a	2.3±0.1ns	11.8±1.4a
	Stressed	71.1±13.7ns	28.2±4.8b	99.3±17.5b	2.6±0.3ns	7.0±1.2b
10	Control	109.3±20.3ns	49.1±8.1a	158.3±27.9ns	2.3±0.2ns	10.0±1.8a
	Stressed	69.6±14.3ns	29.2±5.6 b	98.8±19.7ns	2.4±0.2ns	6.6±1.4 b

Values are means ± S.E. Different lower case letters (a, b) show significant differences ($P < 0.05$) between 0 and 6 months or between the two treatments within the same time and column. ns: non significant.

Architecture of FOLR

Many authors argue that FOLR could be one of the best field predictors of field response and competitive capacity of planted seedlings (e.g. Teclaw and Isebrands 1993, Kormanik et al. 1995, Jacobs et al. 2005, Grossnickle 2005, Tsakalidimi et al. 2013). These roots provide the structural framework of the root system and are active in water and nutrient uptake. When irrigation was withdrawn and air temperature was increasing, mean number of FOLR increased significantly in control seedlings at 8 and 10 months after transplantation compared to stressed seedlings, although the latter showed a tendency to increase their number of FOLR (Figure 1). Diameter class-wise analysis showed that the number of FOLR was greater at the lower diameter classes than at the higher diameter classes (Figure 2) and this trend was observed both in watered and stressed seedlings. This may be attributed to the increase of the newly grown (thinner) roots. Mean length of first order lateral roots increased over time (Figure 3A). Although watered and stressed seedlings showed statistically similar mean length of FOLR after 8 months, 2 months later watered seedlings had significantly longer FOLR than stressed ones. Interestingly the mean diameter of FOLR decreased from 8 months to 10 months period in both water regimes (Figure 3B). This probably happened because the old roots gradually dried and the new ones (thinner) started to grow. The increase of the length of FOLR in expense of their diameters especially for the stressed seedlings may be one the adaptive mechanisms of these seedlings in dry Mediterranean site.

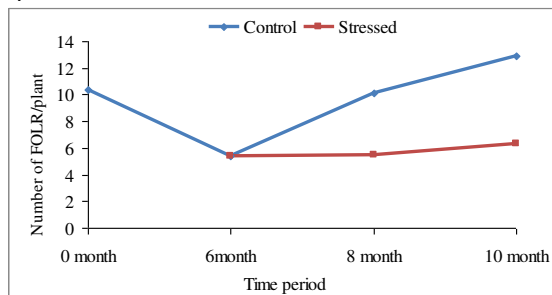

Figure 1. Total number of FOLR (diameter $\geq 1\text{mm}$) per plant in two water regimes and at different time period after field transplanting.

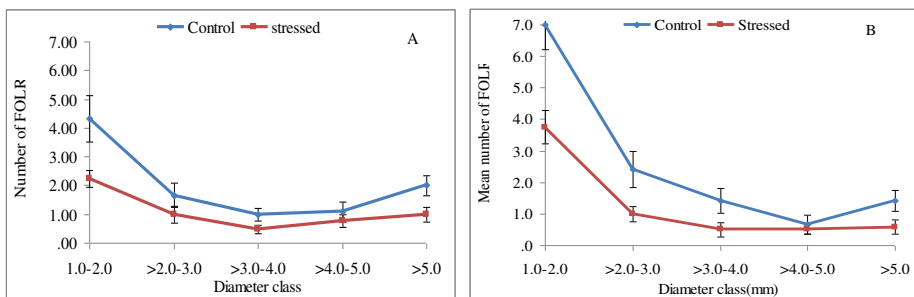

Figure 2. Number of FOLR per plant according to five diameter classes in two water regimes after 8 months (A) and 10 months (B).

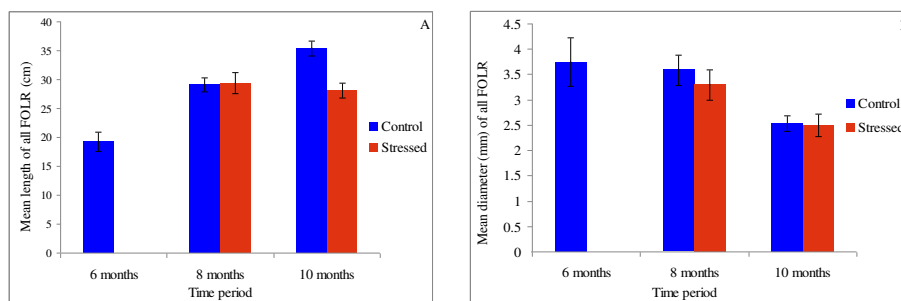

Figure 3. Mean length (cm) (A) and mean diameter (mm) of all FOLR (B) of *F. ornus* bareroot seedlings in two water regimes at different time period.

Leaf Relative water content (RWC)

The leaf RWC of plants was significantly affected due to the drought treatment during the summer period (June and July 2012). Thus, control (watered) seedlings had significantly higher RWC than stressed ones in all studied dates (Figure 4). However, even within the treatment, the RWC varied with the time because of the soil moisture and temperature fluctuation. In stressed plants, the lack of water caused a marked dehydration of the leaves. Similar results were reported by Rahman et al. (2013) for *Cercis siliquastrum* bareroot seedlings. Medrano et al. (1992) also reported low values of water parameters in plants subjected to drought. The maintenance of high leaf RWC has often been suggested as an indicator of drought resistance mechanism in seedlings under dry soils (Iannucci et al. 2000). Also, the ability of plant to recover rapidly after stress condition can be related to its physiological tolerance to drought (Ludlow and Muchow 1990).

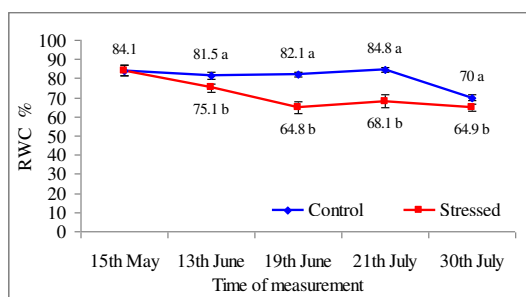

Figure 4. Effect of drought on leaf RWC of *F. ornus* plants at different time periods in the field. Different lower case letters (a, b) show significant differences ($P < 0.05$) between the treatments.

Soil moisture fluctuation

The applied treatments greatly affected soil moisture; thus, the soil moisture content of control treatment was higher in all dates compared to the stressed treatment,

due to additional water given to control (Table 3). As a consequence the soil moisture content in stressed plots was found low (almost less than 8%) for the whole summer period. The lowest value was observed on 30th July 2012 (5.56% in a depth of 0-20 cm), attributed to high temperatures and prolonged dry period. The soil moisture content in the control plots ranged between 19-25% for the whole summer period, while the lowest value (18.8%) was found on 1st July 2012. Soil moisture content of the deeper layers (20-40 cm and 40-60 cm) was slightly higher than of the top soil in all cases.

Table 3. Soil moisture variation in different dates and soil depths.

Date/Treatment	Soil moisture %					
	0–20 cm depth		20-40 cm depth		40-60 cm depth	
	Control	Stressed	Control	Stressed	Control	Stressed
15/6/2012	19.45±1.91	8.10±0.00	22.09±1.03	8.16±0.01	24.64±0.05	8.90±0.31
1/7/2012	18.81±0.44	7.65±0.15	20.40±0.09	7.67±0.16	22.0±0.11	9.11± 0.10
15/7/2012	19.46±0.80	6.69±0.02	21.56±0.09	8.02±0.47	23.30±0.64	8.39±0.05
30/7/2012	21.31±1.43	5.56±0.08	22.54±0.76	9.13±0.01	23.68±0.64	9.28±1.16
15/8/2012	19.46±2.89	7.64±0.17	23.26±0.23	8.67±0.01	28.15±0.00	8.98±0.61
30/8/2012	25.53±0.74	7.24±0.34	26.26±0.63	9.57±1.12	26.29±0.99	13.43±0.00
15/9/2012	21.03±0.03	9.07±0.29	26.29±0.01	9.23±0.02	27.42±0.37	9.29±0.04
4/10/2012	25.50±0.23	11.07±0.14	27.57±0.21	11.91±0.55	28.42±1.21	12.60±0.78

Survival rate

The first summer drought was proved crucial for bare-rooted seedling survival in this Mediterranean area where the extreme high temperature and very low rainfall play a significant role (Gindaba et al. 2005). Similar results were reported for bareroot seedlings of *Cercis siliquastrum* (Rahman et al. 2013). Eight months after outplanting, the survival rate of the stressed seedling sharply decreased to 45% (Figure 5); however, the survival rate of watered seedlings was also decreased to 75%. The survival rate of all seedlings after 10 and 17 months was same as it was after 8 months growth. During the June and July 2012, the total rainfall was only 4 mm and the highest temperature in July was 39.9 °C. On the other hand, the average minimum air temperatures in December 2011, January and February 2012 were 1.8°C, -2.4°C and 0.4°C respectively. Internal water stress of plants occurs either from excessive transpiration or slow water absorption from soil or a combination of both, that adversely affects their survival and growth. Newly planted seedlings can not cope with extreme cold weather as well. A part of the initial mortality of the studied bareroot seedlings may be also attributed to the disturbance and desiccation of their root system during lifting, transportation and planting. Once roots have dried, rewetting has been shown to be ineffective in preventing growth reductions, even when shoot water potential recovers (Hasse 2007). Another possible explanation for the slow root growth and mortality of *F. ornus*, during the summer months, could be the age (3 years old) of the bareroot seedlings. Younger seedlings are established faster than older ones due to less root damages (Packer and Clay 2003, Navarro et al. 2006). Nevertheless, the watered seedlings presented significantly greater field survival than drought stressed

ones during the whole studied period (17 months after outplanting). So, a positive relationship between root biomass, seedling quality index and number and length of FOLRs with the plant's field survival is evident. The watered plants which had significantly greater values of these parameters presented better field survival in contrast to water stressed ones. Similar positive relationship was found by Thompson and Schultz (1995), Davis and Jacobs (2005), Tsakaldimi et al. (2005), Tsakaldimi et al. (2013), Bayala et al. (2009), Manas et al. (2009), Rahman et al. (2013).

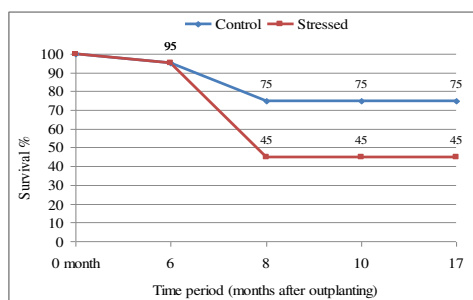

Figure 5. Course of mean survival rate of *F. ornus* seedlings in two water regimes in the field.

CONCLUSIONS

The shoot dieback which was observed in both watered and stressed bareroot seedlings of *F. ornus* decreased their height. The reduction of the initial height and the leaf dieback followed by new coppice shoot, leaf and branch growth in the lower part of stems, seems to be an adaptive mechanism of seedlings to minimize excessive transpiration and to establish in the field. Although the water stress treatment did not affect the shoot morphology of the seedlings, however, it negatively affected the root parameters and the seedling quality index. The first summer months after transplanting reduced the survival of *F. ornus* seedlings of both treatments. However, the withdrawal of irrigation in the plants during the dry summer hot months was crucial in water-stressed plants resulting in very high mortality rate. The higher survival rate of watered seedlings during the dry summer months was positively related to the moisture availability and their greater root biomass, quality index and number and length of FOLR in relation to stressed plants. Therefore, to reduce the mortality rate and for a successful establishment of bare-rooted undercut seedlings, first year irrigation is highly recommended during summer months.

REFERENCES

- Bayala J., Dianda Z.M., Wilson Z.J., Oue'draogo S.J., Sanon Z.K. (2009). Predicting field performance of five irrigated tree species using seedling quality assessment in Burkina Faso, West Africa. *New Forests* 38:309–322.
- Davis A.S., Jacobs D.F. (2005). Quantifying root system quality of nursery seedlings and relationship to outplanting performance. *New Forests* 30:295–311.

PROCEEDINGS
International Conference **REFORESTATION CHALLENGES**
03-06 June 2015, Belgrade, Serbia

- Dey D.C., Parker W.C. (1997). Morphological indicators of stock quality and field performance of red oak (*Quercus rubra* L.) seedlings underplanted in a central Ontario shelterwood. *New Forests* 14: 145-156.
- Dickson A., Leaf A.L., Hosner J.F. (1960). Quality appraisal of white spruce and white pine seedling stock in nurseries. *The Forestry Chronicle* 36: 10-13.
- Ffolliott P.F., Gottfried G.J., Cohen Y., Schiller G. (2003). Transpiration by dryland oaks: studies in the south-western United States and Northern Israel. *Journal of Arid Environments* 55: 595-605.
- Ganatsas P., Tsitsoni T., Tsakalimi M., Zagas T. (2012). Reforestation of degraded Kermes oak shrublands with planted pines: effects on vegetation cover, species diversity and community structure. *New Forests* 43: 1-11.
- Gazal R.M., Blanche C.A., Carandang W.M. (2004). Root growth potential and seedling morphological attributes of narra (*Pterocarpus indicus* Willd.) transplants. *Forest Ecology and Management* 195: 259-266.
- Gindaba J., Rozanov A., Negash L. (2004). Response of seedlings of two *Eucalyptus* and three deciduous tree species from Ethiopia to severe water stress. *Forest Ecology and Management* 201: 119-129.
- Gindaba J., Rozanov A., Negash L. (2005). Photosynthetic gas exchange, growth and biomass allocation of two *Eucalyptus* and three indigenous tree species of Ethiopia under moisture deficit. *Forest Ecology and Management* 205: 127-138.
- Grossnickle S.C. (2005). Importance of root growth in overcoming planting stress. *New Forests* 30: 273-294.
- Haase D.L. (2007). Morphological and physiological evaluations of seedling quality. Riley, LE, RK Dumroese, TD, Landis (Coords.). 2007. National Proceedings: Forest and Conservation Nursery Associations, 3-8.
- Hermann R.K. (1964). Importance of top-root ratios for survival of Douglas-fir seedlings. *Tree Planters' Notes* 64:7- 11.
- Holmgren M., Scheffer M. (2001). El Niño as a window of opportunity for the restoration of degraded arid ecosystems. *Ecosystems* 4: 151-159.
- Iannucci A., Rascio A., Russo M., Di Fonzo N., Martiniello P. (2000). Physiological responses to water stress following a conditioning period in berseem clover. *Plant and Soil* 223: 219-229.
- Jacobs D.F., Seifert J.R. (2004). Re-evaluating the significance of the first-order lateral root grading criterion for hardwood seedlings. In: Proceedings of the Fourteenth Central Hardwood Forest Conference. Wooster, OH (pp. 17-19).
- Jacobs D.F., Salifu K.F., Seifert J.R. (2005). Relative contribution of initial root and shoot morphology in predicting field performance of hardwood seedlings. *New Forests* 30: 235-251.
- Kormanik P.P., Sung S.S., Kormanik T.L., Zarnoch S.J. (1995). Oak regeneration why big is better. In: Landis T.D. and Cregg B. (Tech. Coords.), National Proceedings, Forest and Conservation Nursery Associations. USDA Forest Service, Pacific NW Res.Sta., Fort Collins, CO., Gen. Tech. Rep. PNW-GTR-365, pp.117-123.
- Kramer P.P.J., Boyer J.S. (1995). *Water Relations of Plants and Soils*. Access Online via Elsevier.
- Ludlow M.M., Muchow R.C. (1990). A critical evaluation of traits for improving crop yields in water-limited environments. *Advances in Agronomy* 43: 107-153.
- Manas P., Castro Z.E., De las Heras Z.J. (2009). Quality of maritime pine (*Pinus pinaster* Ait.) seedlings using waste materials as nursery growing media. *New Forests* 37: 295-311.
- Martínez-Sánchez J.J., Ferrandis P., Trabaud L., Galindo R., Franco J.A., Herranz J.M. (2003). Comparative root system structure of post-fire *Pinus halepensis* Mill. and *Cistus monspeliensis* L saplings. *Plant Ecology* 168: 309-320.
- Mattsson A. (1997). Predicting field performance using seedling quality assessment. *New Forests* 13: 227-252.

- Medrano H., Aguilo F., Socias F.X. (1992). Effect of drought on subterranean clover, 1: Leaf water relations of plants subjected to rapid or slowly-induced drought. *Photosynthetica* 27: 413-419
- Navarro R.M., Retamosa M.J., Lopez J., del Campo A., Cecceros C., Salmoral L. (2006). Nursery practices and field performance for the endangered Mediterranean species *Abies pinsapo* Boiss. *Ecological Engineering* 27: 93-99.
- Packer A., Clay K. (2003). Soil pathogens and *Prunus serotina* seedling and sapling growth near conspecific trees. *Ecology* 84:108-119.
- Padilla F.M., Pugnaire F.I. (2007). Rooting depth and soil moisture control Mediterranean woody seedling survival during drought. *Functional Ecology* 21: 489-495.
- Rahman M.S., Tsitsoni T., Tsakalidimi M. (2013). A comparison of root architecture and shoot morphology of *Cercis siliquastrum* L. between two water regimes. In Proceedings of 16th Forestry Congress, Thessaloniki 6-9/10/2013.
- Puttonen P. (1996). Looking for the “silver bullet”--can one test do it all?. *New Forests* 13: 9-27.
- Roller K.J. (1977). Suggested minimum standards for containerized seedlings in Nova Scotia. Canadian Forestry Service. Information Report M-X-69. 18 p.
- Rose R., Carlson W.C., Morgan P. (1990). The target seedling concept In: Rose, R.; Cambell, S.J.; Landis, T.D., eds. Proceedings of the combined meeting of the Western Forest Nursery Associations; 1990 August 13-17; Roseburg, OR. Gen. Tech. Rep. RM-200. Fort Collins, CO: USDA, Forest Service, Rocky Mountain Forest and Range Experiment Station: 1-8.
- Royo A., Gil L., Pardos J.A. (2001). Effect of water stress conditioning on morphology, physiology and field performance of *Pinus halepensis* Mill. seedlings. *New Forests* 21: 127-140.
- Schultz R.C., Thompson J.R. (1997). Effect of density control and undercutting on root morphology of 1+ 0 bareroot hardwood seedlings: five-year field performance of root-graded stock in the central USA. *New Forests* 13: 301-314.
- Teclaw R.M., Isebrands J.G. (1993). An artificial regeneration systems for establishing northern red oak on dry-mesic sites in the Lake States, USA. *Annals of Forest Science* 50: 543-552.
- Thompson J.R., Schultz R.C. (1995). Root system morphology of *Quercus rubra* L. planting stock and 3-year field performance in Iowa. *New Forests* 9: 225-236.
- Tsakalidimi M., Ganatsas P., Jacobs D.F. (2013). Prediction of planted seedling survival of five Mediterranean species based on initial seedling morphology. *New Forests* 44: 327-339.
- Tsakalidimi M., Tsitsoni T., Ganatsas P., Zagas T. (2009). A comparison of root architecture and shoot morphology between naturally regenerated and container-grown seedlings of *Quercus ilex*. *Plant and Soil* 324: 103-113.
- Tsakalidimi M., Zagas T., Tsitsoni T., Ganatsas P. (2005). Root morphology, stem growth and field performance of seedlings of two Mediterranean evergreen oak species raised in different container types. *Plant and Soil* 278: 85-93.
- Valdecantos A., Cortina J., Vallejo R. (2006). Nutrient status and field performance of tree seedlings planted in Mediterranean degraded areas. *Ann For Sci* 63: 249–256.
- Wilson E.R., Vitols K.C., Park A. (2007). Root characteristics and growth potential of container and bare-root seedlings of red oak (*Quercus rubra* L.) in Ontario, Canada. *New Forests* 34: 163-176.
- Yücedag C., Şen A.U. (2008). Manna Ash (*Fraxinus ornus* L.) in Turkey. In I International Symposium on Woody Ornamentals of the Temperate Zone 885 (pp. 425-428).
- Zaady E., Perevolotsky A. (1995). Enhancement of growth and establishment of oak seedlings (*Quercus ithaburensis*) by inoculation with *Azospirillum brasilense*. *Forest Ecology and Management* 72: 81-83.
- Zida D., Tigabu M., Sawadogo L., Odén P.C. (2008). Initial seedling morphological characteristics and field performance of two sudanian savanna species in relation to nursery production period and watering regimes. *Forest Ecology and Management* 255: 2151-2162.

IMPACT OF SOIL TO DIMENSIONS OF MECHANICAL FIBRES OF A JUVENILE WOOD OF *PAULOWNIA ELONGATA* S.Y.HU

Popović Jasmina*, Suzana Mitrović, Milorad Veselinović, Dragica Vilotić

*Corresponding author: jasmina.popovic@sfb.bg.ac.rs

Popović J., Suzana M., Milorad V., Dragica V. (2015). Impact of soil to dimensions of mechanical fibres of a juvenile wood of *Paulownia elongata* S.Y.HU. In: Ivetić V., Stanković D. (eds.) Proceedings: International conference Reforestation Challenges. 03-06 June 2015, Belgrade, Serbia. Reforesta. pp. 175-184.

Abstract: Due to excessively fast growth and possibility of simple generative and vegetative propagation, *Paulownia elongata* S. Y. Hu is a desirable species for plantation production of biomass in the world. *Paulownia elongata* S. Y. Hu originates from China, and was introduced to Serbia in 1993. So far, there have been plantations of *Paulownia* established in different habitats in Serbia. Although *Paulownia elongata* S. Y. Hu does not have any specific requirements in terms of soil, it can be assumed that quality of soil has certain impact to the growth and development of this species. One of the indicators for the quality of wood as raw material in the process of chemical-mechanical processing of wood is dimension of mechanical fibres. For that reason, the aim of this paper was to research the impact of soil to dimensions of mechanical fibres, i.e. to the length and width thereof. The samples used for researching of *Paulownia elongata* S. Y. Hu, which are obtained by vegetative propagation, were two years old. They were taken from experimental fields from three sites: Subotica Sands, Obrenovac – Veliko Polje and Ub – Pambukovica. All three sites are characterised by different physical and chemical properties of soil. The results derived from measurements of dimensions of mechanical fibres indicate that quality of soil had significant impact to the length of mechanical fibres. The impact of soil quality to the width of these anatomic elements was expressed to lesser extent. Results obtained in the research are of great importance for choosing suitable land for paulownia plantations establishing.

Key words: *Paulownia elongata* S. Y. Hu, soil quality, dimensions of mechanical fibres.

INTRODUCTION

Due to ever growing consumption of wood, there is an increased interest in fast-growing short rotation plantations focused on production of raw material for wood processing industry, especially on grounds which do not meet quality requirements for agricultural land (Vilotić et al. 2005, Milenković et al. 2008). Pulp and paper industry is continuously increasing demand for quality raw material, thus imposing a need for new, so far not utilised resources of pulp fibres (Ates et al. 2008). Plantations of *Paulownia* genus, originating from China, have been established over the past several decades in

areas with favourable climate, such as Asia, USA, Australia and Southern Europe (Portugal, Spain) (Bianco et al. 2014). This genus is characterised by extremely fast growth (Kaymakci et al. 2013).

Paulownia wood is utilised in a range of industrial field. It is used for the production of furniture, doors and windows, musical instruments, toys, plywood (Ayan et al. 2003, Clapa et al. 2014), it is suitable for the production of veneer (Barton et al. 2007) and oriented strand boards (Bergmann, 1998). Also *Paulownia* wood is raw material in manufacture of high performance wood composite panel, applied in civil engineering (Rafighi and Tabarsa, 2011, Khanjanzadeh et al. 2012), and in manufacture of pulp and paper (Latibari et al. 2012, Virginia et al. 2008, Rai et al. 2000, Lyons, 1993). Paper obtained from this wood is of high quality and can be compared to the one produced from eucalyptus (Feria et al. 2013). In addition, *Paulownia elongata* leaves with contents of proteins of 8.8 % (Koleva et al. 2011 a), glutamic acid (16.04 %), asparagine acid (11.30 %), and essential amino acids and micro- (iron, manganese) and macro-elements (calcium) (Koleva et al. 2011 b) is a source of biologically active substances.

Paulownia elongata S. Y. Hu was introduced in Serbia in 1993 through a tissue culture. Similarly to other species from *Paulownia* genus, and due to its excessively fast growth and possibility of simple generative and vegetative propagation, it is attractive for plantation production of biomass. With average annual diameter increment in breast height of 3 – 4 cm, average annual increase of *Paulownia elongata* tree volume amounts to 0.05 - 0.06 m³/ha (Akyildiz and Kol, 2010; Ayirmis and Kaymakci, 2013). Species of *Paulownia* Sieb. et Zucc. genus are adaptable to different edaphic and climate conditions (Kaymakci et al. 2013, García-Morote et al. 2014, Rahman et al. 2013). They grow on different types of soil, both sand and clay ones, even on depleted soils (Rahman et al. 2013), but most favourable soils for them are deep and well drained soils (Barton et al. 2007, Cvjetičanin and Perović 2009).

However, although *Paulownia elongata* S. Y. Hu does not have any specific requirements in terms of soil quality, researches have demonstrated that, in addition to genetic factors, habitat conditions and related properties there of play have significant impact on macroscopic characteristics, microscopic structure, density, physical, mechanical and technological properties of the wood (Vilotić and Knežević 1994, Vilotić et al. 2005, Šoškić and Popović 2002). Braga et al. (1995) concluded that texture composition of soil have great influence on its productive potential, while García-Morote et al. (2014) results showed that production of *Paulownia* biomass in dry areas and areas with clay soils is increased with irrigation or fertilisation practices.

Factors that affect the growth of these plants have similar influence of the growth and quality of plant fibres (Khalil et al. 2015). Properties of soil, such as physical ones (Pardo et al. 2000, Gil et al. 2012, Vetterlein et al. 2007), pH value, presence of nutrients, i.e. soil fertility (Clement et al. 2012, Burns et al. 2013), are listed as most significant factors that affect growth of the plants and determine fibre quality (McGrath et al. 2014, Khalil et al. 2015). It has been proved that anatomic structure of tree is closely related to physical and chemical structure of the soil (Rao et al. 1996, Aguilar-Rodriguez et al. 2006). Rahman et al. (2005) concluded that share of and rays dimensions of teak wood differed at two locations with soils of different fertility in Bangladesh. Actually, anatomic

elements of a tree are generated from vascular cambium cells (Larson 1994). Physical and chemical properties of soil influence cambium cell division and differentiation (Dünisch and Bauch 1994, Aguilar-Rodriguez et al. 2006), therefore they influence quality of cells generated in the tree.

Due to all the above stated, it was expected that quality of soil influenced the growth and development of *Paulownia elongata* grown in three experimental sites in Serbia with different soil properties. One of the important indicators of wood quality as raw material in processes of chemical-mechanical wood processing includes dimensions of mechanical fibres. For that reason, influence of soil quality to dimensions of *Paulownia elongata* mechanical fibres was researched in this paper, as they are potential source of lignocelluloses fibres for paper and composite materials.

MATERIAL AND METHODS

The research material for this paper is plants of *Paulownia elongata* S. Y. Hu, vegetatively propagated and grown in three different sites: Subotica, Obrenovac – Veliko Polje and Ub – Pambukovica.

Data used for characterisation of climate was taken from the Republic Hydro-Meteorological Service of Serbia from closest measurement points relevant for the observed sites, and these were: Valjevo for Pambukovica, Belgrade for Obrenovac and Palić for Subotica, covering the period between 1948 and 2009.

Soil analysis was conducted through standard methods, using samples from tested sites at three layer depths: 0 – 20, 20 – 40 and 40 - 60 cm. Texture of the soil was determined through sedimentation method, and chemical properties – active and substance acidity through electrometric method, the sum of adsorption alkali cations through Kappen method, hydrolytic acidity through Kappen method, total humus according to Tjurin, total nitrogen (N) according to Kjeldahl method, readily available phosphorus (P) and potassium (K) with AL method, and C/N ration through calculation.

Wood samples from three different 2-year-old plants of *Paulownia elongata* S. Y. Hu were taken from each of the sites. Nine samples from each of plants were taken at the root collar in the form of 1 cm thick rolls. The rolls were cut into match-like pieces, and then were macerated in order to obtain separate cells of the wood tissue suitable for measuring the dimensions of mechanical fibres.

Maceration of wood tissue from *Paulownia elongata* samples was carried out with the use of Franklin's reagent (Franklin 1945) (mixture of 30 % hydrogen-peroxide and glacial acetic acid in the proportion of 1:1).

The macerated mass was transferred from the test tube to laboratory glass by the means of glass tube, one drop of glycerine was put onto the material, and the whole sample was covered with glass, fixing the preparation to the base.

Measurement of *Paulownia elongata* mechanical fibres length and width was conducted on light microscope with 40x magnification power, using the "Image tool" program. Length and width of 30 fibres from the 9 samples of three plants of each plot was measured. Mean values were calculated for each of the sample groups.

The results of measurements of length and width of sampled plant fibres were processed through single-factor ANOVA, at the confidence level of 95 %.

RESULTS AND DISCUSSION

All three observed sites belong to moderate-continental climate, with average annual mean temperature of 12.2° C (Obrenovac), 11.2° C (Pambukovica), and 10.6° C (Subotica). Mean annual rainfall is smallest in Subotica (539 mm), while the greatest is in Pambukovica (778.0 mm). Annual rainfall in Obrenovac amounts to 690.6 mm. Mean air temperatures during the vegetation period range between 6.2° C and 22.4° C, with rainfall exceeding 50% of total annual rainfall, which is very favourable for plant development. Tables 1 and 2 contain test results related to soil samples taken from experimental sites in Pambukovica, Obrenovac and Subotica at three in-depth layers (00-20, 20-40 and 40-60 cm).

Table 1. Texture of soil in experimental sites in Pambukovica, Obrenovac i Subotica

Site	Depth cm	Coarse sand %	Fine sand %	Powder %	Clay %	Total sand %	Total clay %	Texture class
Obrenovac (OB)	00-20	5.4	25.2	27.1	42.3	30.6	69.4	Clay
	20-40	5.7	25.0	26.8	42.5	30.7	69.3	
	40-60	5.5	24.0	26.4	44.0	29.6	70.4	
Pambukovica (PB)	00-20	2.6	30.3	28.6	38.5	32.9	67.1	Clay loam
	20-40	2.6	31.4	28.1	37.9	34.0	66.0	
	40-60	2.1	31.6	27.3	39.0	33.7	66.3	
Subotica (SU)	00-20	1.6	84.1	4.3	10.0	85.7	14.3	Loam sand
	20-40	0.9	84.4	3.9	10.8	85.3	14.7	
	40-60	1.1	84.9	4.0	10.0	86.0	14.0	

Heavy texture of soil in Obrenovac, with high content of clay (69.30 -70.40%) at all three layers (Table 1) results in low water permeability of soil and low aeration, thus classifying it into clay class.

Soil in Pambukovica, with high content of total clay (66.00 – 67.10%), and low content of total sand at all three sampled layers (Table 1) is of similar texture as soil in Obrenovac. Due to high contribution of clay, the soil has low water permeability and aeration. The soil in Pambukovica is classified into clay loam class.

Quite opposite to the previously described, soil in Subotica site is characterised with lighter texture, with high content of total sand of more than 85%, and content of total clay lower than 15% (Table 1). Such texture of soil enables faster infiltration of rainfall, high absorption capacity and very low capacity of available water retention. In terms of texture, this soil belongs to loam sands.

Similarity in physical properties of soils in Obrenovac and Pambukovica are reflected in chemical properties as well. Both types of soils are characterised by alkali reaction of soil solution, high total capacity of adsorption for alkali cations, which is a consequence of heavy texture structure, as well as great sum of adsorbed alkali cations,

which results in high degree of saturation with alkali cations of more than 50% of total adsorption capacity (Table 2). In addition, the soil in these two experimental sites is excessively well provided with readily available forms of potassium (K) (more than 20 mg/100 g) (Table 2). When it comes to contents of total humus, both soils have low content of humus with close ratio of C/N. Significant differences are observed in contents of nitrogen (N), which is excessively low in Pambukovica, while saturation of Obrenovac soil with nitrogen is very good (0.23 – 0.37%). Quantities of phosphorus (P) readily available to plants in Obrenovac soil is 24.19 – 25.62 mg/100 g, and is very high (Table 2). Unlike that, saturation of Pambukovica soil with this element is 0.0 – 0.5 mg/100 g (Table 2), which is extremely low and insufficient for most forest species.

Table 2. Chemical properties of soil in experimental sites in Pambukovica, Obrenovac i Subotica

Site	Depth in cm	pH		Adsorption complex *				Total		C/N		Available	
		H ₂ O	KCl	T	S	T-S	V	Humus	N		P ₂ O ₅	K ₂ O	
				Equiv.m.mol/100g				%	%	%	mg/100g		
Obrenovac (OB)	00-20	5.6	5.0	32.2	23.3	8.9	72.3	1.1	0.2	2.8	24.2	23.3	
	20-40	5.8	5.2	33.5	24.6	8.9	73.5	2.12	0.4	3.4	24.9	26.7	
	40-60	5.8	5.1	32.6	23.8	8.9	72.8	1.7	0.4	2.8	25.6	24.0	
Pambukovica (PB)	00-20	5.0	3.9	34.2	18.4	15.8	53.9	0.7	0.1	3.1	0.5	22.8	
	20-40	5.0	3.9	32.9	18.0	14.9	54.7	0.7	0.1	3.4	0.5	24.2	
	40-60	5.1	3.9	33.4	18.0	15.3	54.0	0.5	0.1	2.9	0.0	17.4	
Subotica (SU)	00-20	6.1	5.5	12.2	9.5	2.7	78.2	1.1	0.2	6.4	7.7	7.0	
	20-40	7.3	6.5	10.8	10.0	0.9	91.8	0.4	0.1	3.4	5.3	4.3	
	40-60	7.3	6.8	11.7	10.8	0.9	92.4	0.6	0.1	5.1	4.2	3.9	

*T – total adsorption capacity for alkali cations

S – sum of adsorption alkali cations

T-S = H unsaturation of complex with alkalis, or deficit of alkalis (hydrolytic acidity also)

V – level of soil saturation with adsorbed alkali cations (Ca Mg, K Na)

Soil in Subotica, its texture and chemical properties, significantly differs from the other two tested samples. Reaction of soil solution from the surface of this site is slightly acid (pH = 6.13); as it goes into deeper layer it becomes neutral to slightly alkaline (pH = 7.34) (Table 2). The differences are also observed in very small total adsorption capacity of soil in Subotica, as well as in small sum of adsorbed alkali cations, but due to low adsorption capacity, the degree of saturation of adsorption complex with alkali cations is high, in deeper layers it exceeds 90% (Table 2). The contents of humus and nitrogen are low. Provision of plants with readily available forms of phosphorus (4.16 – 7.66 mg/100 g) and potassium (3.92 – 7.02 mg/100 g) is low in the whole soil depth, but is sufficient for forest trees needs.

Mean values related to length of mechanical fibres of *Paulownia elongata* grown in experimental sites in Obrenovac, Pambukovica and Subotica can be seen in Figure 1, and they range from 0.372 mm (PB) to 0.552 mm (SU). The measured values of mechanical fibres length are considerably smaller compared to fibre length of 0.82 mm measured on 2-year-old *P. elongata* grown in plantations in the west of Turkey (Ates et al. 2008), which is probably a consequence of different growth conditions. Also, length of fibres in tested samples are of smaller values compared to values of 1.078 – 1.116 mm

measured in fast-growing hardwood (*Populus x euramericana* cv. *Robusta* and cl. I-214, *Populus deltoides* cl. 618 and cl. 450), whose age ranges between 9 and 16 years, grown in plantations in Serbia as raw material for the production of fibres (Klašnja et al. 2006).

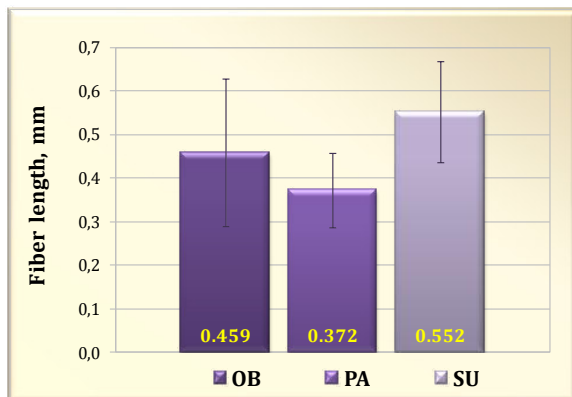

Figure 1. Length of *Paulownia elongata* S. Y. Hu mechanical fibres (mm) from experimental fields in Obrenovac (OB), Pambukovica (PA) and Subotica (SU)

Differences in values of fibre lengths in tested trees of *Paulownia elongata* grown in three different sites in Serbia are statistically significant (Table 3). Taking into account that vegetative propagation excludes the influence of genetic factors, as well as that climate conditions are very similar in all three sites, the observed differences in the length of *Paulownia elongata* fibres can be attributed to soil quality.

Table 3. Results of statistical analysis of results obtained in measurement of fibre lengths (ANOVA)

	<i>F</i>	<i>P-value</i>	<i>F crit</i>
OB/PA	19.14094*	2.06E-05	3.894232
OB/SU	13.56967*	0.000322	3.90506
PA/SU	120.7256*	6.56E-21	3.90506

*denotes a statistically significant difference at the confidence level of 95 %

With its value of 0.372 mm, the length of *P. elongata* fibres in Pambukovica site is the smallest (Figure 1). Compared to other two sites, this soil has the most expressed lack of organic matter and highest acidity, which probably influenced that *P. elongata* fibres from this experimental site were the shortest. The content of nitrogen (0.11 - 0.13%), and phosphorus (up to 0.5 mg /100 g), which are important for plant metabolic processes and influence the quality of fibres (Larson 1994), is also low. According to Drewnik (2006), the lack of nitrogen results in low productivity and poor quality of fibres.

According to its texture, the soil in experimental field of Obrenovac is similar to the soil in Pambukovica, while differences are greater in terms of chemical properties. Lower acidity, somewhat higher content of humus and nitrogen, and excessively higher content of available phosphorus in this soil, compared to soil in Pambukovica, influenced the length of fibres from samples grown in experimental site of Obrenovac, which is 0.459

mm, and is greater. Hossain et al. (2011) concluded that length and yield of fibres vary depending on carbon level in soil. Lack of other nutrients can also influence reduction of fibre length (Sawan et al. 2006).

Although the contents of available phosphorous and potassium in soil in Subotica was more than three times smaller compared to the soil in Obrenovac, the length of fibres of 0.552 mm in samples of *Paulownia elongata* from this experimental site is the greatest. As already said, properties of soil in this experimental site considerably differ from other two samples in terms of texture and chemical properties. Light texture, high degree of soil saturation with adsorbed alkali cations, low acidity of soil, as well as two to three greater C/N ratio compared to other two samples of soil can influence greater length of fibres of *P. elongata* grown in this experimental site.

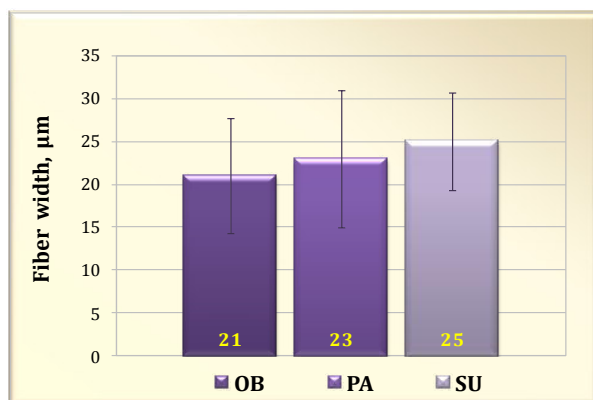

Figure 2. Width of mechanical fibres of *Paulownia elongata* S. Y. Hu (µm) from experimental sites in (OB), Pambukovica (PA) and Subotica (SU)

The results of measurements of fibres width in tested samples of *P. elongata* grown in three experimental sites confirm that the soil in Subotica has most favourable properties for growing of this plant species (Figure 2). Beside the length of sample fibres taken from this site, which were of greatest value, also the width of fibres of 25 µm was the greatest (Figure 2). The width of mechanical fibres of *P. elongata* from the site of Pambukovica of 23 µm is not considerably statistically smaller (Table 4).

Table 4. Results of statistical analysis of measurement results related to fibre width (ANOVA)

	<i>F</i>	<i>P-value</i>	<i>F crit</i>
OB/PA	4.537981*	0.034524	3.894232
OB/SU	12.13416*	0.000651	3.90506
PA/SU	1.264057	0.262705	3.90506

*denotes a statistically significant difference at the confidence level of 95 %

However, the width of mechanical fibres in tested samples grown in the area of Obrenovac of 21 µm is significantly smaller compared to samples taken from other two sites (Table 4). The reason for that can be high content of phosphorus of more than 24 %

(Table 2) in the soil where these samples were grown. Namely, Larson (1994) stated that phosphorous influenced the activity of cambium. The increased activity of cambium is followed by changes in anatomic structure, which are mainly reflected in greater pores, thinner fibre cell walls, and greater share of parenchymatous cells (Larson 1994).

CONCLUSIONS

The results of measurements of mechanical fibres dimensions in *P. elongata* grown in three experimental sites have confirmed that soil quality influenced their dimensions.

It has been established that the greatest length (0.552 mm) and width (25 μm) were found at *P. elongata* fibres grown at experimental plot in Subotica, where soil considerably differed in physical and chemical properties compared to samples taken from other two sites. Light texture, low acidity of soil, as well as two to three times higher proportion of C/N compared to the remaining two soil samples probably influenced that *Paulownia elongata* fibres from this experimental site were longer and wider than the others.

On the other hand, it may be assumed that low pH value combined with low content of humus, nitrogen and phosphorus of Pambukovica soil influenced that fibres of *P. elongata* samples from this experimental site were shorter (0.372 mm).

Excessively high content of phosphorus in Obrenovac soil probably influenced that fibres from this experimental site were of the smallest width (21 μm).

Based on this paper results, it can be concluded that, from the aspect of fibres dimensions, conditions in Subotica are most favourable for plantation of *Paulownia elongata*.

REFERENCES

- Aguilar-Rodriguez S., Terrazas T., Lopez-Mata L. (2006). Anatomical wood variation of *Beddeja cordata* (Buddlejaceae) along its natural range in Mexico, *Trees*, 20, 253-26.
- Akyildiz M.H., Kol S.H. (2010). Some technological properties and uses of *Paulownia* (*Paulownia tomentosa* Steud.) Wood, *Journal of Environmental Biology*, 31, 351-355.
- Ates S., Yonghao N., Akgul M., Tozluoglu A. (2008). Characterization and evaluation of *Paulownia elongata* as a raw material for paper production, *African J. Biotechnol.*, 7(22): 4153-4158.
- Ayan S., Sadlam I., Sivaciödlü A. (2003). *Paulownia* Sieb. & Zucc.: A new exotic genus for multi-purpose uses in Kastamonu-Turkey. Decision support for multiple purpose forestry, April 23-25, 2003. Vienna, Austria.
- Ayrimis N., Kaymakci A., (2013). Fast growing biomass as reinforcing filler in thermoplastic composites: *Paulownia elongata* wood, *Industrial Crops and Products*, 43: 457- 464.
- Barton I., Nicholas I., Ecroyd C. (2007). *Paulownia*, *Forest Research Bulletin* 231, New Zealand Forest Research Institute: Rotorua, New Zealand, p. 71.
- Bergmann B.A. (1998). Propagation method influences first year field survival and growth of *Paulownia*, *New Forests*, Vol. 16, (3): 251-264.

- Bianco P., Ciccarese L., Jacomini C., Pellegrino P. (2014). Impacts of short rotation forestry plantations on environments and landscape in Mediterranean basin. *Rapporti* 196/14. ISPRA – Istituto Superiore per la Protezione e la Ricerca Ambientale, Roma, 115 p.
- Braga F.A., Vale F.R., Muniz J.A. (1995). Movimentação de nutrientes no solo, crescimento e nutrição mineral do eucalipto, em função de doses de gesso e níveis de irrigação. *Revista Brasileira de Ciências do Solo*, v.19, 69-77.
- Burns R.G., DeForest J.L., Marxsen J., Sinsabaugh R.L., Stromberger M.E., Wallenstein M.D. (2013). Soil enzymes in a changing environment: current knowledge and future directions, *Soil Biol. Biochem.*, 58:216–234.
- Clapa D., Fira A., Simu M., Vasu L.B., Buduroi D. (2014). Improved In Vitro Propagation of *Paulownia elongata*, *P. fortunei* and its Interspecific Hybrid *P. elongata* x *P. fortunei*, *Bulletin UASVM Horticulture*, 71(1): 6-14.
- Clement J.D., Constable G.A., Stiller W.N., Liu S. M. (2012). Negative associations still exist between yield and fibre quality in cotton breeding programs in Australia and USA, *Field Crops Res.*, 128: 1–7.
- Cvjetičanin R., Perović M. (2009). Pregled vrsta roda paulovnja (*Paulownia* Sieb. et Zucc.) i njihove bioekološke karakteristike, *Šumarstvo*, 3-4: 111-121.
- Drewnik M. (2006). The effect of environmental conditions on the decomposition rate of cellulose in mountain soils. *Geoderma*, 132: 116–130.
- Dünisch O., Bauch J. (1994). Influence of mineral elements on wood formation of old growth spruce (*Picea abies* [L.] Karst.). *Holzforshung* 48: 5–14.
- Feria M.J., García J.C., Zamudio M.A.M., Gomide J.L., Colodette J.L., López F. (2013). Kraft Pulping and Bleaching of *Paulownia* Sun Tzu 104® Wood, *Cellulose Chemistry and Technology*. 47(7-8): 595-601.
- Franklin G.L. (1945). Preparation of thin sections of synthetic resins and wood resin composites, and a new macerating method for wood, *Nature* 51: 145.
- García-Morote F.A., López-Serrano F.R., Martínez-García E., Andrés-Abellán M., Dadi T., Candel D., Rubio E., Lucas-Borja M.E. (2014). Stem Biomass Production of *Paulownia elongata* x *P. fortunei* under Low Irrigation in a Semi-Arid Environment, *Forests*, 5, 2505-2520.
- Gil P.M., Bonomelli C., Schaffer B., Ferreyra R., Gentina C. (2012). Effect of soil water-to-air ration biomass and mineral nutrition of avocado trees. *J. Soil Sci. Plant. Nutr.*, 12:609-630.
- Hossain M.D., Hanafi M.M., Jol H., Hazandy A.H. (2011). Growth, yield and fiber morphology of kenaf (*Hibiscus cannabinus* L.) grown on sandy bris soil as influenced by different levels of carbon, *Afr. J. Biotechnol.*, Vol. 10 (50): 10087–10094.
- Kaymakci A., Bektas I., Bal B.C. (2013). Some Mechanical Properties of *Paulownia* (*Paulownia elongata*) Wood, *International Caucasian Forestry Symposium*, 24-26 October, 2013, Artvin, Turkey, 917-919.
- Khalil H.P.S.A., Hossain S., Rosamah E., Azli N.A., Saddon N., Davoudpoura Y., Islam N., Dungani R. (2015). The role of soil properties and its interaction towards quality plant fiber: A review: *Renewable and Sustainable Energy Reviews*, 43: 1006–1015.
- Khanjanzadeh H., Bahmani A.A., Rafighi A., Tabarsa T. (2012). Utilization of bio-waste cotton (*Gossypium hirsutum* L.) stalks and underutilized paulownia (*paulownia fortunei*) in wood-based composite particleboard, *African Journal of Biotechnology*, 11(31):8045-8050.
- Klašnja B., Kopitović Š. (2006). Drvo topola kao sirovina za proizvodnju vlakana, Poljoprivredni fakultet Novi Sad, Institut za nizijsko šumarstvo i životnu sredinu, Novi Sad.
- Koleva A., Dobreva K., Stoyanova M., Denev P., Damianova S., Ilchev A., Tasheva S., Ganchev G., Pavlov D., Angelov B., Stoyanova A. (2011 a). *Paulownia* – A Source of Biologically Active

- Substances 1. Composition of Leaves, Journal of Mountain Agriculture on the Balkans, vol. 14, 5: 1061-1068.
- Koleva A., Dobрева K., Stoyanova M., Denev P., Damianova S., Ilchev A., Tasheva S., Ganchev G., Pavlov D., Angelov B., Stoyanova A. (2011 b). Paulownia – A Source of Biologically Active Substances 2. Amino Acid Composition of Leaves, Journal of Mountain Agriculture on the Balkans, vol. 14 (5): 1078-1086.
- Larson P.R. (1994). The vascular cambium: development and structure. Springer Verlag, Berlin.
- Latibari A.J., Pourali K., Roghani A.F. (2012). Alkaline Peroxide Mechanical Pulping of Fast-Growth Paulownia Wood, Bio Resources, 7(1): 265-274.
- Lyons A. (1993). Paulownia In: Agroforestry - Trees for Productive Farming, Ed. D. Race., Agmedia, East Melbourne.
- McGrath J.M., Spargo J., Penn C.J. (2014). Soil fertility and plant nutrition encyclopedia of agriculture and food systems: p.166–184.
- Milenković M., Vilotić D., Radošević G. (2008). Mogućnosti primene vrsta *Paulownia elongata* i *P. fortunei* u biološkim protivpožarnim pojasevima. I međunarodna naučna konferencija Bezbednosni inženjering i XI međunarodna konferencija Zaštita od požara i eksplozije. Novi Sad, 268-273.
- Pardo A., Amato M., Chiarandà F.Q. (2000). Relationships between soil structure, root distribution and water uptake of chickpea (*Cicer arietinum* L.), Plant growth and water distribution, Eur. J. Agron., 13:39–45.
- Rafighi, A., Tabarsa, T. (2011). Manufacturing high performance wood composite panel from paulownia, J. Key Eng. Mater 471–472, 1091–1094.
- Rahman A., Rahman F., Rahmatullah M. (2013). *In vitro* regeneration of *Paulownia tomentosa* Steud. plants through the induction of adventitious shoots in explants derived from selected mature trees, by studying the effect of different plant growth regulators, American-Eurasian Journal of Sustainable Agriculture, 7(4): 259-268.
- Rahman M.M., Fujiwara S., Kanagawa Y. (2005). Variations in volume and dimensions of rays and their effect on wood properties of teak. *Wood and Fiber Science* 37: 497–504.
- Rai A.K., Singh S.P., Luxmi C., Savita G. (2000). *Paulownia fortunei* – a new fiber source for pulp and paper. Indian Pulp Paper Tech. Assoc. 12(4): 51-56.
- Rao C.D., Goh C.J., Kumar P.P. (1996). High frequency adventitious shoot regeneration from excised leaves of Paulownia Spp. cultivated in vitro, Plant Cell Reports, 16: 204-209.
- Sawan Z.M., Hafez S.A., Basyony A.E., Alkassas A.R. (2006). Cottonseed, protein, oil yields and oil properties as affectedness by nitrogen fertilization and foliar application of potassium and a plant growth retardant. World J. Agric. Sci. 2: 56–65.
- Šoškić B., Popović Z. (2002). Svojstva drveta, Šumarski fakultet, Beograd.
- Vetterlein D., Szegedi K., Stange F., Jahn R. (2007). Impact of soil texture on temporal and spatial development of osmotic-potential gradients between bulk soil and rhizosphere, J. Plant Nutr. Soil. Sci., 170: 347-356.
- Vilotić D., Knežević M. (1994). Study of Virginia Live Oak (*Quercus virgiliana* /Ten./Ten.) width of vessel elements at different sites of the Deliblato sand. The Deliblato sands – Proceedings VI (2): 299-306, Belgrade UDK 811.14/15:176.1 *Quercus virgiliana*
- Vilotić D., Radošević G., Vukovojac S. (2005). Comparative studies of anatomic structures of *Paulownia elongata* and *Paulownia fortunei*, In: Forests and Sustainable Development. Proceedings of the Symposium, Braşov, 1-6.
- Virginia M.F.G., Evtuguinb D.V., Dominguesa M.R.M. (2008). Structural characterization of the acetylated heteroxytan from the natural hybrid *Paulownia elongata*/*Paulownia fortunei*, Carbohydr. Res., 343: 256-266.

**PERSPECTIVES OF AUSTRIAN PINE PLANTED FOREST IN THE FOREST
MANAGEMENT AREA “TESLIĆ” (BOSNIA AND HERZEGOVINA)**

**Jović Goran, Dukić Vojislav, Maunaga Zoran, Stajić Branko, Cvjetković Branislav*, Subotić
Jelena**

*Corresponding author: cvjetkovicb@gmail.com

Jović G., Dukić V., Maunaga Z., Stajić B., Cvjetković B., Subotić J. (2015). Perspectives of Austrian pine planted forest in the forest management area “Teslić” (Bosnia and Herzegovina). In: Ivetić V., Stanković D. (eds.) Proceedings: International conference Reforestation Challenges. 03-06 June 2015, Belgrade, Serbia. Reforesta. pp. 185-193.

Abstract: This paper presents the analysis of the condition and perspectives of Austrian pine planted forest in the forest management area “Teslić”. The forest management area “Teslić” is located in the western part of the Republic of Srpska (the area of the river basin Usora and partly of the area of the river basin Ukrina). The first Austrian pine planted forest in the area were established before the end of the nineteenth century, mostly next to settlements and road communications. The excessive cutting caused degradation of forest sites. In the forest management area “Teslić”, planted forests of Austrian and Scots pine are spread over the area of 5,549 hectares, which presents 18% of the total area under planted forests of Austrian and Scots pine in the Republic of Srpska. The data needed to analyze the situation in the Austrian pine planted forests were collected from the available documentation and temporary established sample plots. Five sample plots were set up in the stands that have not been thinned so far, and one sample plot was set in a stand that had an adequate silvicultural treatment. Significant differences between stands condition that have not been thinned so far and condition of the stand that had an adequate silvicultural treatment have been determined. Austrian pine planted forests in the studied forest management area are not adequately treated. Without a radical change in management approach, planted forests have a negative future perspective.

Key words: Austrian pine, planted forest, thinning, condition.

INTRODUCTION

On the territory of Bosnia and Herzegovina gradual afforestation of barren land started after the Second World War, with the aim to expand the raw material base, enable greater exploitation of the stand production potential and environmental protection. The afforestation was mostly carried out with Austrian pine (*Pinus nigra* Arn.) and less frequently with Scots pine (*Pinus silvestris* L.), Norway spruce (*Picea abies* L.) and some types of allochthonous conifers (*Pinus strobus*, *Pseudotsuga menziesii*, *Larix decidua*). Due to its characteristics, Austrian pine has modest demands regarding the site productivity characteristics, is considered to have a wide utility value as raw material, has the ability to

PROCEEDINGS

International Conference **REFORESTATION CHALLENGES**

03-06 June 2015, Belgrade, Serbia

grow on poor sites, grows fast and has great resistance to draught or frost, has an adaptive root, is the planting stock which is relatively easy to be produced, so accordingly, those were the determining factors for selecting Austrian pine for afforestation (Maunaga 1999).

Austrian pine planted forests have been set up on soils of all types of parent rocks, both poor and good quality. This species can grow in poor habitat conditions, especially in poor site conditions, and in poor site conditions it achieves relatively good growth and productivity results. Austrian pine does not efficiently use the potentials of good soils which suit other production species such as Norway spruce, European beech and others, so the question is whether the afforestation of these sites with Austrian pine is justifiable; the same question refers to the forests already planted on 'someone else's' good sites, so it is questionable whether they should be kept and managed. (Stamenković and Vučković 1988).

Intensive utilization of the forests from Usora-Ukrina area (called Teslić today) started by the end of the Ottoman rule in B&H. More extensive utilization of oak stands in this area started after the occupation by Austro-Hungarian Monarchy in 1878 (Begović, 1986). Uncontrolled cutting of oak trees which were used for the production of wooden staves for barrel and clear cutting of European beech stands on large surfaces with the aim to provide sufficient amounts of European beech wood for the needs of the distillery in Teslić resulted in creating barren land or degraded stands.

According to Kesterčanek (1897), the first planted forests of Austrian pine in Usora-Ukrina region were established by the end of the nineteenth century, mostly close to settlements and road communications. Intensive work on planting Austrian pine forests in currently called "Teslić" forest management area started after the Second World War.

MATERIAL AND METHODS

Teslić forest management area is located at a latitude of 44° 36' and longitude of 17°54', in the western part of the Republic of Srpska. It is located in the area of the river Usora basin and partly the Ukrina river basin. In its western part there is the mountain massif Borja, while its southern part is bordered by the slopes of the mountain massifs Vlašić and Manjača. The highest point is 1,383 meters high (Očauš), while the lowest point is located downstream the river Usora (Tedin Han), at an altitude of 166 meters.

The data needed for the analysis of the condition of Austrian pine planted forests were collected by summarizing the information from the available planning documentation (Forest Management Plans, commission reports of the accomplished silvicultural work) and by setting up sample plots in the stands which belong to the oldest represented age class (51 to 60 years). Out of the total number of six temporary sample plots which were set up, five sample plots (OP2-OP6) were set up in the stands which haven't been appropriately treated (thinned), while one sample plot was set up in the stand where tending measures were applied (OP1).

The stand (MU "Donja Velika Usora"- compartment 208), in which Sample plot 1 (OP1) was set up, is the only stand in the studied age class in „Teslić“ forest management area which was thinned several times in recent years (1970, 1986, 1998 and 2005). In this

PROCEEDINGS

International Conference REFORESTATION CHALLENGES

03-06 June 2015, Belgrade, Serbia

research the thinned stand is used as an optimal structure stand model for the observed age with which the structure of the unthinned stands is compared.

Three sample plots were set up in the stands which were established in the site of Sessile oak mountain forest (*Quercetum petraeae-daleschampii serpentinum Stef.*), the others in the stands set up on the following sites: one in a Sessile oak and winter heath mountain forest (*Erico-Quercetum petraeae Ht. 59.*), one in a fir and common hornbeam forest (*Carpino betuli-Abietetum*), and one in a European beech and common hornbeam forest (*Rusco hypoglossi-Fagetum subpannonicum, subas. Carpinetosum betuli Stef.*).

In each selected stand was set up one square-shaped sample plot with the dimensions 30 m x 30 m (900 m²). The diameter and height of all trees were measured and, according to Pintarić (1991), it was also determined whether they belonged to certain classes according to IUFRO Tree Classification. Extracted core samples were taken from 12 trees on each sample plots with the aim to estimate the vitality of the stands.

RESULTS AND DISCUSSION

According to the data from the Forest Management Plans (FMP), on the territory of "Teslić" forest management area planted forests spread on 5,838.4 ha, which is 10% of the planted forest area in the Republic of Srpska. Austrian pine and Scots pine planted forests spread on the surface of 5,549.3 ha, which is 18% of the surface under Austrian pine and Scots pine planted forests in the Republic of Srpska.

The overview of the wood stock distribution according to diameter classes in Austrian pine and Scots pine planted forests in "Teslić" forest management area is given in Table 1. 569,913 m³ (79%) of Austrian pine wood stock i.e. 102.7 m³/ha belong to diameter classes of 11-20 cm and 21-30 cm. The growing stock in Austrian pine and Scots pine planted forests on the surface of 5,549.3 ha is 715,854 m³. According to Forest Management Plans for "Teslić" forest management area, pine forests were put in six management units. Table 2 shows the overview of the growing stock and the forest areas under Austrian pine and Scots pine forests according to their age classes.

Table 1. Distribution of growing stock according to diameter classes in Austrian pine and Scots pine planted forests in "Teslić" forest management area

Diameter class(cm)	6-10	11-20	21-30	31-50	51-80	>80	Total
m ³ ha ⁻¹	11.5	65.2	37.5	13.8	1.0	0.0	129.0
%	9	50	29	11	1	0	100

In the first years after the war (World War II) the territory of Teslić municipality was characterized by extensive afforestation which was carried out with limited funds and without recruiting enough professional staff. Afforestation activities were often in the form of unplanned work and the recruitment of a large number of workers. Large surfaces were treated and due to the lack of funds unpaid workforce was recruited (so-called work drives), which later proved to be quite inadequate for such professional activities.

Afforestation activities were carried out without having previously prepared technical documentation.

Table 2. The area and volume of the growing stock in Austrian pine and Scots pine planted forests in "Teslić" forest management area

Age class						Total
1-20	21-40	41-60	61-80	81-100	101-120	
Area (ha)						
1,808.6	3,571.0	169.7	-	-	-	5,549.3
Growing stock (m³)						
58,921.0	616,081.5	40,852.0	-	-	-	715,854.5

In the period from 1947 to 1951 the afforestation of substantial surfaces of barren land was carried out mostly with Austrian pine and Scots pine seedlings, but in their records, commissions often reported minimal results. Because of these specific reasons (unprofessional approach), the results of the work on planting forests were often very bad. Pine forests were established with the planting density of 10,000 trees per ha, sometimes up to 12,000 seedlings per hectare (on degraded land).

The dynamics of the increase of the surfaces under planted forests in the territory of "Teslić" forest management area for the period from 1 January 1965 to 1 January 2005 is shown in Figure 1. According to the cadastre data, on 1 January 1965 the total surface of planted forests in this territory was 1.110 ha or 2.2% of the total forest area in "Teslić" forest management area, on 1 January 1995 it was 6,127 ha and 5,838 ha on 1 January 2005. Primarily due to the changes of the boundaries of the area, the surface covered with planted forests in "Teslić" forest management area was reduced by 289 ha, compared to the situation in 1995.

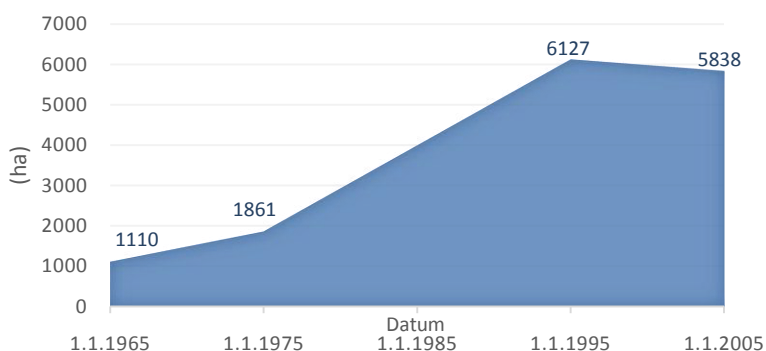

Figure 1. Overview of the surfaces covered with planted forests according to the data from the Forest Management Plans (According to the data from FMP for the periods 1975-1994, 1995-2004 and 2005-2014)

Although the Forest Management Plans require thinning after 15 years of stand age, in practice it was not the case. The lack of tending and management measures for

planted forests can be registered in control records i.e. the development of pine cultures was left to the action of natural factors.

Table 3 shows the basic stand structure elements established on sample plots (Figure 2) set up in the oldest represented age class (51-60 years). Great deviation of stand structure elements was determined on the thinned sample plot OP1 compared to the determined elements on other sample plots OP2-OP6. Unthinned stands at a particular age have a considerably higher number of trees and a smaller mean diameter than the thinned stand i.e. than the optimal structure of stands.

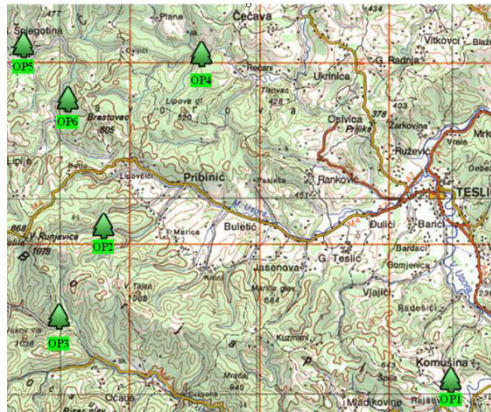

Figure 2. The sample plots (OP1-OP6) locations in the forest management area “Teslić” (Jović et al. 2012)

Table 3. Basic stand structure elements (number of trees – N, root mean square of trees dbh - DBH, basal area - G, stand height - h_L , volume – V, current annual increment – I_v)

Sample plots	N	DBH	G	h_L	V	I_v
	ha ⁻¹	cm	m ² ha ⁻¹	m	m ³ ha ⁻¹	
OP1	389	32	31.3	26.4	354	6.35
OP2-OP6	1282	21	43.7	19.8	387	4.8

In order to analyze and assess the structural characteristics of the stand from the silvicultural aspect, IUFRO classification of trees, which has a dual character – biological and management, was applied according to Pintarić (1991). The obtained percentage share of individual classes in the total number of trees in the thinned (OP1) and unthinned stands (OP2-OP6) is shown in Table 4.

In the thinned stand all the trees are in the upper storey and they are considerably more vital compared to the trees from the unthinned stands. 74.3% of trees are of extremely high vitality and 97.1% of trees have been selected for their silvicultural role. Also, the thinned stand has the best quality of tree trunks (88.6% of trees have excellent quality trunks) due to the fact that most phenotypically bad trees were removed from this surface through silvicultural operations. Austrian pine trees in this stand have considerably longer crowns (62.9% of trees are with longer crowns), compared to the trees from the unthinned stands, which directly correlates with tree vitality.

Table 4. Number of trees (%), by IUFRO classification system

Characteristics	IUFRO class	Sample plots	
		OP1	OP2-OP6
Stand layer	upper layer	100	83.2
	middle layer	0	15.9
	lower layer	0	0.9
Vitality	strong	74.3	19.8
	normal	25.7	51.7
	weak	0	28.5
Growth tendency	advanced	78.4	17.0
	accompanying	8.4	54.2
	lagging	13.2	28.8
Silvicultural role	future tree	97.1	41.5
	useful	2.9	24.7
	harmful	0.0	33.8
Stem quality	excellent quality	88.6	41.3
	medium quality	8.6	33.9
	bad quality	2.8	24.8
Crown length	long	62.9	11.2
	medium	37.1	86.4
	short	0	2.5
Tree health	healthy	97.1	86.5
	slight damaged	2.9	8.1
	heavy damaged	0.0	5.4

By applying tending measures (thinning), this stand was brought into an optimal state from biological and management aspects relating the assessed parameters. Contrary to the thinned stand, the unthinned stands are characterized by smaller vitality of trees and greater presence of trees which are harmful for the selected trees considering their silvicultural role. Trees from the unthinned stands have trunks of much worse quality.

As a measure for assessing the stability and growth potential of one stand, slenderness ratio can also be used - the smaller the vitality ratio is, the bigger is the capacity of the stand to resist the effects of snow or storms (Preuhsler 1991). The established values of slenderness ratio for all trees in the stand (h/d), for the thinned stands ($h/d = 82$) and for the unthinned stands ($h/d = 96$) are shown in Figure 3. Based on the established slenderness ratio and contrary to the thinned stand, the condition in the unthinned stands is unfavorable i.e. the stands are unstable which means that, while performing the potential thinning process on these sample stands, there is a considerable risk of the influence of snow and wind (snow break and windfall wood), so considerable caution is needed.

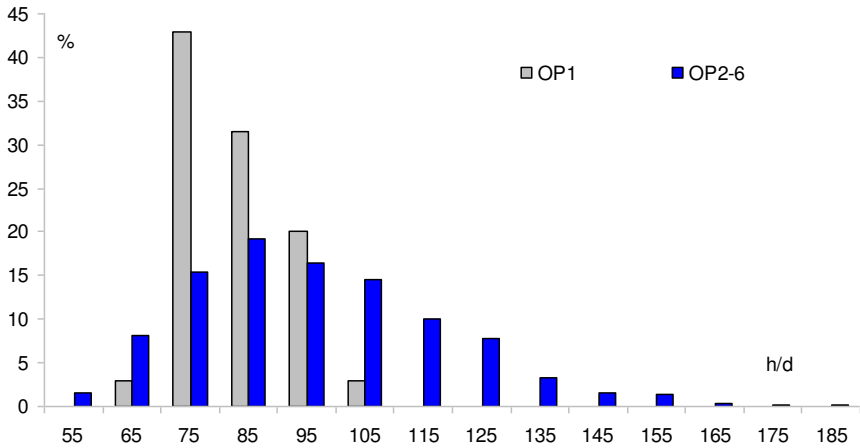

Figure 3. Number of trees (%), by slenderness ratio

Tree vitality of Austrian pine was tested on diameter increment i.e. the width of increment rings. The analysis of the diameter increment presents a significant base for assessing the vitality and a reliable prognosis of the future development of trees and stands. The trees in the stand are divided into three biological positions following the instructions from the Faculty of Forestry in Belgrade (Stamenković and Vučković 1988), and then 4 trees were drilled to the pith on each sample plot and in every biological position. To minimize the effect of age, i.e. to have a better insight into the reaction of trees to the effect of exogenous factors on diameter increment the growth ring indexes for trees from all three biological positions were calculated:

$$I = \frac{i}{\hat{i}_r}$$

(I - growth ring index, i - actual width of the ring and \hat{i}_r - estimated width of the ring)

The annual ring width estimate related to specific functions didn't give satisfying results, so the moving average method was used (for periods of 5 years). All trees which have growth ring index lower than 1 in the studied period show hidden symptoms of loss of vitality (Table 5). Trees with low growth ring index don't have enough capacity for water and nutrients transmission, which, in the case of dominant trees and due to developed crowns and great 'transport distance', often results in an imbalance between the inflow and waterconsumption, i.e. the loss of vitality and dieback (Vučković et al. 2005).

Based on the ratio of the trees with hidden symptoms of loss of vitality and vital trees, it can be concluded that the trees from the thinned sample plot are considerably more vital than the trees from those sample plots which were not thinned and consequently, that refers to the whole stand. The stands which were not thinned during their development have low vitality.

Table 5. Share of vital and devitalized trees in thinned and unthinned stands

Sample plots	structure of stands		vital trees		with hidden symptoms of loss vitality	
	biological position of trees	(%)	n	(%)	n	(%)
OP1	I	81	4	100	0	0
	II	18	4	100	0	0
	III	1	3	75	1	25
	Σ	100	11	92	1	8
OP2-OP6	I	48	15	75	5	25
	II	47	13	65	7	35
	III	5	7	35	13	65
	Σ	100	35	58	25	42

CONCLUSIONS

More intensive work on planting Austrian pine forests in currently called "Teslić" forest management area started after the Second World War. Planted forests of Austrian pine and Scots pine in this area cover the surface of 5,549 ha, which is 18% of the surface under Austrian pine and Scots pine planted forests in the Republic of Srpska. Although thinnings are planned to be done starting from 15 years of age according to the Forest Management Plans, in most cases tending measures of planted forests were left out. The development of pine planted forests was left to the actions of natural factors. Great deviations of the established stand structure elements in the unthinned stands compared to the situation in the thinned stands are evident. The unthinned stands at the studied age have a considerably larger number of trees and smaller mean diameter than the thinned stand i.e. than the optimal structure of stands at the studied age.

Following the IUFRO classification of trees, and compared to the thinned stand, unthinned stands are characterized by low vitality of trees and a considerable number of trees which are by their silvicultural role harmful for the selected trees. The trees from the unthinned stands have a considerably worse quality of bolewood. Based on the established slenderness ratio, in the unthinned stand the situation is unfavorable i.e. the stands are unstable, so during carrying out potential thinning activities in these stands there is a considerable risk of the influence of snow and wind (snow break and windfall wood) and great caution is necessary. Testing tree vitality on diameter increment i.e. the width of growth rings showed that, contrary to the thinned stand which has very good vitality, the stands which were not thinned during their development have bad vitality.

There are numerous reasons for inadequate treatment but they can't be an excuse i.e. unfavorable current condition of Austrian pine forests in the territory of "Teslić" forest management area (high cost of harvesting during silvicultural activities in the forests, fragmentation of plots where the forests were planted, unresolved property matters on the considerable part of the surfaces...). In order to improve the condition when Austrian pine planted forests in the studied area are in question, it is urgent to

intensify work on tending the stands i.e. carrying out thinning activities. Further afforestation without carrying out thinning activities, especially on the stands which are suitable for other production species is unjustifiable and leads to the aggravated condition of the forests in this area.

REFERENCES

- Begović B. (1986). Eksploatacija šuma i razvoj industrijske prerade drveta na području Usorsko – Tesličkog regiona za vrijeme Austrougarske uprave u Bosni i Hercegovini, Savez inženjera i tehničara šumarstva i industrije za preradu drveta BiH, Sarajevo.
- Jović G. (2012). Razvojno-proizvodne karakteristike kultura crnog bora u Teslićkom šumsko-privrednom području, [Magistrski rad], Šumarski fakultet, Banja Luka.
- Jović G., Petrović D., Dukić V. (2012). Tree growth models of Austrian pine cultures in the forest management area “Teslić”, International Scientific Conference – Forestry science and practice for the purpose of sustainable development of forestry - 20 years of the Faculty of forestry in Banja Luka.
- Kesterčanek F. (1897). Kroz Bosnu i Hercegovinu, Šumarski list, br 9 i 10, str. 399 - 432, Zagreb.
- Maunaga Z. (1999). Strukturne i proizvodne karakteristike veštački podignutih sastojina smrče u Republici Srpskoj, [Doktorska disertacija], Šumarski fakultet Univerziteta u Beogradu, Beograd.
- Pintarić K. (1991). Uzgoj šuma II dio, Udžbenik, Šumarski fakultet Univerziteta u Sarajevu, Sarajevo.
- Preuhler T. (1991). Storm damage in a Norway spruce stand on the Munich gravel plain. Allgemelne Forstzeltschrift, br 46, str. 1098-1103. Springer-Verlag.
- Stamenković V., Vučković M. (1988). Prirast i proizvodnost stabala i šumskih sastojina, Udžbenik, Šumarski fakultet Univerziteta u Beogradu, Beograd.
- Vučković M., Stajić B., Radaković N. (2005). Značaj monitoringa debljinskog prirasta sa aspekta bioindikacije vitalnosti stabala i sastojina, Šumarstvo, Udruženje šumarskih inženjera i tehničara Srbije, br 1 - 2, str. 1 - 10, Beograd.

PHYSIOLOGICAL VITALITY OF NORWAY SPRUCE SEEDLINGS ON REFORESTED AREA AT MT. KOPAONIK IN SERBIA

Djukić Matilda*, Djunisijević Bojović Danijela, Grbić Mihailo, Marković Marija, Skočajić Dragana

*Corresponding author: matilda.djukic@sfb.bg.ac.rs

Djukić M., Djunisijević Bojović D., Grbić M., Marković M., Skočajić D. (2015). Physiological vitality of Norway spruce seedlings on reforested area at Mt. Kopaonik in Serbia. In: Ivetić V., Stanković D. (eds.) Proceedings: International conference Reforestation Challenges. 03-06 June 2015, Belgrade, Serbia. pp. 194-200.

Abstract: Several sections on the road from Brzeće to the top of Mt. Kopaonik (Serbia) are very endangered by snowdrifts. For that reason, an area of 20 hectares was reforested with 2+2 Norway spruce (*Picea abies* Karst.) nursery stock. Seedlings were planted with 3.000 plants/ha. The analysis of physiological vitality of seedlings (25 plants from each of 30 randomized experimental plots) was done 2 and 14 years after outplanting.

Physiological vitality of seedlings was evaluated by determining survival percentage, chlorosis presence and measuring height, root collar diameter at young plants or diameter on breast height at older plants, needle mass and length and needle nutrient content (N, P, K, Mg). Two years after outplanting, seedling survival was 88%. However, the analysis of needle nutrient content indicated a low deficiency of N and Mg. Higher degree of chlorosis decreased spruce seedlings needle mass and length.

Fourteen years after outplanting, survival was still high (82%) and trees had an average height of 4.54 m and stem diameter at breast height of 7.78 cm. Needle nutrient content was good and chlorosis was absent. The analysis of spruce seedling physiological vitality show that lower vitality with various degrees of chlorosis was recorded only in early stage of development after outplanting and was probably caused by transplantation stress and root damage. It could be concluded that root development is probably the most important in nursery stock production and reforestation successes.

Key words: reforestation, Norway spruce, *Picea abies*, physiological vitality, chlorosis.

INTRODUCTION

The locality "Rendara" on the Mt. Kopaonik is characterised with severe winters, strong winds and snow drifts, with the lowest average annual temperature and duration of snow cover is about 160 days per year (Veljković et al. 1990). Because the traffic was at risk by snow and wind the reforestation of this area was done.

Mt. Kopaonik is characterised with very proper altitudinal arrangement of vegetation. Spruce forests dominate from 1550 to 1750 m above sea level (Mišić et al. 1985).

This area has special climatic characteristics by the coldest and longest winters in Serbia (negative monthly temperature from December to April) with the lowest mean annual temperature. The mean annual air temperature is about 3.0° C. The coldest month is January with - 6.0° C and the warmest August from 11.9° C. Absolute daily maximum rainfall is 76.5 mm. Average numbers of days with snow cover is 163.6, the maximum height of snow cover is about 2 m. The most frequent winds of an average year are blowing from the southwest direction and from the northeast (Smailagić 1995). At the locality was found decomposing bedrock where it formed brown podzolic soil depth of 40-80 cm.

The most favourable conifer forest species is Norway spruce, very common in Serbia in the higher parts of mountains as well as in the whole North hemisphere. It can reach in height more than 40 m and about 1 m in diameter. Root is not deep, grows in soil surface area and has good developed lateral roots.

The analysis of spruce seedlings that were used for reforestation was done on the site "Rendara", located in the National Park Kopaonik, near city of Brus (43°19'42.28" N; 20°51'04.02" E), elevation from 1,492 m to 1,540 m, slope of about 10% to 22%, the total area of 20 hectares. On this area it used to be a dense spruce forest which was destroyed years ago.

During afforestation and reforestation activities as well as in young conifer plantations the needle chlorosis appearance is very common (Komlenović et al. 1969). It could be the reason of low physiological vitality and susceptibility to diseases and pest attack. To avoid these unfavourable factors it is necessary to know the physiological mechanisms of plant nutrition, adoption and use of mineral elements and plant genetically specificities (Djukić et al. 2004).

The aim of this research was to find out the reason of chlorosis in young spruce plants after reforestation and to observe the possible influence on further plant physiological vitality, growth and development after 16 year period of monitoring.

MATERIAL AND METHODS

Spruce nursery stock for reforestation age of 2+2 years (2 years in the nursery bed and then transplanted and grown 2 more years), were produced from seed provenance of Mt. Tara in local forest nursery at the altitude which is similar to locality on Mt Kopaonik. Reforestation has been done with a total of 3,000 plants per hectare. Spacing between plants was 2.5 m.

The analysis of physiological vitality properties: spruce seedlings survival, chlorosis degree, plant height and diameter, mass of 100 needles, needles length, and macronutrients content were analyzed two and fourteen years after outplanting at the end of vegetative season. Analysis was carried out on 30 experimental plots with 25 plants on each plot, selected by the method of randomized blocks.

The evaluation of physiological vitality was done on the bases of needles chlorosis degree (intensity of green colour) as well as number of needles on the chlorotic branches expressed in percents: grade 5 – without chlorosis (colour intensive green, needles very dense), grade 4 - 10-30% of plant needles with chlorosis (colour green –

yellow, needles dense), grade 3 - 30-50% of needles with chlorosis (colour yellow, needles more less dense), grade 2 - 50-80% of needles with chlorosis (colour intensive yellow, needles sparse, youngest branches almost dry), grade 1- over 80% of needles with chlorosis (colour very intensive yellow, needles very sparse, youngest branches mostly dry).

One and two year old needle samples were collected from 5 seedlings of every of 5 chloroses degree from each of experimental plot, at the end of vegetative season. Samples were dried in oven at the temperature of 105°C. Content of nitrogen was determinated by Kjeldahl method, phosphorous by colorimetric, potassium and magnesium by flame-photometric method.

Statistical analysis was processed wit data STATGRAPHIC. The conclusions were made on the basis of analysis of variance (ANOVA) and LSD test was used to determine significant differences among mean values of the treatments ($p < 0.05$).

RESULTS AND DISCUSSION

Two years after outplanting seedling survival was 88% and 12 years later 82% which can be considered as a very good success (Figure 3).

The analysis of physiological vitality of plants two years after outplanting show needle chlorosis of various intensity on 42% of analysed plants (Figure 1). The most of chlorotic seedlings were at grade 4 (20%), less at grade 3 (10%), grade 2 (8%) and the least at grade 1 (4%) (Table 2). Chlorosis could probably be the reason of decreased spruce seedlings growth and development, because the height, root collar diameter, needle mass and length were in correlation with chlorosis degree (Table 1). Plants without chlorosis were significantly higher (52.6 cm) than those with expressed clorosis (40 cm). These plants had also larger root collar diameter (2.24 cm), needle length (9.4 mm), dry needle mass (0.32 g) compared to plants with the worst chlorosis degree (1.42 cm, 4 mm, 0.18 g, respectively) (Table 1). However, this could be the consequence of transplantation stress and damage of the root system due to outplanting (manipulation in nursery, transport and planting) so root could not supply enough water and minerals.



Figure 1. Spruce twigs with 1-5 chlorosis degree 2 years after outplanting



Figure 2. Spruce twigs of seedlings 14 years after outplanting

The analysis of growth and physiological vitality that was done 14 years after outplanting shows that it was very good. Collected data show that height mean value was 4.54 m, and diameter mean value 7.78 cm (Figure 4). It was observed that average needle length was 18.6 mm and needle mass 0.48 g (Table 1). All macronutrients were in good level and there were no chlorosis at all (Table 2, Figure 2). This probably means that spruce have a good potential for root regeneration and adaptation.



Figure 3. Spruce seedlings on reforested area 2 years after outplanting

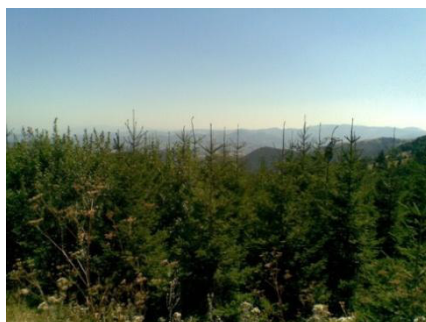

Figure 4. Spruce seedlings on reforested area 14 years after outplanting

Table 1. Average spruce 2+2 nursery stock morphometric properties 2 and 14 years after outplanting.

CHLOROSIS DEGREE	PLANT %	PLANT HEIGHT cm	PLANT DIAM. cm	NEEDLE LENGHT mm	NEEDLE DRY MASS g
2 years after outplanting					
5	58	52.16 a	2.24 a	9.4 a	0.32 a
4	20	50.22 a	1.88 a	6.0 b	0.28 b
3	10	48.02 b	1.68 b	7.8 c	0.26 b
2	8	46.40 b	1.56 b	8.0 c	0.24 b
1	4	40.00 c	1.42 c	4.0 d	0.18 c
4 years after outplanting					
5	100	454.00 a	7.78 a	18.6 a	0.48 a

Different letters indicate significant difference between means at 95% level on the bases LSD test.

The analysis of nitrogen, potassium, phosphorous and magnesium content in needles in younger plants, two years after transplanting, show that content of these macronutrients were at the level of good supply in the needles of plants at chlorosis degree 4 and no chlorosis (grade 5) while at other (grade 1-3) it was proportionally less. Chlorosis was evidenced at older and younger needles (table 2). It was observed relatively slow deficiency of N and Mg content (Table 2). Chlorosis means insufficient chlorophyll content and together with less number of needles cause less photosynthetic production and growth rate. Chlorosis could appear because of lack of nitrogen and magnesium but also of some other micronutrients such is manganese. It could appear when disturbance of chlorophyll synthesis or destruction of current chlorophyll molecules in chloroplasts. Chlorophyll is sensitive to any factor that influence normal biochemical and physiological

PROCEEDINGS
International Conference **REFORESTATION CHALLENGES**
03-06 June 2015, Belgrade, Serbia

processes in plant as photosynthesis, water regime, and energy supply, hormone balance and other (Djukic 1990).

Table 2. Average content of nitrogen, phosphorous, potassium and manganese in one and two year old needles of various chlorosis degree in spruce 2+2 nursery stock two and fourteen years after outplanting.

CHLOROSIS DEGREE	N %		P ₂ O ₅ %		K ₂ O %		MGO %	
	1.year needles	2.year needles	1.year needles	2.year needles	1.year needles	2.year needles	1.year needles	2.year needles
	2 years after outplanting							
5	1.64 a	1.82 a	0.82 a	0.84 a	0.97 a	0.91 a	0.181 a	0.187 a
4	1.22 b	1.36 b	0.69 b	0.63 b	0.59 b	0.66 b	0.164 b	0.172 a
3	1.14 b	1.49 b	0.31 c	0.42 c	0.78 a	0.87 a	0.162 b	0.170 a
2	1.02 c	1.18 c	0.24 c	0.36 c	0.69 b	0.73 b	0.146 c	0.171 a
1	0.96 c	1.02 c	0.19 d	0.23 d	0.62 b	0.64 b	0.118 d	0.162 b
average	0.99		0.21		0.63		0.140	
	14 years after outplanting							
5	1.80	1.84	0.86	0.88	1.06	1.08	0.188	0.188
average	1.82		0.87		1.07		0.88	

Different letters indicate significant difference between means at 95% level on the bases LSD test.

It is well known that there are a great specificity of macro and micronutrient metabolism in various woody plant species and intraspecific taxa. For example, it was recorded that nitrogen metabolism, according to nitratereductase enzyme content in leaves dry matter, was more similar in broadleaved tree species than in spruce (Gebauer and Schulce 1997).

Mineral nutrition is the most efficient method for nursery stock and forest trees quality improving as well as biomass production and to shorten of production period significantly (Ingestad 1973). This could prevent chlorosis appearance in the period after outplanting and influence better plant vitality, growth and development.

It is also important to use the best quality nursery stock and especially take care of root development during production, manipulation in nursery and planting in the field during reforestation in particular on sites with low soil quality.

A good survival, growth and development with later absence of chlorosis on reforested area on Kopaonik Mt. was supported with optimal water supply according to lot of snow during the winter time. A balanced water regime of spruce plants is of the great importance for the adoption, utilization of mineral elements and consequently for the growth and development (Djukić et al. 1996, George and Marschner 1996).

It was observed that development of spruce plants reduced the number of ground flora and 14 years after outplanting it appears much smaller number of species. The second reason was probably lower soil pH that is unfavourable for the most herbaceous plant species that were previous present on this area. It was recorded that pH in the 0-5 cm soil level was significantly lower under 15 years old pine forest compared to grassland (Alfredsson et al. 1998). Alriksson and Olsson (1995) recommended constant monitoring of soil changes (pH and base saturation level) under conifer afforested area.

In these activities it is very important to make adequate seedling selection, provenance, seedling quality (proper type, size, age, type of propagation), site preparation, techniques of planting and care measures after planting. In Ireland it was investigated the effect of site preparation on below and above ground biomass production by young trees of *Picea sitchensis* (Bong.) Carr. Site preparation techniques studied included different mounding and drainage methods and combinations of these two. The results showed that mound planted trees had greater total biomass production, greater stem biomass and DBH, as well as greater foliage biomass, compared to trees planted on the flat. This was probably due to improved weed control and more favourable soil temperature and moisture condition within the planting mounds (Wills et al. 1999).

In reforestation activities on analyzed area the most conditions were fulfilled, proper size and age of seedlings, adequate provenance and planting methods. Nevertheless, care measures after planting could be improved by mineral nutrients because experience with fertilization of spruce seedlings showed that the addition of basic macro elements can significantly improve the growth and physiological vitality (Đukić et al. 2004, Wiesler 1997).

According to this research, it is possible to recommend reforestation with 2+2 spruce nursery stock, Tara provenance, in order to mitigate unfavourable microclimate. Reforested area on the site of a former spruce wood, now with spruce trees height over 4 m, can lower the intensity of very strong winds and thus cause decrease of snowdrifts on the road. It also retains grate amounts of water from rain and snow, which returns to the atmosphere by plant transpiration and soil evaporation, increases the relative air humidity and thus affects the microclimate of this site. Further growth and development of spruce plants will improve this favourable trend.

CONCLUSIONS

The analysis of Norway spruce seedlings survival and physiological vitality was done at the locality "Rendara" on the Mt. Kopaonik where they were used for reforestation and grown under severe climate.

It was found needle chloroses of various degrees, which was recorded two years after outplanting, did not influence significant of on their later physiological vitality, growth and development.

Fourteen years after outplanting, survival was still high (82%) and trees had an average height of 4.54 m and stem diameter at breast height of 7.78 cm. Needle nutrient content was good and chlorosis was absent.

This probably means that there were proper site conditions, soil quality, water supply as well as good potential for spruce seedling root regeneration and adaptation on outplanting stress.

Acknowledgement: This paper was realized as a part of the project 43007 financed by the Ministry of Education and Science of the Republic of Serbia within the framework of integrated and interdisciplinary research.

REFERENCES

- Alfredsson H., Condrón L.M., Clarholm M., Davis M.R. (1998). Changes in acidity and organic matter following the establishment of conifers on former grassland in New Zealand. *Forest Ecology Management* 112: 245-252.
- Alriksson A., Olsson M. (1995). Soil changes in different age classes of Norway spruce (*Picea abies* (L.) Karst.) on afforested farmland. *Plant and Soil* 168-169:103-110.
- Đukić M. (1990). Prilog unapredjenju mineralne ishrane sadnica i pošumljavanje. Zbornik radova sa savetovanja "Savremene metode pošumljavanja, nege i zaštite u očuvanju proširenju šumskog fonda Srbije". Aranđelovac, 125-133.
- Đukić M., Obratov D. (1996). Some water regime properties of Norway spruce (*Picea abies* Karst.) from the region of the National park Kopaonik. Monograph - Forest ecosystems of the National parks. Bajina Bašta, 226-230.
- Đukić M., Đunisijević D., Grbić M., Skočajić D. (2004). Uticaj prihranjivanja na rast jednogodišnjih sadnica smrče u različitim supstratima. *Glasnik Šumarskog fakulteta*, 89, Beograd, 103-113.
- Gebauer G., Schulze E.D. (1997). Nitrate nutrition in Central European forest trees. In: *Trees- Contributions to Modern Tree Physiology*. (Rennenberg H., Eschrich W., and Ziegler H., eds.). Backhuys Publishers, Leiden, The Netherlands. pp. 273-291.
- George E., Marschner H. (1996). Nutrient and water uptake by forest trees. *Zeitschrift für Pflanzenernährung und Bodenkunde* 159, pp. 11-21.
- Ingestad T. (1973). Comparison of nutrient properties in forest tree species. *Cen. an Tree inpr.*, Stockholm, Sec, 5/9, (5-9)
- Komlenović N., Martinović J., Miković S. (1969). Kloroza obične smreke u mlađim kulturama na području vriština. *Šum. List*, 3/4, Zagreb.
- Miši, V., Jovanović R., Popović M. (1985). Vegetacija Kopaonika. Studija sa vegetacijskim kartama, Prostorni plan NP Kopaonik. Zavod za urbanizam i prostorno planiranje. Beograd. 1-169.
- Smailagić J. (1995). Klima Kopaonika. Studija Republičkog hidrometeorološkog zavoda Srbije. Beograd, str. 126.
- Veljković V., Vandić D. (1990). Ugroženost saobraćajnica i objekata od snežnih nanosa i vetra na Kopaoniku i potrebe zaštite. Zbornik radova sa naučnog skupa: "Priroda Kopaonika- zaštita i korišćenje". Institut za turizam PMF, 277-282.
- Wills J.M., Sundström E., Gardiner J.J., Keane M. (1999). The effect of cultivation technique on root and shoot biomass production by young Sitka spruce (*Picea sitchensis* (Bong.) Carr.) trees on surface water gley soils. *Plant and Soil* 217: 79-90.
- Wiesle, F. (1997). Agronomical and physiological aspects of ammonium and nitrate nutrition of plants, *Z.Pflanzenernähr. Bodenk* 160, 227-238.

Session 4:

PLANTING AND SEEDLING-SITE INTERACTION

INNOVATIVE SOIL CONDITIONING AND MULCHING TECHNIQUES FOR FOREST RESTORATION IN MEDITERRANEAN CONDITIONS

Coello-Gomez Jaime*, Fuentes-Boix Carla, Pique Míriam

*Corresponding author: jaime.coello@ctfc.es

Coello-Gomez J., Fuentes-Boix C., Pique M. (2015). Innovative soil conditioning and mulching techniques for forest restoration in Mediterranean conditions. In: Ivetić V., Stanković D. (eds.) Proceedings: International conference Reforestation Challenges. 03-06 June 2015, Belgrade, Serbia. Reforesta, pp. 201-210.

Abstract: In the framework of Sustaffor project (FP7-Research for SMEs, 2013-2015) a network of 8 field trials was installed, comprising almost 4,000 trees in four strongly contrasted bioclimatic areas: Semiarid, Mediterranean continental, Mediterranean humid and Montane.

These trials aim at assessing the individual and combined effects of innovative novel techniques targeting at improving the environmental, technical and economic outcomes of tree planting projects at Mediterranean and temperate conditions. These techniques were developed by 4 European SMEs:

- A new soil conditioner developed by TerraCottem Internacional, with an improved mixture of hydroabsorbent polymers, root growth precursors and fertilizer: this technique improves water and nutrient availability at micro-site level, being an alternative to existing soil conditioners, soil amendments and emergency irrigation.
- Four new mulching models: two versions of a new biopolymer-based biodegradable mulch (DTC); a woven jute biodegradable mulch treated with bio-based resins for enhanced durability (La Zeloise) and a long-lasting (reusable) mulch made with recycled rubber (EcoRub). These models pretend to avoid weed competition during the first years of plantation, being an alternative to chemical or mechanical weeding and to plastic mulching.

We present and discuss the performance of these novel techniques, compared to reference ones, during the first vegetative period (2014) on tree survival, growth & physiology and soil moisture. The novel techniques have proven to be a feasible alternative under different circumstances: soil conditioner was especially effective in limited sites (semiarid and montane) while mulching resulted in noticeable gains at the most productive sites (Med continental and Med humid).

Key words: eco-innovation, environmental friendly, groundcovers, SMEs, biodegradable.

INTRODUCTION

Mediterranean areas are characterized by a period of water shortage during summer, which is the most critical phase for a newly established reforestation because of

the combined effect of high temperatures and low water availability (Vallejo et al. 2005). The extent and intensity of this dry period varies largely with the physiography, latitude and altitude. The impact of drought is expected to worsen in the upcoming decades in the context of climate change, with projected longer and more severe episodes of high temperatures and a more irregular distribution of precipitation (Resco de Dios et al. 2007). In other temperate and wetter regions such as Central Europe it is expected that drought will also become a seasonal phenomenon, accompanied by a rise of temperatures (IPCC, 2007). The negative effects of drought on young trees include losses of growth and vigour and ultimately the death of the seedling.

Competitive vegetation, especially herbaceous species, can exacerbate the negative effect of drought on juvenile trees (Olivera et al. 2014). This vegetation can intercept most water from a scarce rain episode, typical in Mediterranean conditions, and reduce considerably soil water reserve especially during spring season.

The single or combined effect of drought (especially in areas with poor precipitation and limiting physiography, but of growing importance elsewhere) and competitive vegetation (especially harmful in medium to high quality sites) results in the failure of many reforestation projects unless appropriate techniques are applied. The other major menace in our conditions is browsing damage from growing herbivore populations.

Most plantation techniques aim at mitigating the effects of drought or weeds independently, resulting in a general decrease in their effectiveness. Moreover, they often rely on recurrent interventions, implying a massive use of resources: emergency or periodic watering against drought, mechanical and chemical weeding against competitive vegetation, etc. The high costs and the need to program these interventions often lead to their inapplicability, especially in poorly accessible sites. Moreover, the environmental impact of some of these practices, especially herbicide application, raises increasing social concern and legal restrictions (Willoughby et al. 2009).

The success of modern reforestations in Mediterranean conditions, and to be increasingly considered in Central Europe, require an integrative approach to overcome the negative effects of both drought and weeds with the development of cost-effective (considering purchase, transport, install and disposal costs) and environmentally friendly techniques with durable effect. With this intention, this study aims at evaluating the effect of innovative plantation techniques in young reforestations:

- new soil conditioners, aiming at improvement conditions at micro-site level, in terms of water and nutrients availability and soil properties (Sloup and Salaš 2009);
- innovative mulching techniques based on biodegradable and/or recycled materials, avoiding weed growth and proliferation besides the tree and mitigating soil water evaporation (Barajas-Guzmán et al. 2011, Maggard et al. 2012).

These techniques are evaluated alone and combined, and compared to reference ones, i.e., those currently applied for the same purpose, across a range of four strongly contrasted bioclimates in NE Spain: Semiarid, Mediterranean Continental, Mediterranean Humid and Montane. These techniques pretend to complement a successful reforestation, based on an adequate choice of species, provenance and seedling quality, continuing with a proper soil preparation and a satisfactory protection against herbivores.

MATERIALS AND METHODS

Field trials description

This study is performed in four field trials (Table 1) installed in NE Spain in early 2014.

Table 1. Main features of field trials.

Bioclimate	Semi-arid	Med continental	Med humid	Montane
Location name	<i>Mequinenza</i>	<i>Solsona</i>	<i>Banyoles</i>	<i>Fontanals</i>
UTM (N31) coordinates	261.245, 4.580.245	378.506, 4.651.456	477.893, 4.660.733	412.053, 4.693.256
Altitude	210 m	672 m	215 m	1,430 m
Site type	Forest area burnt in 2005	Abandoned arable field	Abandoned arable field	Abandoned grazing area
Aspect, slope	South, 40%	Flat	Flat	North, 30%
Mean annual temp.	15.0°C	12.0°C	14.0°C	7.5°C
Mean annual prec.	371 mm	683 mm	872 mm	887 mm
Mean summer prec.	69 mm	165 mm	213 mm	272 mm
Climate type (Köppen)	BS: Steppe climate, cold	Csb: temperate, dry mild summer	Cfb: Maritime temperate	Cfc Temperate/ Dfb Continental
Soil texture	Loamy-sandy	Loamy-clayish	Loamy-silty	Loamy-sandy
Species chosen	Aleppo pine (<i>Pinus halepensis</i>)	Hybrid walnut (<i>Juglans x intermedia</i>)	Hybrid walnut (<i>Juglans x intermedia</i>)	Mountain ash (<i>Fraxinus excelsior</i>)

Experimental design of each field trial

The experimental design follows an incomplete factorial scheme, with combinations of soil conditioning and weeding techniques (Table 2) resulting in a total of 17 treatments (Table 3). Each treatment is applied to 30 trees per field trial, distributed following a full random block design, with 6 blocks per treatment.

Table 2. Soil conditioning and weeding techniques applied.

Technique	Description	Code
Soil conditioners	Innovative soil conditioner comprising 23 ingredients including a new complex of hydroabsorbent polymers	ISC20
	Utilized at 3 doses: 20, 40 and 80 g/tree	ISC40
	Commercially available soil conditioner TerraCottem Universal®. Dose: 40 g/tree	CommSC40
	No application of soil conditioner	NoSC
Weeding techniques*	Black new biopolymer-based frame, 100% biodegradable, fused to a commercially available black biodegradable film	BIOFRA
	Woven jute cloth treated with furan bio-based resin for increased lifetime, 100% biodegradable	JUTE
	Recycled rubber based mulch, anti-UV treated, reusable in successive tree plantation projects, 1.5 mm thick,	RUBBER
	Commercial black polyethylene film, anti-UV treated, 80 µ	CommPE
	Commercial green biodegradable woven biofilm	CommBF
	Herbicide application (glyphosate, 14.4 cm ³ /tree at 1.25%) applied in May via backpack sprayer**	CommHER
	No application of weeding	NoWeeding

* The weeded area per tree was 80x80 cm in Med continental and Med humid conditions, and 40x40 cm in Semi-arid and Montane conditions

** Herbicide was not applied in Semi-arid nor in Montane conditions, because of the absence of significant weed competition during 2014.

Table 3. Experimental treatments tested: combination of soil conditioning and weeding techniques. The implemented treatments are those indicated by an X.

Soil conditioner	ISC20	ISC40	ISC80	CommSC40	NoSC
Weeding technique					
BIOFRA		X			X
JUTE		X			X
RUBBER		X			X
CommPE	X	X	X	X	X
CommBF		X			X
CommHER		X			X
NoWeeding		X			X

Data gathering

During the first vegetative period (2014) weather was registered hourly with in-site stations recording temperature, precipitation, relative humidity, wind and solar radiation. Survival was assessed visually at the end of the vegetative period. Tree growth was calculated as the difference between tree volume at the end and at the beginning of the vegetative period. Basal diameter was measured with digital calliper while height was obtained with measuring tape. Tree volume (mm^3) was calculated as: $\text{Basal_radius}^2 \cdot \text{height} \cdot \pi \cdot 3^{-1}$, with all variables expressed in mm.

Tree water status was obtained 4 times (2 times in Med humid site) during summer, as needle relative water content (RWC) in pine, and as midday leaf water potential in broadleaves. RWC was obtained from 8 sets of 10-15 needles per treatment, and calculated as: $\text{RWC} = (\text{FW}-\text{DW}) \cdot (\text{SW}-\text{DW})^{-1}$; where FW is fresh weight, DW is dry weight (after 72 h at 70°C) and SW is saturated weight (after 24 h in distilled water). Midday leaf water potential was measured with pressure chamber, in 6 fully developed leaves exposed to sunlight from the upper crown from 6 different trees.

Soil moisture was measured with TDR probe guided through pre-installed access tubes. We performed 7 measurements (May, June, July - 2x, August - 2x, September) each at two different depths: 0-20 cm and 20-40 cm.

RESULTS

Weather

The summer of 2014 was much wetter than the historical average: in both August and September, precipitation was, for Semiarid, Med continental and Med humid conditions, above percentile 95 considering the last 35 years. Summer precipitation was, respectively, 151 mm (+120% with respect to the historical average), 258 mm (+56%) and 320 mm (+50%). Only in Montane conditions the summer precipitation was similar to historical mean (278 mm, +2%).

Tree survival

Survival rates were very high, over 99% with the only exception of Semiarid field trial (93%). In these conditions, the treatments including soil conditioner led to higher survival rates (95%) than those without this technique (90%).

Tree growth

The effect of the different treatments on tree growth varied significantly among the different conditions (Figure 1).

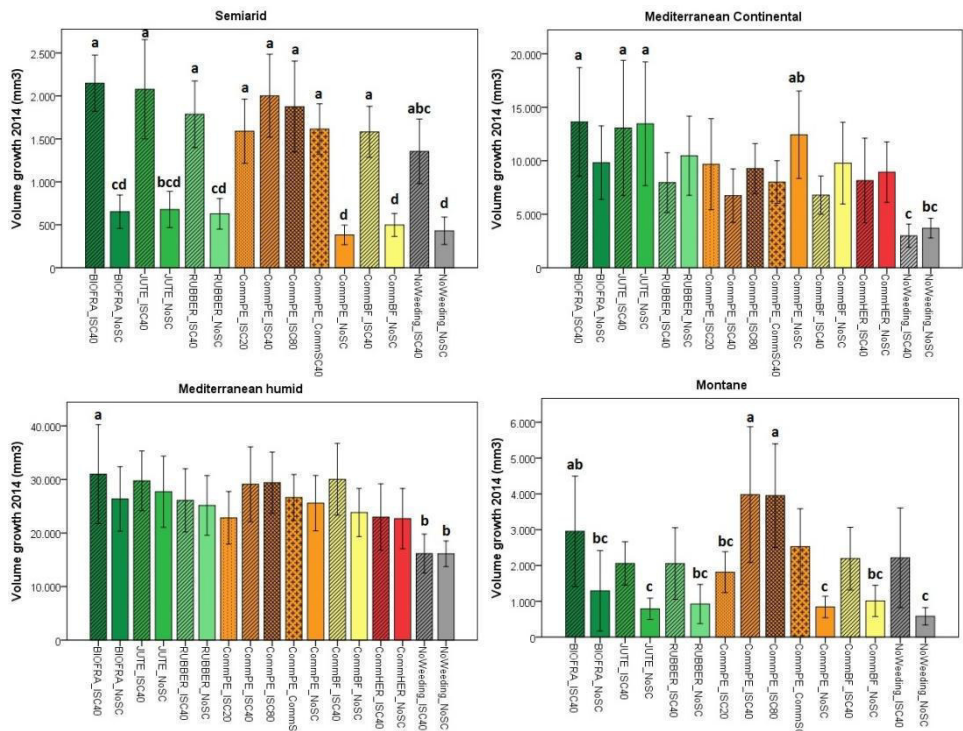

Figure 1. Seedling growth (mm³) during the first vegetative period. The different letters correspond to grouping based on Tukey test (p>0.05), for those treatments leading to results significantly different to others.

In Semi-arid site soil conditioning was the leading factor determining tree growth: the presence of any formulation or dose of this technique led to significantly higher tree growth than NoSC. There were no significant differences between the different products or doses. In these conditions weeding was also positive: CommPE ("a" group, according to Tukey test, p < 0.05, considering weeding treatments only), BIOFRA (ab) and JUTE (ab) resulted in higher tree growth rates than NoWeeding (c).

In Med Continental and Med Humid conditions soil conditioning did not affect tree growth significantly. However, weeding techniques had a clear effect: all weeding techniques except for CommBF in Med Continental and except for CommHER in Med Humid resulted in higher growth rates than NoWeeding. There were no significant differences between the different weeding techniques.

Finally, in Montane conditions soil conditioner applied in doses of 40 or 80 g had a significantly positive effect on tree growth: NoSC ("c" group, according to Tukey test, p < 0.05, considering soil conditioning treatments only) led to lower tree growth than ISC40

(b) and CommSC40 (b) and that ISC80 (a). In this site the only weeding treatment increasing tree growth with respect to NoWeeding was CommPE.

Tree water status

The effect of the different treatments on tree water status was especially dependent on the weeding treatment, while soil conditioner did not have, in general, a remarkable effect. Figure 2 shows the summary of results of tree water status for the different field trials, semi-measurement dates and weeding treatments.

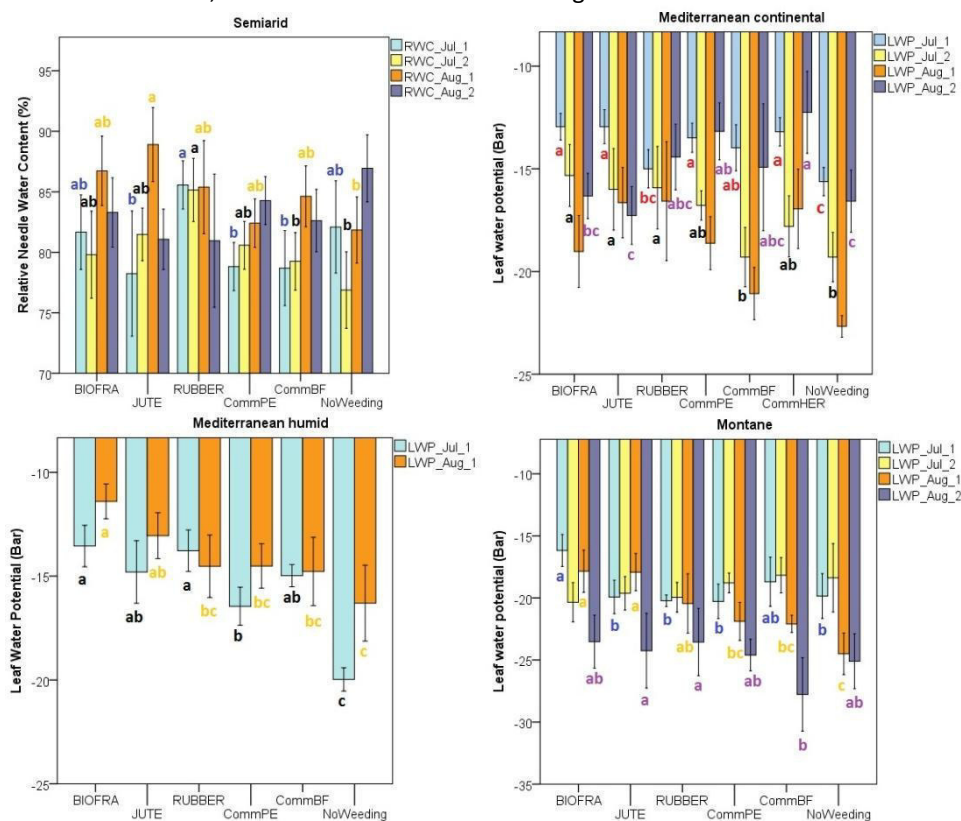

Figure 2. Tree water status at different moments of summer 2014. The different letters correspond to grouping based on Tukey test ($p < 0.05$).

In Semi-arid conditions RUBBER provided the overall best tree water status, superior to at least 2 alternative treatments in July measurements. JUTE also provided superior results to NoWeeding in the first August measurement. On the other hand, CommBF and NoWeeding resulted in lower Relative Water Content than RUBBER and/or JUTE in two of the measurements.

In Med Continental conditions the best water status was provided by CommPE and CommHER, which resulted in lower leaf water potential than the other treatments in at least one measurement. NoWeeding provided the poorest tree water status in all measurement except for one, when the treatments did not provide significant differences between them.

In Med Humid conditions the treatment resulting in best water status was BIOFRA, while NoWeeding resulted in the poorest tree water status. CommPE also led to results significantly worse than BIOFRA. Likewise, Montane conditions witnessed BIOFRA providing the best tree water status of all weeding treatments, together with JUTE and RUBBER, while NoWeeding and to a lesser extent CommPE and CommBF showed poorer tree water status.

Regarding the effect of soil conditioners on tree water status, the only difference found for all measurements and field trials was in the second measurement of August, when ISC80 led to higher tree water status than ISC20 in Semiarid and Med Continental sites.

Soil moisture

Soil moisture measurements provided few significant differences between treatments, among the measurements performed (Table 4).

Table 4. Significant differences of soil moisture between treatments found for all conditions, measurement date and soil depth.

Conditions	Date	Depth (cm)	Treatment(s) leading to higher soil moisture	Treatment(s) leading to lower soil moisture
Semiarid	May	0-20	JUTE	BIOFRA
	September		NoWeeding_ISC40, CommPE_NoSC, JUTE_ISC40, RUBBER_ISC40	NoWeeding_NoSC
Med Continental	August_2	20-40	JUTE	CommBF, NoWeeding, CommPE, CommHER
		0-20	BIOFRA, CommPE	CommHER
		20-40	JUTE_NoSC	CommHER_NoSC, CommHER_ISC40, NoWeeding_ISC40, CommPE_NoSC, CommPE_ISC20, CommPE_CommSC40
Med Humid	August_2	0-20	ISC40	CommSC40
Montane	July_2	0-20	BIOFRA	CommBF
	August_2		ISC40	CommSC40

The most common significant difference found in Semiarid and Med Continental conditions was JUTE mulching providing higher soil moisture than CommHER. In both Med Humid and in Montane conditions ISC40 resulted in higher soil moisture than CommSC40 in one measurement.

DISCUSSION

The abnormally high rainfall during summer 2014 reduced the intensity of the drought period typical from each site, posing a difficulty on extracting conclusions related to the performance of the different treatments in the bioclimates chosen.

The effects on tree growth were consistent and stable, with soil conditioner being the most relevant technique in Semiarid and Montane conditions and weeding techniques having a major positive effect in Med Continental and Med Humid sites, and a minor positive effect in Semiarid and Montane conditions.

Although very different in terms of climate, Semiarid and Montane field trials share three relevant features: the use of small mulches (40x40 cm), the predominant lack of weed competition during 2014 and a thick texture soil (loamy-sandy), with poor nutrient content and water retention capacity. In these circumstances, soil conditioners significantly improved tree growth, as found by Viero (2002). The additional gain in tree growth because of mulching (CommPE, JUTE and BIOFRA in Semiarid, CommPE in Montane) and tree water status (RUBBER and JUTE; BIOFRA, JUTE and RUBBER, respectively) in comparison with NoWeeding can be related with the effect of mulch on mitigating soil water evaporation (McConkey 2013). The positive results of CommPE in these sites in comparison with other mulching options can be associated with the incomplete factorial experimental design, where 80% of trees with CommPE included a soil conditioner (ISC20, ISC40, ISC80, CommSC40), while 50% of trees from other weeding treatments were combined with soil conditioner (ISC40).

Med Continental and Med Humid field trials share some features: they are both former agricultural fields with high quality conditions, planted with the same species, and subjected to severe weed proliferation. Weeding treatments resulted in significant growth increment compared to NoWeeding, while water-related variables followed the same trend although less manifestly.

CONCLUSIONS

Weeding and soil conditioning proved to be effective for enhancing tree growth and tree water status already during the first year of plantation and despite the partially masked effect of summer drought because of the abnormally high precipitation regime of 2014. The effect of the different treatments depended largely on site conditions:

- In conditions especially limited poor precipitation and/or thick textured soil with poor water holding capacity, soil conditioning significantly enhances tree growth. In these conditions, mulching can also enhance tree growth and water status, thank to the mitigation of soil water evaporation.
- In high quality sites, with rich soils well supplied with water and where weed competition is a major menace for reforestation, weeding results in significant growth gains since the first year, while soil conditioning does not lead to significant effects.

The innovative soil conditioner proved to be at least as effective as the commercial version, being a very promising alternative. Regarding the dose, the prescribed 40g/tree seems to be appropriate.

Among the evaluated weeding techniques, the novel mulches developed during Sustaffor project led in general to outcomes similar to polyethylene mulching and herbicide application, and often superior (especially in terms of tree water status and soil moisture) to the commercially available biofilm. With this regard, Jute mulch provided best results in Med continental and Montane conditions, Rubber mulch was especially effective in Semiarid and Montane sites and the new biopolymer-based framed mulch performed especially well in Med humid and Montane conditions. These new models might become a feasible alternative to current weeding techniques considering their technical, social and environmental advantages.

In any case, these results come from the first vegetative period, and thus they must be considered as preliminary. The monitoring of these experiences during the next years will allow assessing the effects of the different techniques in the mid term, including their performance under years with weather similar to the historical average, as well as their durability and service life

Acknowledgements: *The research leading to these results has received funding from the European Union's Seventh Framework Programme managed by REA-Research Executive Agency <http://ec.europa.eu/research/rea> (FP7/2007-2013) under grant agreement n° 606554. We are grateful to the staff participating in field trials install and monitoring and to the owners and managers providing the land for the experiments.*

REFERENCES

- Barajas-Guzmán M.G., Barradas V.L. (2011). Microclimate and sapling survival under organic and polyethylene mulch in a tropical dry deciduous forest. *Boletín De La Sociedad Botánica De México*, 88, 27-34.
- IPCC (2007). *Climate Change 2007: The Physical Science Basis. Contribution of Working Group II to the Fourth Assessment Report of the IPCC*. In: Parry ML, Canziani OF, Palutikof JP, Van der Linden PJ, Hanson CE (eds). Cambridge University Press, Cambridge, UK and New York, USA, 976 p.
- Maggard A.O., Will R.E., Hennessey T.C., McKinley C.R., Cole J.C. (2012). Tree-based Mulches Influence Soil Properties and Plant Growth. *HortTech.*, 22 (3), 353-361.
- McConkey T., Bulmer C., Sanborn P. (2012). Effectiveness of five soil reclamation and reforestation techniques on oil and gas well sites in northeastern British Columbia. *Can. J. Soil Sci.*, 92 (1), 165-177.
- Olivera A., Bonet J.A., Palacio L., Liu B., Colinas C. (2014). Weed control modifies Tuber melanosporum mycelial expansion in young oak plantations. *An. For. Sci*, 71(4): 495-504.
- Resco de Dios V., Fischer C., Colinas C. (2007). Climate change effects on Mediterranean forests and preventive measures. *New Forests* 33: 29-40.
- Sloup J., Salaš P. (2007). Affecting the quality of nursery produce by soil conditioners. *Acta univ. agric. et silvic. Mendel. Brun.*, 2009, LVII, No. 4, pp. 103–108.
- Vallejo R., Aronson J., Pausas J.G., Cortina J. (2005). Restoration of Mediterranean woodlands. 193–207 In: Van Andel J, Aronson J, (eds). *Restoration ecology: a European perspective*. Blackwell. 193-207. Science, Oxford, United Kingdom.

PROCEEDINGS
International Conference **REFORESTATION CHALLENGES**
03-06 June 2015, Belgrade, Serbia

- Viero P.W.M. (2002). The effect of a soil-amending hydrogel on Eucalyptus grandis establishment practices in the Zululand forestry region. MSc Thesis, Faculty of Forestry, Saasveld Campus, Port Elizabeth Technikon.
- Willoughby I., Balandier P., Bentsen N.S., McCarthy N., Claridge J. (eds.). (2009). Forest vegetation management in Europe: current practice and future requirements. COST Office, Brussels. 156 pp.

A PROPOSAL OF A SITE PREPARATION SYSTEM COMBINED WITH CHIPPING OPERATION

Yoshida Mika*, Fujiwara Masashi, Sakai Hideo

*Corresponding author: yoshida@fr.a.u-tokyo.ac.jp

Yoshida M., Fujiwara M., Sakai H. (2015). A proposal of a site preparation system combined with chipping operation. In: Ivetić V., Stanković D. (eds.) Proceedings: International conference Reforestation Challenges. 03-06 June 2015, Belgrade, Serbia. Reforesta. pp. 211-216.

Abstract: Plantation forests are mainly composed of coniferous trees that occupy about a quarter of total land in Japan. The age-class distribution has only one peak around 50 years old and this uneven-aged structure is one of the most problematic issues for Japanese future resource management and material supply. Clear cutting and planting are expected; however, the average expense for silviculture has equaled 6,849 EUR/ha under the 50-years rotation system to maintain clear cutting and replantation prescriptions. In this study, it is proposed that combining site preparations for forest fuel harvesting by using whole-tree logging system is an effective way to encourage replantation. Three different kinds of chippers were used for logging residues chipping at roadside after clearcutting. The average of chipping cost and gross profit were found to be 2,874.54 EUR/ha and 3185.53 EUR/ha, respectively. Compared to the cost components of silviculture cost in Japan, the gross profit could partly compensate for above overall silviculture cost but not all of it. Nevertheless, this result will encourage replantation by saving site preparation cost to generate extra revenue from logging residues as part of forest resource management.

Key words: chipping, logging residue, replantation, site preparation, fuel chip production.

INTRODUCTION

Plantation forests mainly composed of coniferous trees are the main resources for Japanese forestry business. These forests incredibly occupy about a quarter of Japanese land. The age class distribution is around 50 years old and its uneven-aged structure is problematic for future resource management and material supply. For sustainable use of forest resources, clear cutting and planting are expected while expensive silviculture cost and heavy workloads of site preparation prevent the progress of the forest regeneration dynamics. Thus, and related also to the downturn of timber price, the money flow of forestry cannot afford to pay the cost for silviculture under 50 years rotation system. The average expense for silviculture was said to 6,849 EUR/ha (880,000 JPN/ha) (Forestry Agency in Japan 2014).

Currently there is a new trend of resource management of wood material usage for energy use. The sudden rise of new wood demand as an energy resource is, in fact, estimated at 7.7 million round wood m³ annually (Forestry Agency in Japan 2014), which

can generate additional resources and revenue in Japanese forestry sector. The low quality round wood price has already reached to 54.5 EUR/tonne (7,000 JPN/tonne) by demand (Kuboyama 2014). Thus, full/whole tree logging methods are being reconsidered as a legitimate and efficient method to skid more biomass volume at one time instead of cut to length (CTL) system that cannot remove bulky logging residues – tree tops and branches – on forest land (Figure 1).



Figure 1. Cut-to-Length (CTL) system on a steep terrain leaving logging residues on forest land.

In the case of full tree logging, residues at landing site or near roadside can be removed and distributed for energy utilization while logging residues on forest land becomes obstacles for planting in the both cases of CTL and tree length logging systems. Therefore, the CTL/tree length logging systems require site preparation and advancement of silviculture costs because it is difficult to mechanize on uneven ground with large wood debris (Figure 2). Furthermore, the energy use of forest resources in Japan has a problem of its expensive transportation cost caused by the low bulk density of materials so that forest road side chipping for energy use was introduced to effectively realize both efficient transportation cost and full utilization of forest resources near the forest operations on site. This combination of whole-tree logging and roadside chipping after clearcutting will improve the money flow of forest business in addition to curtailing site preparation cost. There the cost and profit of this system after clearcutting is simulated in this study for evaluation and continue proposal under reasonable resource management.



Figure 2. Forested hillside site preparation (left), and terrain after site preparation (right).

MATERIALS AND METHODS

Clearcutting on a single-storied plantation forest was considered in this study. Whole-tree logging was considered to save site preparation cost on steep terrain conditions and even on flat terrain where soil condition was often too soft and non-load bearing for forestry vehicles to move and transport loads in Japan. Logging residues were concentrated and could be comminuted at roadside. Its average tree trunk volume V was set at 297 round wood m^3/ha (Forestry Agency in Japan 2014). The volume of residues after bucking V_r (round wood m^3/ha) was calculated by the equation (1):

$$V_r = V(1 - u + b) \quad (1)$$

where u was utilization ratio of log as timber product; and b was the ratio of branches and leaves for trunk volume. Utilization ratio u was assumed to be 0.7 and the ratio of branches and leaves b was 0.235 (National Institute for Environmental Studies, Japan 2014). Three different kinds of chippers, TP250 mobile turnable from Denmark, BR-120T from Japan, Farmi 380 from Finland, were compare here. TP250 is equipped with an internal engine (53.7 kW) and a feeder for manual loading (Figure 3), and tracked by small vehicles that move on poor spur roads. BR-120T is also equipped with an internal engine (141 KW) and requires a grapple loader for feeding. It is mounted on crawlers and can drive and mobilize on spur roads. Farmi 380 is a tractor attachment chipper, and the tractor, Valtra T193, has 140kW power and a self-loader. Their productivities were previously investigated, and summarized in Table 1.



Figure 3. Manual chipping of logging residues by using TP250 mobile turnable chipper.

Table 1. Chipping productivity and investigation data.

Chipper	Forest Material Structure	Mechanistic Feeding Type	Productivity (m^3/h)
TP250	Logging residue	Manual feeding	5.00
BR-120T	Logging residues and short logs (<1m)	Machine feeding	15.44
Farmi 380	Decayed short logs (<2m)	Machine feeding	22.00

The hourly cost C (EUR/hr) calculation formula was the equation (2):

$$C = ((P(1 - s) + m)/Y + a)/(YH) + w/g + f(1 + e) \quad (2)$$

where P was machine price (EUR); s , salvage ratio; m , maintenance ratio; a , annual administration ratio; Y , depreciation (years); H , the annual working hours (hours/year); w , hourly wage (EUR/hr); g , productive hour ratio; f , hourly fuel cost (EUR/hr); and e was lubricant ratio in proportion to fuel cost. Since the real chip price c (EUR) is not fixed yet in the real markets, chip price was set at 54.48 EUR/tonne (7,000 JPN/tonne) in this study although it was round wood material price (Kuboyama 2014). Gross profit G (EUR/ha) obtained by chip production was calculated by the equation (3):

$$G = d_a d_b c V r - d_a d_b C V r / p \quad (3)$$

where d_a was the weight density coefficient for chip volume (tonne/m³); d_b , the chip volume density coefficient for round wood volume (m³/round wood m³); and p chipping productivity (m³/h). The factors of chippers and for calculation were summarized (Table 2), and the currency ratio used in this study was 128.48 JPN/EUR (as of 13, March, 2015).

Table 2. Material factors.

	TP250	BR-120T	Farmi380
Tree trunk volume, V (m ³ /ha)	297	297	297
Utilization ratio, u	0.7	0.7	0.7
Ratio of branches and leaves for trunk volume, b	0.24	0.24	0.24
Power (kW)	53.7	141	140
Price, P (EUR)	72,257	*264,627	255,976
Salvage ratio, s	0.1	0.1	0.1
Maintenance ratio, m	0.5	0.5	0.5
Yearly administration ratio, a	0.1	0.1	0.1
Depreciation years, Y (years)	5	5	5
Yearly working hours, H (hours)	2000	2000	2000
Wage, w (EUR/hr)	13.82	13.82	13.82
Productive hour ratio, g	0.7	0.7	0.7
Hourly fuel cost, f (EUR/hr)	7.5	28.47	20.45
Lubricant ratio, e	0.2	0.2	0.2
Chip price, c (EUR/tonne)	54.5	54.5	54.5
Weight density coefficient, d_a (tonne/m ³)	0.25	0.25	0.25
Chip volume density coefficient, d_b (m ³ /round wood m ³)	2.8	2.8	2.8
Chipping productivity, p (m ³ /hr)	5	15.44	22
Chipping cost (EUR/ha)	3853.4	3004.86	1765.36
Gross profit, G (EUR/ha)	2206.66	3055.21	4294.7

*Includes an external grapple loader cost, 77,831.35 EUR.

RESULTS AND DISCUSSION

The cost components of silviculture cost were summarized (Table 3). The cost for site preparation is high and occupied a large portion of silviculture expenses. The revenue by selling produced chip at roadside became 6,060.07 EUR/ha (778,615 JPN/ha). The logging residues chipping cost and gross profit *G* of each chippers were also summarized Table 2. The average of chipping cost and gross profit *G* were 2874.54 EUR/ha (369,329 JPN/ha) and 3185.53 EUR/ha (409,285 JPN/ha), respectively. These results confirmed that it is possible to get profit from chipping operations for energy utilization regimes, and the profit increased with increasing chipping productivity. In addition, the cost for site preparation could be saved by introducing whole-tree logging systems. Compared to the overall components of silviculture cost, it is possible to compensate bareroot plant purchase cost and/or manual planting cost by selling chip from logging residues. However, there was a case that the cost for container plant or site preparation was not compensated.

Table 3. Summary of overall breakdown of silviculture costs

Container plant purchase cost (EUR/ha)	Bare root plant purchase cost (EUR/ha)	Planting cost (EUR/ha)	Site preparation cost (EUR/ha)
3847.98	2152.82	1460.62	4472.66

*These data are the average values from Shinrin Kankyo Realize Co., Ltd. 2015, and planting 3,000 plants/ha were assumed.

**Hearing investigation from personal communication via a forestry company.

Improving chipping productivity is one of the ways to increase gross profit. However, the capital cost of a productive chipper is usually high, and it requires a large amount of material to keep it continually working (Harrill and Han 2010, Yoshida and Sakai 2014). To achieve such a productive chipper, chipping of logging residues after clearcuttings might be an additional operation for revenue besides its core chip supply to wholesale business. Therefore, the lowest investment chipper, such as TP250 mobile turnalbe, is suitable to introduce into the proposed system. Machine ownership system also must be considered, for example, sharing or lease of productive chippers in a local area will be another solution. Furthermore, chipping is now practiced widely in all over Japan but the materials utilized and consumed are usually selected for high quality. However, the study reveals that worse materials should be tried as well, and the proposed system should be practiced according to each operational conditions including quality of forest materials to process and consume.

CONCLUSION

This pilot study encourages plantation after clearcutting by saving site preparation cost via extra revenue from logging residues. Although it was not always enough to compensate the whole silviculture cost, utilization of forest residuals can add revenue when operationally efficient and established. Furthermore, the proposed system can be put into practice immediately because the chipping system has already existed.

Moreover, since the site preparation cost shares a large portion of silviculture cost, the proposed system will become more realistic at many managed forest sites by investigating the effect of local characteristics such as terrain and soil conditions, as well site productivity classes.

REFERENCES

- Forestry Agency in Japan (2014). Annual report on forest and forestry in Japan, fiscal year 2013. Forestry Agency in Japan.
- Harrill H., Han H.S. (2010). Application of hook-lift trucks in centralized loggingslash grinding operations. *Biofuels* 1 (3): 399-408.
- Kuboyama H. (2014). The expand of forest biomass electricity generation, no. 3. In *Green & life 2014 winter*. Nourin-tyuo-kinko, (In Japanese and title was translated by author).
- National Institute for Environmental Studies, Japan (2014). National greenhousegas inventory report of Japan. Technical report, Ministry of the Environment, Japan, Greenhouse Gas Inventory Office of Japan, Center for Global Environmental Research, National Institute for Environmental Studies, Japan.
- Shinrin Kankyo Realize Co., Ltd. (2015). Report of low cost reforestration trials, Promotion project for introduce and evaluate low cost reforestration techniques. Shinrin Kankyo Realize Co., Ltd., (In Japanese and title was translated by author).
- Yoshida M., Sakai H. (2014). Importance of capital cost reduction of chippers and their required productivity. *J. For. Res.* 19 (4): 361-368.

**LIGHT NEEDS FOR SEED GERMINATION AND EARLY DEVELOPMENT OF
SEEDLINGS IN CORK OAK (*QUERCUS SUBER* L.)**

Marras Tatiana*, Canali Federico, Vessella Federico, Schirone Bartolomeo

*Corresponding author: tatianamarras@unitus.it

Marras T. *, Canali F., Vessella F., Schirone B. (2015). Light needs for seed germination and early development of seedlings in cork oak (*Quercus suber* L.). In: Ivetić V., Stanković D. (eds.) Proceedings: International conference Reforestation Challenges. 03-06 June 2015, Belgrade, Serbia. Reforesta. pp. 217-226.

Abstract. Seed germination and seedling development of cork oak have specific light needs in terms of photoperiod, light quantity and quality. To reproduce optimal light conditions in a controlled environment, these parameters were analyzed in a mature cork forest in Central Italy (Viterbo) from November 2014 to the spring 2015. The species range has a photoperiod between from 9h52'01" (NW) and 15h15'17" (SE); the total daytime is 4859 h in the northernmost point and 4762 h in the southernmost. In Viterbo, during the period of analysis, photoperiod ranges from 11h 19'25" to 12h 9'26". Germination resulted to occur both in sunny and shaded areas, with light intensity ranging from 100 to 2000 PPFD and RED/FAR RED ratio ranging from 1(sun) to ~ 0.3 (shadow). Clouds effect was analysed in an open area showing a significant reduction of light intensity (up to 90 %) without great variations in light quality. In particular, RED/FAR RED ratio, very important for germination and first stages of seedling growth, remains invariable. Commercial plant lights provide spectra which are too different from that of the sun, especially for higher values of PAR and RED/FAR RED ratio. To evaluate the effect of different spectra on germination and seedling development, 7 light sources were tested for cork oak propagation with a photoperiod of 12L 12D. Data were compared to those collected into the forest. Germination and seedling development resulted to be speeded up under all artificial conditions. This may be caused by the lack of diurnal temperature variations and by the high PAR and RED/FAR RED ratio values of the lamps.

Keywords: Light needs, germination, cork oak, photoperiod.

INTRODUCTION

Forest restoration programs include the reintroduction of trees in degraded sites by means of two methodologies: 1) fostering the natural regeneration from mother plants; 2) supporting the regeneration, i.e. planting new seedlings produced in nurseries. Different natural factors affect plant growth, both in natural environment and in nurseries: light, nutrients, temperature, wind, soil moisture and composition, animal predation and species competition, the latter only related to natural environment. An innovative way to avoid or reduce some of these limiting factors is the application of the plant factory concept also into forest plant production. Plant factories are closed growing

systems producing high-quality vegetables during the whole year, due to an artificial control of the cultivation environment (i.e. light intensity, photoperiod, temperature, carbon dioxide concentration, relative air humidity, culture substrata). Thanks to the total independence from climate and multiple cultivation shelves, these systems lead to a faster and more plentiful production than traditional outdoor cultivations, also for exotic species. Another important advantage of such systems is that pesticides are not needed. These systems are energy saving technologies, able to reduce vehicles emissions thanks to the local production, as well as the consumption of soil and water, the latter also possible to be recycled. In Japan, about 200 plant factories are currently producing lettuce, herbs, tomatoes, strawberries and other agricultural species (Kim 2010, Lee 2010). Presently, no plant factories producing forest species are available. The first European project focusing on this topic is Zephyr (www.zephyr.project.eu). This project, started in 2012, aims to the introduction of an innovative technology inspired by the plant factory concept for the pre-cultivation of forest regeneration materials in a zero-impact and cost friendly mobile production unit. During a 3-years work, about 20 different forest species have been cultivated under artificial lights in order to define the optimal growth protocols for a mass production of seedlings into the final prototype. For each species the best values of temperature, relative air humidity and photoperiod have been defined according to data from literature and field surveys. While the optimal values of the abovementioned parameters for a target species are easily achievable, the definition of the best qualitative light conditions for its growth is a challenging hint. Indeed, forest species are divided into two main classes basing on their light needs: heliophilous species (or shade intolerant) and sciaphilous species (or shade tolerant). Generally, this classification is valid for adult trees, but sometimes the behavior of the seedlings is divergent from the mother plants (Loach 1970). To understand the real light needs of seedlings, field surveys are needed in forests where natural regeneration occurs. This study focuses on cork oak (*Quercus suber* L.), a Mediterranean evergreen oak growing up to 20 meters; an emblematic species of many landscapes of the Mediterranean Biome, sustaining rich biodiversity, ecological processes, ecosystem preservation and representing a valuable source of income from its bark, the cork. The ongoing repercussions of human impacts and climate change are still shaping the cork oak distribution, thus increasing the threats for the species permanence in many areas of the Mediterranean. In view of this, reforestation programs are becoming a primary need. Different studies are available on the effects of various degrees of shade on cork oak seedlings growth (Benayas 1998, Cardillo et al. 2006) but no attempts of cultivating this species under artificial lights have been made up to now. This study is the first focusing on the effectiveness to produce a great amount of cork oak seedlings, in a controlled environment, ready to be used in reforestation programs.

MATERIALS AND METHODS

Selection of light sources

Different spectra provided by commercially available lamps generally used in greenhouses to promote photosynthesis were compared. Each commercial lamp was

characterized by a specific wide continuous spectrum ranging from 180 to 1100 nm, almost lacking in UV and infrared and with different percentages of blue, green, yellow, orange and red wavelengths. Among these, FLUORA (Fluorescent lamp, Osram) and NS1 (LED lamp, Valoya) resulted to be the most resembling sunlight. Moreover, NS1 was preferred because of the lower energy consumption, the longer life, and the lower heat production of LED in comparison to fluorescent lights.

Study site

A natural cork oak forest located in the Natural Reserve of Tuscania (Viterbo, Central Italy, 42°25'08"N, 11°52'06"E, 189 m. a.s.l.), was chosen as study site (Figure 1). This forest, recognized as SCI (Site of Community Importance), occupies 40 ha of the total 1,901 ha of the Reserve, which is divided into two halves by the Marta River. Acorns production is abundant and natural regeneration as well, even if new seedlings have to face the high stress of Mediterranean summer drought, which is one of the main causes of seedlings' death during the first year of life (Pausas et al. 2009). Canopy cover is too dense, so that seedlings do not grow in open areas but in different degrees of shade.

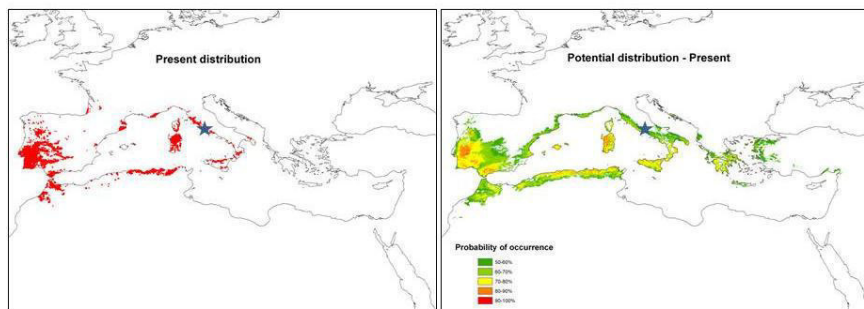

Figure 1. Present and potential distribution of cork oak

Collection of climatic parameters

Daily climatic parameters were downloaded from a meteorological website (www.ilmeteo.it) for the period from November 2014 (corresponding to acorns fall and beginning of germination) to May 2015 (corresponding to the first apical bud closing of new seedlings): Tmin and Tmax; humidity percentage; precipitation; photoperiod and irradiance.

Theoretical daily irradiance was calculated using the Solar radiation ARCGIS toolbox, under standard conditions of clear sky and considering topographical features as secondary variables. Photoperiod was calculated as day length between sunrise and sunset, using the exact times for sunrise and sunset, daily provided by the above-mentioned website.

Light analysis

Six areas with abundant cork oak regeneration were selected inside the forest, 3 of them well-lighted at noon (HL) and 3 shaded at noon (LL, 50-60% of full PAR). At the beginning of November 2014, 6 metal cages (50x50 cm) were placed, one per area, to

avoid animal predation of acorns. Light spectra (from 180 nm to 1100 nm) were hourly collected, from 9 am to 2 pm, in a sunny day to avoid possible interferences by clouds, per each cage. Two different spectra were collected as controls in an open area during a sunny and a cloudy day (control 1 and control 2, respectively). Light spectra collected at noon were subdivided into 8 regions, identified by specific ranges of wavelengths corresponding to a specific color: UV (ultraviolet) < 400 nm; blue-green (400-520 nm); yellow-orange (520-610 nm); red (610-720 nm); Far red (720-850 nm); IR (infrared) > 850 nm. A quantitative comparison of irradiance (W/m^2) of single regions was carried on among the 6 cages and controls.

Seedlings analysis

Dates of germination, shoot apex emergence and first bud closing, as well as the percentages of germination and of emergence, during a period ranging from January (early emergence) and May (late emergence), were detected for each cage. Moreover, after the first leaves sprouting, shoot height and number of leaves were monthly measured until the first apical bud closing. At apical bud closing stage, thinness coefficient was evaluated, as ratio between shoot height and shoot diameter.

Indoor growth

Growth protocols

Acorns were collected in the cork oak forest of Tuscania at the beginning of November 2014 and stored at 4°C in a dark aerated box until February 2015. At the beginning of February, they were immersed for 24 hours in tap water in order to rehydrate them and to select the ones eligible for sowing. Then, 52 acorns with pericarp and 52 deprived of pericarp, were disinfected with a solution of 20% sodium hypochloride and sown into a multi-plug tray (Herkuplast, QPD104VW, 104 pots) using a peat-based substrate. The tray was incubated into a phytoclimatic chamber under NS1 light. Light intensity, air temperature and relative air humidity were kept constant, respectively at 150 ± 50 PAR, $22 \pm 2^\circ C$ and $50 \pm 10\%$. A 12L 12D photoperiod was applied.

Seedlings analysis

Seedlings growth was weekly monitored measuring shoot height and number of leaves. The percentage of germination and the date of germination, shoot apex emergence and first bud closing were detected. At apical bud closing stage, thinness coefficient was calculated.

RESULTS

Study site

Collection of climatic parameters

Table 1 shows minimum, maximum and mean value of daily Tmin, Tmax, precipitation, humidity and irradiance for the study site, between November 2014 and May 2015.

Table 1. Climatic parameters referred to the study site of Tuscania (Nov 2014-May 2015)

Parameter	Minimum value	Maximum value	Mean value
Daily Tmin	-2°C	+16°C	6.1°C
Daily Tmax	0°C	25°C	13.9°C
Daily precipitation (Total precipitation Nov 2014-May 2015: 941 mm)	0 mm	72 mm	5.19 mm
Daily humidity	37%	97%	75%
Daily irradiance	726.39 kWh/m ²	5,562.48 kWh/m ²	2,381.83 kWh/m ²

Figure 2a shows the annual photoperiod for different latitudes into the range of cork oak. Figure 2b highlights the annual curve referred to Tuscania. Figure 2c shows the photoperiod referred to Tuscania, in the period of analysis (Oct 2014-May 2015).

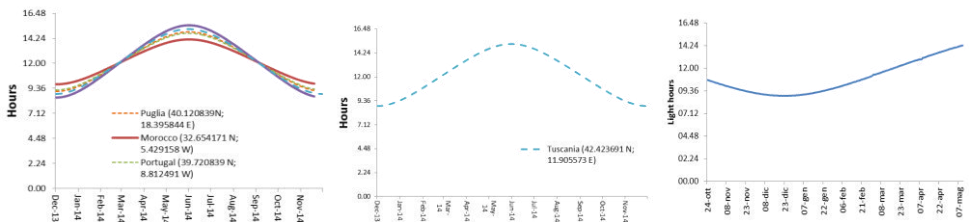

Figure 2. a) annual photoperiod for different latitudes into the range of cork oak; b) annual photoperiod for Tuscania; c) Photoperiod for Tuscania (Oct 2014- May 2015).

Light analysis

Spectra collected for each cage from 9 am to 2 pm in a sunny day, showed as no cage has been constantly exposed to the same level of light during the day, rather to different degrees of partial shade, whose depth depends on the canopy density (Figure 3). Spectra collected at noon were quantitatively and qualitatively compared to control 1 and 2 (Figure 4) as shown in table 2.

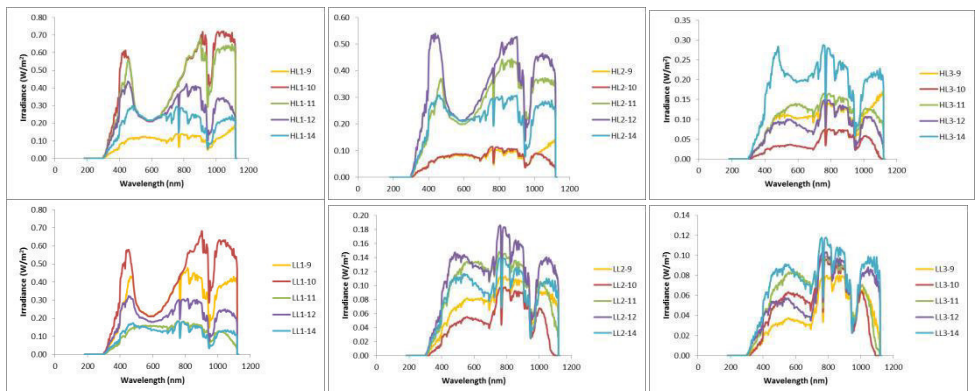

Fig.3. Spectra collected from 9 am to 2 pm in correspondence of high light cages (HL1-HL2-HL3) and low light cages (LL1-LL2-LL3)

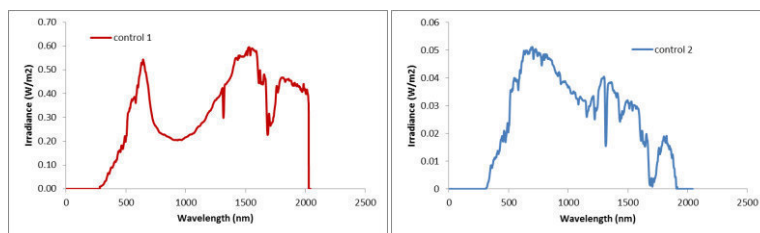

Figure 4. Control spectra collected at noon in a sunny day (control 1) and in a cloudy day (control 2)

Table 2. Comparison of the irradiance of the different colour regions of the spectra collected at noon in correspondence of each cage, expressed as W/m^2 and percentage of total irradiance.

	HL1	HL2	HL3	LL1	LL2	LL3	control 1	control 2
UV	27.16 (2.5 %)	37.14 (3.49%)	19.41 (2.38%)	5.67 (1.09%)	7.75 (1.24%)	3.79 (0.78%)	54.55 (5.28%)	0.77 (0.46%)
Blue-Green	95.63 (8.82%)	117.27 (11.03%)	73.39 (9.01%)	22.48 (4.32%)	33.98 (5.42%)	13.21 (2.74%)	133.64 (12.93%)	3.18 (1.91%)
Yellow-Orange	43.97 (4.06%)	44.12 (4.15%)	37.51 (4.60%)	18.45 (3.55%)	26.67 (4.25%)	10.47 (2.17%)	44.12 (4.27%)	2.11 (1.27%)
Red	58.24 (5.37%)	62.92 (5.92%)	48.00 (5.89%)	18.00 (3.46%)	29.04 (4.63%)	10.20 (2.11%)	63.55 (6.15%)	3.04 (1.83%)
Far Red	98.31 (9.07%)	116.38 (10.94%)	75.79 (9.30%)	34.48 (6.63%)	43.22 (6.89%)	23.77 (4.93%)	129.61 (12.54%)	4.37 (2.63%)
Infrared	273.71 (25.26%)	350.98 (33%)	204.43 (25.08%)	86.59 (16.65%)	113.96 (18.17%)	65.49 (13.57%)	472.45 (45.71%)	11.28 (6.79%)
Tot (180-1000 nm)	1083.73	1063.64	814.98	520.13	627.26	482.71	1033.64	166.11

Seedlings analysis

No significant differences among cages were found in terms of phenological stages. Germination of acorns started in November 2014. Shoot apex emergence of seedlings was detected in the first half of January 2015, after winter solstice and first winter frosts. First apical bud closing started in the first half of May 2015, as shown in Figure 5. Well-light cages (HL) and low-light cages (LL) were compared in terms of germination, early and late emergence percentages. For all the parameters HL cages showed higher results, mainly for germination and late emergence (Figure 6). Seedlings growing into HL and LL cages, showed no significant differences in terms of shoot height but a higher number of leaves was found in HL seedlings (Figure 7).

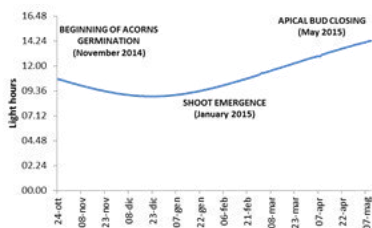

Figure 5. Phenological stages detected into the forest

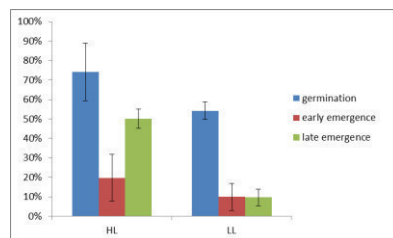

Figure 6. Germination and shoot emergence in HL and LL

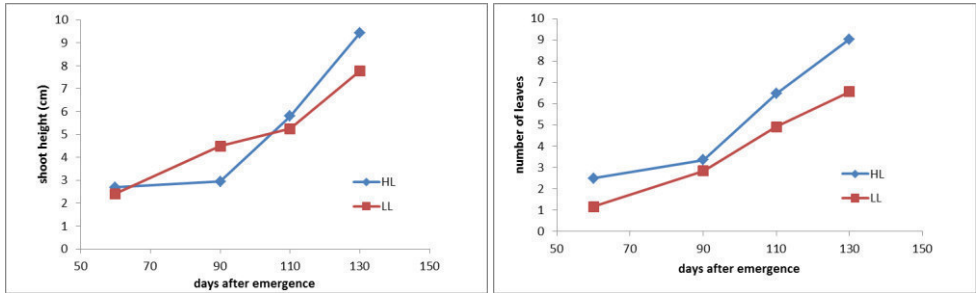

Figure 7. Shoot height and number of leaves of seedlings in HL and LL cages

Comparison between seedlings growth indoor and in the forest

Germination under NS1 light started only 24 hours after sowing and lasted for 1 week. Acorns without pericarp showed a higher germination rate if compared to those with pericarp (Figure 8). Emergence started after ~10 days since the germination, while first apical bud closing occurred after 70 days. A second growth phase started after 100 days and lasted only 20 days. A second brief stop in active growth occurred therefore between 120 and 125 days since the germination, followed by a third growth phase. Conversely, the emergence in the field started after 90 days from the germination and the active growth continues for 180 days after the germination, at the beginning of May 2015 (Figure 9). In terms of growth performance, acorns with pericarp became seedlings characterized by higher values of shoot height and number of leaves (Figure 10).

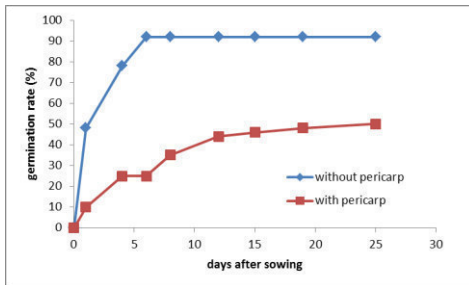

Figure 8. Germination of acorns with and without pericarp

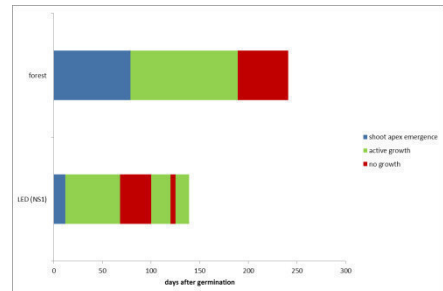

Figure 9. Phenology comparison between forest and growth chamber

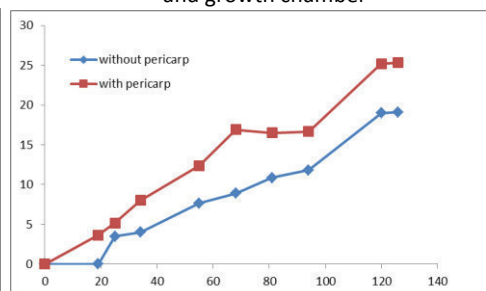
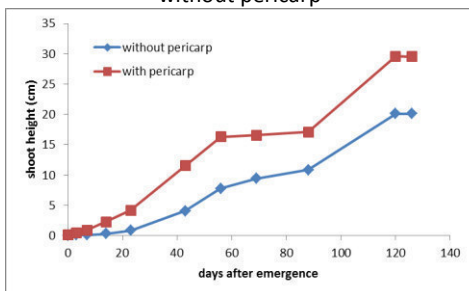

Figure 10. Shoot height and number of leaves of seedlings deriving from acorns with and without pericarp

A comparison between artificially and naturally grown seedlings in correspondence of their first apical bud closing (respectively 60 and 120 days after the emergence), showed a significant difference in terms of morphological parameters. In particular, seedlings deriving from acorns deprived of pericarp, showed similar values of shoot height, number of leaves, diameter and thinness coefficient to those grown in nature. On the other side, seedlings from acorns with pericarp showed almost double values for each parameter (Table 3).

Table 3. Comparison of shoot height, shoot diameter, number of leaves and thinness coefficient (height/diameter ratio) between seedlings grown indoor and in the forest at first apical bud closing.

	shoot height (cm)	diameter (cm)	number of leaves	thinness coefficient
without pericarp NS1	9.1	1.46	8.8	6.23
with pericarp NS1	18.1	2.25	16.9	8.04
forest	9.66	1.54	9.14	6.27

The comparison of seedlings growth in terms of days after the emergence showed a large difference both in shoot height and in number of leaves between seedlings naturally and artificially growing (Figure 11). When first apical bud closing occurred in forest (120 days after the emergence, red circles in Figure 11) seedlings under LEDs were at the beginning of their second growth phase and both shoot height and number of leaves showed double values when compared to those growing into the forest.

Moreover, at the first apical bud closing under LEDs (60 days after the emergence, blue circles in Figure 11), seedlings growing into the forest showed a very slow growth rate. An increase was noticeable only after 90 days from the emergence (April 2015).

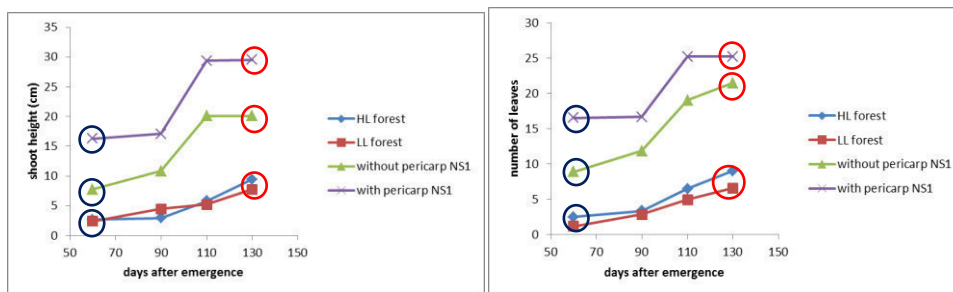

Figure 11. Comparison in terms of shoot height and number of leaves between seedlings grown in the forest (in HL and LL cages) and under NS1 light from acorns with and without pericarp.

DISCUSSION

Cork oak seedlings, growing under full sun (HL) and 50-60% of full PAR (LL) into a natural forest, showed higher germination and emergence percentages under HL conditions. Since these first stages are not directly linked to the photosynthetic activity,

the higher results could rely on a thermal effect due to the IR region of sunlight spectrum. In the following stage of active growth, seedlings showed no significant differences among HL and LL areas, in terms of shoot height but a higher number of leaves was found in HL seedlings. According to some previous studies carried on in nurseries to analyze the shade tolerance of cork oak, it was assessed as seedlings are able to grow without any negative effects up to 2-5% of full PAR (Aranda et al. 2005, Pardos et al. 2005). Under this limit, plants start to suffer showing clear symptoms of etiolation and a drastic reduction of net assimilation rate which can also reach zero value (Cardillo and Bernal 2006). Seedlings growth rhythms in HL and in LL conditions resulted to be phenologically synchronized. The acorns germination occurred at the beginning of November, under mild temperatures and high humidity, followed by a period of growth break due to winter frosts. After the first days of January 2015, in which acorns were still exposed to negative T_{min}, milder temperatures and the increasing photoperiod favoured seedlings shoot apex emergence. Seedlings growth rate was very slow up to the spring equinox, when a sudden increase was observed. The average monthly percentage of sunny days between January and March was only of ~25%, while that of cloudy days ~45% and that of rainy days ~30%, thus a possible role of clouds on limiting seedlings growth has to be considered. Clouds are in fact able to reduce sunlight intensity up to 90% (in rainy days with high cloudiness), affecting the whole spectrum, similarly to deep shadow induced by canopy cover, reducing the amount of wavelengths driving photosynthesis and thermal radiation. First apical bud closing occurred into the forest at the beginning of May, when climate became hotter and drier. Under artificial lights, the time between germination and shoot apex emergence was reduced up to 84%, and up to 50% between emergence and first apical bud closing. Moreover, thanks to a higher growth rate, artificially grown seedlings showed double values for shoot height, shoot diameter and number of leaves, compared to those grown into the forest at apical bud closing.

CONCLUSIONS

Artificial lights resulted to be an innovative solution to obtain a high amount of seedlings in a very short time and to increase the standard growth rate of cork oak seedlings into a forest or into a traditional nursery, due to the absence of climatic stresses linked to eventual variations in temperature or humidity which generally stop seedlings growth. The possible growth of seedlings both in high and low light conditions assessed in the forest allows using low PAR values in artificial growth chamber, with a relevant energy-saving effect.

REFERENCES

- Aranda I., Castro L., Pardos M., Gil L., Pardos J.A. (2005). Effects of the interaction between drought and shade on water relations, gas exchange and morphological traits in cork oak (*Quercus suber* L.) seedlings. *Forest ecology and management*. 21(1-3):117-129.
- Benayas J.M.R. (1998). Growth and survival in *Quercus ilex* L. seedlings after irrigation and artificial shading on Mediterranean set-aside agricultural land. *Ann. For. Sci.* 55(7):801-807.

- Cardillo E., Bernal C.J. (2006). Morphological response and growth of cork oak (*Quercus suber* L.) seedlings at different shade levels. *Forest Ecology and Management*. 222(1-3):296-301.
- Kim J.W. (2010). Trend and direction for plant factory system. *J. Plant. Biotechnol.* 37(4):442-455.
- Lee S. W. (2010). Plant Factory and plant cultivation using the LED artificial light. *Optical science and technology*. 14(3): 12-19.
- Loach K. (1970). Shade tolerance in tree seedlings. *New Phytologist*. 69(2):273-286.
- Pardos M., Jiménez M.D., Aranda I., Pardos J.A. (2005). Water relations of cork oak (*Quercus suber* L.) seedlings in response to shading and moderate drought. *Ann.For.Sci.* 62: 377-384.
- Pausas J.G., Marañón T., Caldeira M. and Pons J. (2009). Chapter 10: Natural regeneration in: Aronson et al. (2009) *Cork oak woodlands on the Edge*. Island Press.

AERIAL REFORESTATION BY SEED BOMBS

Ortolani Maria Raffaella, Schirone Avra, Camillotti Gabriele, Schirone Bartolomeo

*Corresponding author: raffaellaortolani@libero.it

Ortolani M.R., Schirone A., Camillotti G., Schirone B. (2015). Aerial reforestation by seed bombs. In: Ivetić V., Stanković D. (eds.) Proceedings: International conference Reforestation Challenges. 03-06 June 2015, Belgrade, Serbia. Reforesta. pp. 227-233.

Abstract: Planting seedlings is the most used technique for reforestation used today as it has the highest guarantee of success. There are, however, some cases that direct sowing is preferable whether for economic or technical reasons. On the other hand, there may be conditions of urgency or difficult access to a given site where sowing cannot be carried out according to traditional techniques. These situations make area sowing a valid alternative. We give here the first results obtained from the use of 'seed bombs' for forest 'nucleation' intervention.

The study conducted in collaboration with the Italian National Forest Service, is developed along two lines of research:

- aerial means and flight conditions more suitable for aerial sowing and
- seed bomb preparation.

Studies regarding airplanes, helicopters, and drones gave results relative to which type of helicopter is better suited, the ideal flight altitude and speed for seed bomb throwing and the potentiality of drones. Studies made on the planning of a new type of seed bomb have brought about the realization of a biodegradable covering that contains a mix of seeds, dirt and other components.

The results of the first attempts of seed bomb throwing are given here including seed engraftment and germination. In the light of experiments conducted so far, aerial seeding seems to be interesting as a new instrument to be used along with traditional techniques in reforestation planning.

Key words: aerial seeding, seed bombs, reforestation.

INTRODUCTION

The progressive degradation of the terrestrial forest ecosystems is producing irreparable damage and loss of biodiversity. The effects of this for humanity are not yet measurable but can be estimated to be catastrophic.

Therefore, reforestation operations are fundamental for the recovery of the degraded territories. However, the terrains that are dramatically steep make normal reforestation operations impossible, it is therefore necessary to adopt adequate seeding techniques. Seedling planting is the most used reforestation technique today because it offers the highest probability of success. There are, however, some cases where direct seeding is preferable for economical reasons.

On the other hand, in some conditions of urgency or difficult access to the site for intervention, seeding cannot be done according to traditional methods, and in these cases aerial or aero-hydroseeding are valid alternatives. A good example in this sense was realized by the LEADER projects, with the Parco Nazionale del Cilento (the national park of Cilento) in Salerno, Italy. The project planned for restoring coastal Mediterranean forest areas devastated by fires with hydro-seeding operations. The techniques used were based on reconstituting the associations naturally present with native material, allowing for the restoration of the natural succession of space in a relatively short time. One of the most remarkable aspects of the operations was the use of tree species seeds (*Pinus halepensis* Mill.) keeping into account that the traditional techniques of hydro-seeding generally use exclusively grass species seeds. Hydro-seeding was conducted by sprinkling from a high altitude (by a helicopter bucket) that favoured the randomness of coverage of the particularly steep and difficult territory. It is to be noted that this type of procedure was definitely advantageous in terms of cost (about 50%) compared to the entire cost of traditional reforestation (Leone 2001).

However, difficult or extended areas cannot be covered entirely. This is why reforestation in core units has been done for some time. Once these are affirmed, reforestation in the remaining space will come about spontaneously from the core units introduced, or will be done by human intervention starting from the same.

To this end, the department of Science and Technology for Agriculture, Forestry, Nature and Energy (DAFNE) of the University of Tuscia, with the support of the Italian National Forest Service (Corpo Forestale dello Stato), has realized clay shells appropriately modelled so to be thrown by helicopters. These shells contain a mix of biodegradable materials, suggesting a variation of the more traditional protocol of seed bombs known also as seedballs.

Seed balls are a conglomeration of clay, sifted dirt and seeds (mostly the grass family), mixed with water. The same were already used in ancient Egypt to replenish the banks of the Nile after flooding, and were then used in Asia, mostly in arid areas due to their capacity to protect the seeds from birds and rodents. Having already obtained excellent results, this technique was considered for application in forestry. The preparation of the seed bombs was adapted for use in reforestation, more than grass seeding, taking into account the considerable variability in the dimension of tree seeds. This did not only concern the proportions of the different components but most importantly the size of the clay covering of the actual ball. The Italian National Forest Service had to intervene at the time of seeding with their most suitable vehicle: the helicopter is the only mean for carrying out this type of operation and seems to be the prompt solution to avoid soil erosion by ensuring successful reforestation of degraded areas, destroyed by fire or that are very steep.

MATERIAL AND METHODS

Seed bombs are made of a clay shell that contains a mixture that represents the core unit for reforestation. The composition is based on the use of materials that are naturally present, and therefore it is a reforestation method that totally respects the

environment.

The preparation begins by making the external shell, modelled with clay in pieces of cloth on a plastic mold. This mold is sprayed with vaseline oil to make extraction easier after drying. Once the shells are ready, they are filled with the mixture of seeds, compost, sand, carbon and a hydro retention gel.

In recent times, the use of hydro retention gels was introduced in reforestation activities in order to obtain better planation results. It acts as a sort of glue that prevents the contents of the seed bombs from sliding down to the valley, especially when used on steep slopes. It also keeps the internal mixture from dispersing excessively. Instead, the hydrated gel provides water and maintains the correct level of hydration of the seeds necessary for germination. Considering the objective of the seed bombs, it is obvious that a repellent must be used to keep away small animals and insects to protect the seed. Clay powder mixed with water is used to seal the two halves of the shell once filled.

Once prepared, it is advisable that the shells are refrigerator stored at 4°C. In fact, comparing the loss of weight of shells kept at room temperature and those stored at 4°C (Graph 1), there is more loss in the first. The loss is probably due to the dehydration of the internal materials of the seed bombs. Therefore, in order to protect the level of moisture, which is necessary for seed germination, it is preferable to refrigerator store the shells at 4°C.



Figure 1. Agusta-Bell 412.

Two trial runs were conducted to experiment the effectiveness of the seed bombs. The first experiment was to test the mechanical aspect of the seed bomb, which is to observe how it breaks when thrown from a helicopter at different altitudes. The second experiment was to observe the reaction of the seeds within the seed bombs.

Different models of helicopters were tested for the aerial seeding and the best resulted the Agusta-Bell 412 (Figure 1). So, this machine was used to conduct the trial runs, piloted by the Centro Operativo Aereo del Corpo Forestale dello Stato Italiano (the air operations center for the Italian National Forest Service) the branch in the city of Rome.

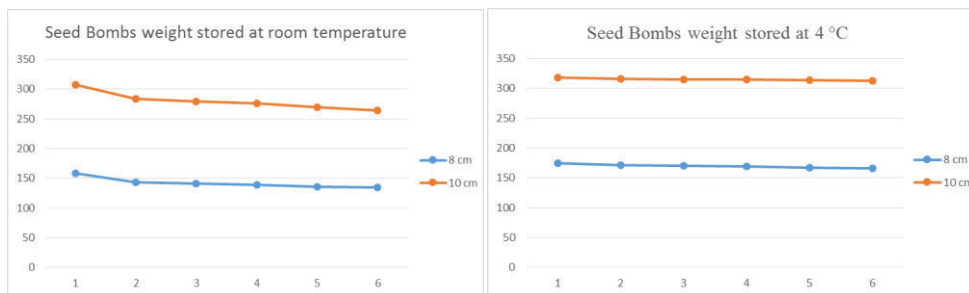

Graph 1. Moisture loss in seed bombs stored at room temperature and refrigerated at 4°C.



Figure 2. Seed bomb throwing.

First trial run

The first experiment was done within the grounds of the airport of the Italian National Forest Service in Rome. The aim of this operation was to observe the reaction of the *seed bombs* on impact with the ground, according to form and altitude. Therefore, external shells were made in two different shapes: spherical and ogival. Once these were dried out, the shells were filled with dirt and sand so that their weight was the same as the *seed bombs* filled with the mixture made by DAFNE. The reason for this, as mentioned before, was to observe the dynamics of impact and choose the best form. The throw was carried out at different altitudes: 50 m, 100 m and 150 m.

Second trial run

The second experiment was done within the forest nursery "Nello Lupori" of the University of Tuscia. As already mentioned, the purpose was to observe what happens to the seeds contained in the *seed bombs* once they touch the ground. For this purpose, were used the mixture made by DAFNE with *Lens culinaris* (Medik) seeds. The objective was to observe the degree of germination and the percentage of rooting after impact. Lentils were chosen because they are quick to grow.

RESULTS AND DISCUSSION

The result of the first experiment was that there was no difference generated by the shape: both the spherical and ogival seed bombs hit the ground with the same trajectory and reacted to the impact in the same way (Figure 3). Given that the spherical shape is easier to make, the ogival shape was excluded as a result.

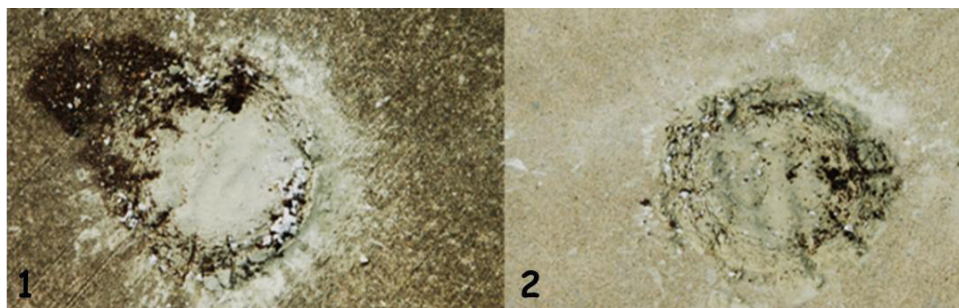
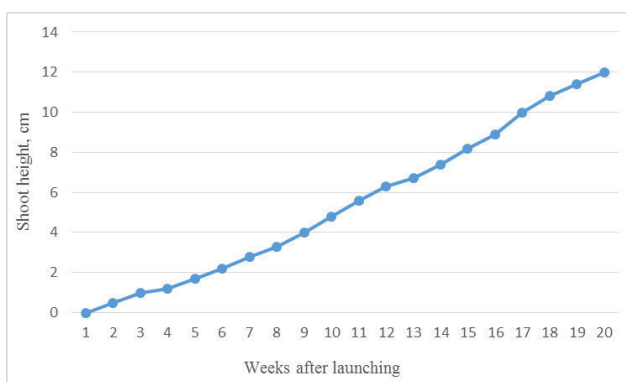

Figure 3. Spherical seed bombs (1) and ogival ones (2) after impact.

Data were gathered from the experiment to observe the effects of different altitudes. As mentioned before, helicopters flying in hovering (altitude steady and zero speed) at different altitudes so as to determine the ideal altitude from which seed bombs should be thrown (50 m, 100 m and 150 m). The different altitudes made no changes in the type of impact on the ground by the seed bombs.

Regarding the reaction of the seed contained in the seed bombs, experiments gave satisfactory results. Considering that non-selected *Lens culinaris* (Medik) seeds were used, there was an excellent level of germination (85%). Moreover, plants that were about 1 cm high were already visible after 10 days. After 5 months from the throw, the plants were about 12 cm high (Graph 2; Figure 4).



Graph 2. Height of the *Lens culinaris* (Medik) plants during the period of the experiment.



Figure 4. *Lens culinaris* (Medik) plants 5 months after the throw.

The experiments were carried out in autumn which is the ideal season for reforestation, especially in the Mediterranean area, because temperatures are still mild and precipitation is sufficient enough for keeping the ground constantly moist. However, the time the seed bombs will be thrown is after an episode of abundant rain.

The experiments showed that the mixture within the seed bombs was effective for the protection of the plant rootlets. In fact, the seeds that were in contact with the mixture did not show any symptoms of damage, differently from those that had no contact (even though already germinated) that showed signs of burning at the tips of the roots (Figure 5).



Figure 5. Detail of the *Lens culinaris* (Medik) seeds not in contact with the mixture within the seed bombs.

CONCLUSION

The two experiments conducted were necessary to comprehend two fundamental points of the research. Above all, it was found that altitude had no effect on shell breakage. However, it can be affirmed by hypothesis that altitude should be established for each case according to the type of helicopter used, to the obstacles on the

ground and the relative morphology of the area to be intervened upon.

The first experiment made it obvious that hand throwing is not easily done, so the use of a small instrument (to be loaded on board the helicopter), in the shape of the cockpit or cabin of the aircraft to be used is preferable.

Although the experimental phase is still in progress, the forestry seed bombs of the DAFNE department have given encouraging results. Nevertheless, further studies are necessary to verify effectiveness. The first experiments involve the analysis and the study of the aerial means to throw the seed bombs and the study of the stowage of materials during reforestation procedures. Research is also addressed towards mechanical engineering aspects, such as throw planning and machines for seed bombs construction. Finally, further aspects to be analyzed concern the study of the treatment and preparation of the seeds to be used and the analysis of the mixture within the *seed bombs*.

Experiments are currently being done where throws use *Pinus sylvestris* L. seeds, *Quercus ilex* L., *Quercus suber* L. and *Myrtus communis* L. (Figure 6) with positive results considering the number of seeds germinated so far. Moreover, the positive reaction obtained by the lentil seeds gives good reason to expect no problems when using seeds of forest species.



Figure 6. Seedlings of *Pinus sylvestris* L., *Quercus suber* L. and *Myrtus communis* L. within the seed bombs.

REFERENCES

- Calvo E. (2007). La vivaistica per un migliore futuro del nostro ambiente. Ersaf Lombardia. Alberi e Territorio n.12.
- Corrado G. (2007). Lezioni di selvicoltura e di gestione del bosco; p. 64, 65.
- Gisotti G. (2012). Il dissesto idrogeologico. Previsione, prevenzione e mitigazione del rischio. Dario Flaccovio Editore.
- Leone V. (2001). Interventi selvicolturali per il recupero di soprassuoli boschivi percorsi da incendi. Italia forestale e montana n. 6.

COSTS AND REVENUES IN POPLAR PLANTATIONS ESTABLISHED USING FULL GROUND AND SOIL PREPARATION IN SERBIA

Keča Ljiljana, Pajić Sanja

*Corresponding author: ljiljana.keca@sfb.bg.ac.rs

Keča Lj., Pajić S. (2015). Costs and revenues in poplar plantations established using full ground and soil preparation in Serbia. In: Ivetić V., Stanković D. (eds.) Proceedings: International conference Reforestation Challenges. 03-06 June 2015, Belgrade, Serbia. Reforesta. pp. 234-241.

Abstract: Poplars belong to the most productive tree species in Serbia. Production complexity of poplar wood requires rational and well-planned management. Conventional poplar growing in Serbia is characterized by high costs of plantation establishment, as it is common to use the technology of full ground and soil preparation with a lot of working operations, which are analysed in the article. Costs can be reduced by finding out the solution in the field of soil preparation for afforestation and choice of working operations which show a higher level of economic efficiency in the future. It will influence to cost-revenue ratio of poplar cultivation and possibly also the price of the product, *i.e.* logs for further wood processing.

Costs and revenues in poplar plantations are presented using the analysis of their dynamics in selected forest compartments of Ravni Srem (Forest Estate „Sremska Mitrovica“, P.E. “Vojvodinašume”, Republic of Serbia). The stands which are analysed are grown on different soil types and are of different age, while their initial planting density is the same 6 × 6 m. Also revenues from the analysed compartments are presented. The results obtained in this way don't have just a commercial importance, but also some social relevance. The social interests can be: increase in forest cover, ecological benefits, stable and safe market supply with wood raw material, etc. In practice, it is necessary to improve the position of wood producers in getting deficient financial means for the investment in poplar cultivation, so as to stimulate the establishment of poplar plantations, especially in the private sector, on lands which are not attractive for agriculture production.

Key words: poplar plantations, cost-efficiency, revenues, market.

INTRODUCTION

Plantation production is such a form of timber production, which is based on the cultivation of species of rapid growth in a short production cycle with the use of intensive agro-technical, agro economic and silvicultural measures. The main task of this production is to provide high yields (per unit area) of certain assortments and low production costs. As the plantations of poplars are very similar to certain agricultural cultures and in during its utilization plantations follow agrotechnical, technological and economic basis (Sredojević 1998). The economic basis stems from the technological and technical bases of

agricultural practices and essentially includes: costs or cost price (timber, etc.) and investments per unit of capacity. Cost, revenue and profit are the three most important factors in determining the success of management in poplar plantations. A business can have high revenue, but if the costs are higher, it will show no profit and is destined to go out of business when available capital runs out. Managing costs and revenue to maximize profit is key for any production.

The goal of the article is to research costs and revenues of 4 study plots in poplar plantations in Ravni Srem and to point out the cost effectiveness using full ground and soil preparation in them.

MATERIALS AND METHODS

The investigated sample plots were established from *Populus x euramericana* cl. I-214, with planting spacing 6 x 3 m (555 trees per ha), for technical wood production, in the Northern province of Vojvodina. There were investigated 4 study plots, aged 24-42 years, with a total area of 45.35 ha (Table 1). Soil type in the plots is alluvial semigley. The research was carried out in plantations of poplar, in the area of the river Sava, in the period 2002 – 2013. Data pertaining to costs during years 0-5 (soil preparation, planting, care and protection, etc.) (Table 2) were obtained from the archives of the forest enterprise which managed the studied plantations, and also the data from material books (Keča and Pajić 2010). Since all studied stands are state-owned and managed by the Public Forest Enterprise “Vojvodinašume”, the value (cost) of the land (land rent) did not enter into the calculations (Keča et al. 2011). All income at the end of analysed rotation (24, 26, 37, 42 years) is presented through: the value of F-veneer and L-peeling logs, timber wood class I and II, and pulpwood and income from schematic thinning.

Investment Appraisal is part of capital budgeting (Campbell and Brown 2003) and it is applicable to areas even where the returns may not be easily quantifiable (Keča 2010a, 2010b, Keča 2011a, 2011b), such as investment appraisal in forestry.

RESULTS AND DISCUSSION

Forest Management Plans prescribe rotation period in plantations of poplar on 25 years, and thus a certain time major harvest - the main income in the cultures of clone poplars. Major cuts in plantations of clone poplars belong to the group of clean felling i.e. removing all trees from the selected area. Marking of trees for cutting in restoration is carried out along the border line that is included in the area of clean cut. Harvesting is realized at a time when there is no risk of sudden arrival of high water, to effectively protect produced assortments during floods. When performing cuts must be taken into account that felled trees not intersect and the stump height does not exceed $\frac{1}{4}$ of diameter. Cutting of felled timber is adapted to market conditions, to achieve maximum financial effects (greater participation of technical wood in relation to the physical, waste is minimized) and performed by a qualified person.

Harvesting is carried out with chainsaws, but lately uses the harvester. Organizational form of workers consists of two loggers and a chainsaw. The distance

between the parties is twice the height of mean stand tree. Bringing out of assortments is done by forest roads, in the shortest possible time, to forest stock where wood material is housed in an accessible place and safe from flooding.

Structure of costs of major felling in cultures of clone poplars in Ravni Srem is composed of two segments of direct costs. These are: costs of felling and work up and the second are costs of extracted assortments. The costs of felling and work up are related to chainsaw (consumption of fuel, motor oil, chain oil, cutting sets, etc.) and labor force (direct labor costs of loggers, etc.). The second segment consists of the costs of extraction of produced assortments.

Table 1. Structure of costs in major felling in sample plots.

Study plot	Type of Forest	Age	Area	Harvested wood			Costs of felling and work up			Costs of extraction of assortments		Compensation for felled wood	The cost of the drive overheads	Total costs of major felling	
				Timber	Cordwood	Σ	Fuel and lubricants	Amortization of chainsaws	Consumption of spare	Costs of labor	Mechanized works				Labor force
Unit of measure		year	ha	m ³			€								
1	IV/13	26	7.93	2139.6	727.81	2867.36	100.47	42.39	38.85	1330.99	1822.21	158.53	364.33	2195.78	6053.55
2	IV/18	24	25.00	6713.5	1529.99	8243.53	88.71	35.80	32.82	829.67	1614.92	97.18	332.65	1483.05	4514.80
3	IV/13	37	5.80	2845.1	426.79	3271.87	147.72	57.30	52.54	1733.99	2791.95	19.68	710.30	3087.57	8601.04
4	IV/13	42	6.62	2207.8	351.84	2559.68	101.61	39.62	36.32	1114.64	1872.33	59.74	503.38	1994.78	5722.43

Technical wood is exported to the forest road mechanized (expenses of machine forwarder), while the meter cellulose carries the costs of loading, unloading and stacking (expenses machines - tractors and manpower - loader). In addition to these direct costs in the cost structure come overhead expenses, personal incomes of professional staff (forestry engineers and technicians) that are directly related to the activity of forests utilization.

It can be concluded that the costs are present in the first six years of establishment of plantation. The main aim is to form the plantation as well as to decrease: annual costs for use and maintenance of plantation (1-5 years), annual incomes from plantation (schematic thinning in 6th year, income from non-wood products, technical logs of second class and cellulose wood), to pure annual benefits from invested object at the end of rotation, to capital costs (amortization, interest rates, etc.), to investment profit (Keča and Pajić 2010). Preparation of the ground and soil for afforestation is the most expensive operation in this production cycle (Keča and Keča 2014) (Table 2).

PROCEEDINGS
International Conference **REFORESTATION CHALLENGES**
03-06 June 2015, Belgrade, Serbia

Table 2. Annual costs of poplar plantation establishment for the rotation period of 24 years on 1 ha study plot 2.

Total in zero year	euro/ha	Total in the fourth year - Tending:	96.90
Ground preparation for afforestation	1195.17	Inter-row treatment	14.76
Mulching of waste wood	445.21	Inter-row treatment	21.54
Chipping of stumps M.L. 250 trees/ha, d=51-60 cm	454.01	Weed control between rows	41.80
Chipping of stumps of other species 400 trees/ha	215.11	Pruning	18.80
Collecting and removal of roots	80.85	Total in the fifth year - Tending:	96.90
Ground preparation for afforestation	300.0	Inter-row treatment	14.76
Ploughing	219.59	Inter-row treatment	21.54
I undermining of ground	48.01	Weed control between rows	41.80
II undermining of ground	32.40	Pruning	18.80
Afforestation with rooted cuttings of clone poplars spacing 5x5m (production, dividing, boring the holes, transport of rooted cuttings, planting of rooted cuttings)	545.31	Total in the sixth year	423.42
Total in the first year	209.44	Maintenance of plantation:	18.80
Maintenance and protection of plantation	209.44	Pruning	18.80
Inter-row treatment	29.41	Tree marking for schematic thinning	7.80
Inter-row treatment	43.07	Schematic thinning (6th – 12th year) :	415.62
Weed control between rows	42.08	Roundwood of small dimensions	Income
Digging up the rooted cuttings	48.70	Pulpwood	Income
Pruning	9.22	Compensation for cut wood 3% of market value.	31.93
Sprout removal	8.36	Cutting and processing	170.72
Disease protection	11.70	Extraction	212.97
Protection against insects	16.80	Total in the last (24th) year	5529.62
Total in the second year	207.48	Total survey for the main cutting	16.14
Afforestation with rooted cuttings of poplar clone, spacing 5x5m (production, dividing, boring the holes, transport of rooted cuttings, planting of rooted cuttings)	51.06	Mulching between the rows of poplar	
Maintenance and protection of plantation	156.42	Main cutting – main income	
Inter-row treatment	29.41	Assortment structure:	
Inter-row treatment	43.07	F class	
Weed control between rows	42.08	L class	
Digging up the rooted cuttings	9.22	I class	
Sprout removal	4.04	II class	
disease protection	11.70	Pulpwood	
Protection against insects	16.80	Compensation for cut wood 3% of market value	332.65
Total in the third year - Tending	111.65	Cutting and processing	1991.5
Inter-row treatment	29.51	Dragging	2811.6
Inter-row treatment	21.54		
Weeds control between rows	41.80		
Pruning	18.80		

Source: Keča Lj., Pajić S., 2010; Keča, Lj., Keča N., 2014, Special plan for researched and authors' calculations, original

PROCEEDINGS
International Conference **REFORESTATION CHALLENGES**
03-06 June 2015, Belgrade, Serbia

Revenues are present during the schematic thinning and at the end of the rotation in 4 sample plots. The highest revenue is in the sample plot 3 (24 years stand, alluvial semigley).

Table 3. Structure of revenues in major felling in sample plots.

Sample plot 1				
Assortment structure	Quantity		Price	Value of assortments by price list of PE
	m ³	m ³ /ha	€/m ³	€/ha
F	470.72	59.36	55.00	3264.77
L	425.72	53.68	45.00	2415.81
I	612.91	77.29	35.00	2705.15
II	630.20	79.47	27.50	2185.44
p.w.v.m'	400.21	50.47	17.14	865.02
p.w.m'	327.60	41.31	17.14	708.08
Σ	2867.36	361.58		12144.26
Sample plot 2				
Assortment structure	Quantity		Price	Value of assortments by price list of PE
	m ³	m ³ /ha	€/m ³	€/ha
F	984.76	39.39	55.00	2166.47
L	1207.95	48.32	45.00	2174.31
I	2419.03	96.76	35.00	3386.64
II	2101.80	84.07	27.50	2311.98
p.w.v.m'	896.88	35.88	17.14	614.90
p.w.m'	633.11	25.32	17.14	434.06
Σ	8243.53	329.74		11088.37
Sample plot 3				
Assortment structure	Quantity		Price	Value of assortments by price list of PE
	m ³	m ³ /ha	€/m ³	€/ha
F	1329.91	229.29	55.00	12611.22
L	680.56	117.34	45.00	5280.21
I	438.25	75.56	35.00	2644.61
II	396.36	68.34	27.50	1879.29
p.w.v.m'	397.04	68.46	17.14	1173.32
p.w.m'	29.75	5.13	17.14	87.92
Σ	3271.87	564.12		23676.57
Sample plot 4				
Assortment structure	Quantity		Price	Value of assortments by price list of PE
	m ³	m ³ /ha	€/m ³	€/ha
F	1235.29	186.60	55.00	10262.98
L	456.85	69.01	45.00	3105.48
I	315.84	47.71	35.00	1669.85
II	199.86	30.19	27.50	830.23
p.w.v.m'	248.78	37.58	17.14	644.12
p.w.m'	103.06	15.57	17.14	266.84
Σ	2559.68	386.66		16779.50

By applying the method of NPV (investment appraisal) it can be observed at the end of rotation (production cycle), *i.e.* different age, revenues were in a range 11,088 to 13,676.36 €·ha⁻¹, respectively. The values for NPV at a discount rate of $r=12\%$ were negative in all studied plots, and ranged from -1 743.02 to -2 161.99 €·ha⁻¹, Table 4).

Applying sensitivity analysis for NPV it is observed positive NPV values for $p=4\%$ for all studied plots. At a discount rate of 4%, NPV ranged from 310 to 2 054 €·ha⁻¹.

NPV depends of the actual investments in plantations, the height and arrangement of annual cash receipts and annual cash issuance during the use of plants, the length of the period of use for the time being, the height of calculative interest rate (Clason 2003).

Table 4. Revenues and costs, NPV and the NPV_s at discount rate 12% in the 4 studies plots.

SP	Year	C	R	C _r	R _r	C _{rs}	R _{rs}	$\frac{\sum R_r - \sum C_r}{NPV}$
								(€·ha ⁻¹)
1.	26	3857,77	12.144,08	202,61	637,82	3.015,57	1.176,97	-1.838,60
	Σ	/	/	3.015,57	1.176,97			
2.	24	3.031,75	11.088,3	199,74	730,52	3.012,70	1.269,68	-1.743,02
	Σ	/	/	3.012,70	1.269,68			
3.	37	5.513,48	23.676,36	83,25	357,48	2.896,20	896,63	-1.999,57
	Σ	/	/	2.896,20	896,63			
4.	42	3.727,64	16.779,22	31,94	143,75	2.844,90	682,91	-2.161,99
	Σ	/	/	2.844,90	682,91			

C – costs; R – revenues, C_r – discounted cost, R_r – discounted revenue, C_{rs} – average relative cost (divided by age of plantation), R_{rs} – average relative revenue, NPV – net present value, NPV_s – average net present value (divided by age of plantation).

The internal rate of return (IRR) for 4 studied plots was found to be in the range 4.32 to 5.84% (Table 5). The IRR values higher than 12% were not found in researched framework of cost-revenues changes rate. Priority in investment, have the stands with higher IRR. Average IRR is 5.22 for four studied plots. IRR values are higher for plantations that are up to habitats that are more appropriate for poplars (alluvial semigley), as well as shorter rotation and *vice versa* (Eriksson 2002).

The observed features, which include soil type and age of plantation, are the directions in which plantations of poplars can be directed if would be an effective investment, even for an interest rate that represents the upper limit for the cost-effectiveness of investing in poplar and is 6% (van Oosten 2006).

Table 5. Values of IRR (at $p=12\%$) for studied plots.

Study plot no.	IRR (%)
1.	5.20
2.	5.51
3.	5.84
4.	4.32

Pay back period (PBP) method predict the degree of economic effectiveness of investments in poplar cultivation. Agricultural crops such as apples, blackberries, and even plantations of walnuts PBP of 5-7 years (Vasiljević 1995). Such long periods of PBP are not present in any economic sector, because the comparison with other industries, including agriculture is unnecessary (Kasholi 2010). The most favourable situation for investments is the discount rate of 2%, where the period ranges between 14-20 years (Table 6). B/C varied in the range 0.42 – 0.24 (average 0.34%) at a discount rate of 12%.

Table 6. Pay back period for all studied plots (p=6%, 4% and 2%)

Study plot no.	1	2	3	4
p (%)				
		year		
6	33	29	41	80
4	21	19	22	38
2	15	14	14	20

To find out the optimal solution in the framework of the enterprise management to aim financial resources to reduce the costs or increase the revenues, by finding optimal solution and direct and advise the forestry practice to reduce the costs of production (in production phases, reduce the costs of ground and soil preparation, advance the working organization in the forest) (Keča et al. 2012).

The literature shows that the discount rate of 12% and a slight increase of input (labor costs, the price of seedlings, fuel prices, chipping stumps, deep plowing) expenses made during the growing poplar, may lead to reduction in the rate to around 6% (Jain and Singh 2000).

CONCLUSIONS

From the conducted analysis it can be concluded following:

- costs are present in the first six years of establishment of plantation,
- revenues are present during the schematic thinning and at the end of the rotation,
- by applying the method of NPV revenues were in a range 11,088 to 13,676.36 €·ha⁻¹,
- at a discount rate of r=12% NPV were negative in all studied plots, and ranged from -1,743.02 to -2,161.99 €·ha⁻¹,
- average IRR is 5.22 for four studied plots,
- the most favourable situation for investments is the discount rate of 2% for PBP, where the period ranges between 14-20 years,
- B/C varied in the range 0.42 – 0.24 (average 0.34%) at a discount rate of 12%.

Positive financial effect can be reached in the future by lowering the costs of establishing of poplar plantations. Costs can also be reduced by finding out the solution in the field of soil preparation for afforestation, working operations which will show the higher level of economic efficient. Characteristics like type of soil and age of stands are

directions in which can be found the solutions for raising of plantations of poplars in future. In practice it is necessary to improve the position of poplar producers in getting the deficient financial means for the investment in poplar cultivation, which is one of the shortest rotation periods in forestry.

REFERENCES

- Campbell H.F., Brown R.P.C. (2003). Investment Appraisal: Decision-Rules. In: Benefit-cost analysis. Pp. 36-61.
- Clason T.R. (2003). Land-Use Management for the Future, Proceedings of the 6th North American Agroforestry Conference, Association for Temperate agroforestry, Columbia, Missouri, USA. Pp. 52-60.
- Eriksson H.M., Hall, J.P., Helynen, S. (2002). In Richardson, J., Björheden, R., Hakkila, P., Lowe, A. T., Smith, C.T. (eds.). Bioenergy from sustainable forestry: Guiding principles and practice. Kluwer Academic Publishers, The Netherlands. pp. 1-17.
- Jain S.K., Singn P. (2000). Economic analysis of industrial agroforestry: poplar (*Populus deltoides*) in Uttar Pradesh (India), Agroforestry Systems 49, Kluwer Academic Publishers, Netherland. Pp. 255-273.
- Kashkoli B., Bahrami S. (2010). A comparison of engineering economy of poplar plantation with cultivation of some agricultural crops, Trakia Journal of Sciences, Vol. 8, No 2: 52-61.
- Keča Lj., Pajić S. (2010). Financial Aspects of Restoration in Poplar Plantations with Technology of Full Ground and Soil Preparation, Global Change, challenges for Soil Management, Advances in Geocology No. 41., Editor Miodrag Zlatić, Catena Verlag GMBH. Pp. 321-334.
- Keča, Lj. (2010a). Estimation of cost-effectiveness of poplar wood production in Ravni Srem by applying the net present value method. Bulletin of the Faculty of Forestry 101: 81-100.
- Keča, Lj. (2010b). Assessment of cost-efficiency for wood production in poplar plantations in Ravan Srem, based on internal rate of return. Bulletin of the Faculty of Forestry 102: 25-40.
- Keča Lj. (2011a). Estimation of cost-effectiveness of poplar wood production in poplar plantations in Ravni Srem based on the method of pay back period. Bulletin of the Faculty of Forestry 103: 41-56.
- Keča Lj. (2011b). Estimation of cost-effectiveness of poplar wood production in poplar plantations in Ravni Srem based on the cost-benefit method. Bulletin of the Faculty of Forestry 104: 81-96.
- Keča Lj., Keča N. (2014). Investment Appraisal in poplar Plantations in Serbia and it's Relations with Sustainable Land Management, in „Challenges: Sustainable Land Management – Climate Change“, Advances in Geocology No. 43., Editors: Miodrag Zlatić and Stanimir Kostadinov, Catena Verlag GMBH. Pp. 287-297.
- Keča Lj., Keča, N., Pajić, S. (2011.) Investment Appraisal of Poplar Plantations in Serbia, Baltic Forestry 17 (2): 268-279.
- Keča Lj., Keča, N., Pantić, D. (2012). Net Present Value and Internal Rate of Return as indicators for assessment of cost-efficiency of poplar plantations: a Serbian case study, International Forestry Review 14 (2): 145-156.
- Sredojević Z. (1998). Procena vrednosti višegodišnjih zasada, Beograd, Poljoprivredni fakultet. 130 p.
- van Oosten C. (2006). Crop Density for Hybrid Poplar In The Prairie Provinces, Summary Report, 200501 - Poplar Crop Density. 62 p.
- Vasiljević Z. (1998). Ekonomska efektivnost investicija u poljoprivredi. Zadužbina Andrejević, Beograd 153 p.

THE INFLUENCE OF PLANTING DENSITY ON THE STRUCTURE QUALITY OF THREE TYPE 1/1 CLONES OF EASTERN COTTONWOOD (*POPULUS DELTOIDES* BARTR. EX MARSH) PLANTED ON THE FLUVISOL SOIL TYPE

Rebić Milan, Vilotić Dragica, Andrašev Siniša, Rončević Savo

Rebić M., Vilotić D., Andrašev S., Rončević S. (2015). The influence of planting density on the structure quality of three type 1/1 clones of eastern cottonwood (*Populus deltoides* Bartr. ex Marsh) planted on the fluvisol soil type. In: Ivetić V., Stanković D. (eds.) Proceedings: International conference Reforestation Challenges. 03-06 June 2015, Belgrade, Serbia. Reforesta. pp. 242-250.

Abstract: One of the main goals of nursery production is to select the most appropriate technology for production of seedlings of certain poplar clones, which yield the maximum number of seedlings of predetermined quality for afforestation.

The paper shows the impact of three different planting densities on the productivity of three 1/1 clones of eastern cottonwood: B-229, 665 and S₁₋₅ (*Populus deltoides* Bartr. Ex Marsh). The research was carried out in the nursery "Ljutovo" in Novi Becej (Serbia), on the loamy-sandy soil of the fluvisol type. Cuttings were planted at three different distances: 0.70 m x (0.20 m, 0.30 m and 0.40 m), in 4 replicates in a randomized design. After one vegetation period, seedlings were classified according to height in the following classes: class I (>3.0 m), class II (2.5–3.0 m), class III (1.8–2.5 m), and no class (<1.8m).

The results show a significant effect of density on seedling survival, mean diameter, height, and the participation of seedlings in each height class, while a significant impact of clone on seedlings survival was observed. The decrease of planting density leads to the higher frequency of seedlings of all three clones in the upper quality grades. The frequency of seedlings of clones B-229 and 665 in class I ranges from 30% at the highest density but up to 50% at the lowest density, whereas clone S₁₋₅ produced fewer class I trees (17%) at the highest density but up to 45% at the lowest density.

The results obtained in this research show that, depending on the poplar clone, the planting density can largely affect the structure of the produced plants.

Key words: poplar, clone, planting density, height of seedlings, class of seedlings.

INTRODUCTION

The main purpose of the nursery production, being the first phase in the production of poplar wood, is to provide the planting material of predetermined characteristics that would guarantee maximum root striking and survival of the seedlings after being planted, as well as successful further growth of newly-established poplar plantations. Organised nursery production is aimed at producing the maximum number of seedlings of specific growth parameters per hectare that are possible to grow on the terrain of the given characteristics and bearing in mind the purpose of the future plantation.

The production of the poplar wood takes place in the flood plains of rivers, in habitats with large variability of hydrological conditions (Herpka 1979) and soil characteristics in small spaces (Živanov 1982). Poplar plantations may be grown for various purposes: for timber production, fiber production, or biomass to be turned into energy (Marković et al. 1997).

Depending on the chosen habitat and the purpose of a plantation, various factors condition the success of the nursery production: soil type, especially the characteristics of physiologically active profile (50–70 cm in depth), the availability of nutrition and water, the choice of a poplar clone, the planting distance, the application of agrotechnical measures (digging, spraying), and the protection of seedlings from biotic and abiotic factors (Herpka and Marković 1974, Marković 1974, 1991, Marković and Rončević 1986, 1995, Živanov 1974, Živanov et al. 1985, Ivanišević 1991, Rončević et al. 2002, Andrašev et al. 2002, 2003, 2009).

The planting density in the nursery, i.e. the specific system of planting distances, is one of the basic elements that determines the quality structure of the planting material. Based on the long-standing research of the elements of nursery production performed at the Institute of Lowlands Eorestry Environment in Novi Sad (formerly known as the Poplar Institute), it has been concluded that there is no uniform method of planting material production, but that the production of seedlings must be based on the specific purpose of the future plantation and the specific conditions in the habitat (Marković and Rončević 1986, 1995).

The basic characteristic of poplar wood production is a continual change of the clone (cultivar) range, due to their sensitivity to pathogens when they are planted in monoclonal plantations on large areas of land (Andrašev 2008, Andrašev et al. 2009).

The impact of various planting densities on the production of different types of seedlings of the selected clones of the eastern cottonwood species of the *Aigerois* section, point to the specific reaction of a clone to different planting distances, therefore it is not possible to talk about the universal method that can be applied to all the clones, but it is necessary to define a specific method of seedling production for every clone or a group of clones (Andrašev et al. 2002, 2003, 2009).

One of the main presumptions of a successful growing and high productivity of a poplar plantation is the quality of the planting material used in establishing the plantation (Žufa 1961, Bura 1968, Herpka and Marković 1974).

Planting material selected for establishing a plantation should be of certain dimensions. In practice so far, height and diameter of a seedling, measured at specific height (1.0 m, 1.3 m), have been used as indicators of a seedling's quality. Although previously used in classifying seedlings of clone I-214, the diameter of a seedling cannot be considered acceptable as a uniform criterion, since seedlings of different clones at the same heights have significantly different diameters (Andrašev et al. 2002). Classification of seedlings according to their height turned out as a suitable criterion (Herpka and Marković 1974, Marković 1974, 1991, Marković and Rončević 1986, 1995, Živanov 1974, Živanov et al. 1985, Ivanišević 1991, 1993, Rončević et al. 2002, Andrašev et al. 2002, 2003). The height of a seedling has no effect on the elements of growth developed later, but it affects the survival rate of the seedling after its plantation, which can considerably reduce the

amount of produced poplar wood (Marković 1974, 1991). That is why a number of authors specify the value of 2.5 m as the minimum height of a seedling that does not affect the survival rate of the seedling and its further growth on the plantation, and in the exceptional cases, on habitats with little risk of successful afforestation, a value of 2.0 m (Marković 1991, Marković and Rončević 1986, 1995, Ivanišević 1991, Rončević et al. 2002, Andrašev et al. 2002, 2007). Current legislation classifies seedlings according to their heights (2009), which is in line with the presented research results.

The purpose of this paper is to show the significance of planting density in the survival rate and the quality structure of rooted cuttings, in line with the current legislation, of three clones of eastern cottonwood currently in the process of selection, in producing type 1/1 seedlings, as well as to examine a possibly quantities of produced seedlings in each height class.

MATERIAL AND METHODS

The experiment was set up in spring 2012 in Nursery "Ljutovo" in Novi Bečej, which is an organizational unit of Public Enterprise "Vojvodinašume", Forestry Ground "Banat" Pančevo, Forestry Management Zrenjanin. The experiment was conducted on the loamy-sandy soil of the fluvisol type, with the cuttings of three clones of eastern cottonwood of the section *Aigerois* (Duby):

1. *Populus deltoides* cl. "BORA";
2. *Populus deltoides* cl. 665;
3. *Populus deltoides* cl. S₁₋₅.

In practice, clone BORA goes by the name B-229, therefore that name will be used from this point on.

Fifty 20 cm-long cuttings were taken from each clone, and planted at three different planting distances:

- A – 0.70 m × 0.20 m (71,429 cuttings/ha);
- B – 0.70 m × 0.30 m (47,619 cuttings/ha);
- C – 0.70 m × 0.40 m (35,714 cuttings/ha).

At the end of the vegetation period, the height of all the rooted cuttings was measured by the leveling rod graduated in centimetres, and their diameters, at the height of 1.0m above ground, by the calliper graduated in millimetres. The heights measured were used for determining the rooted cutting survival rate and elements of their structure. The number of rooted cuttings produced in 1ha of land was determined by the values of the survival rate and the total number of rooted cuttings that can be produced with the chosen planting density.

The difference between mean values of measured factors (clone and planting density) was tested by variant analyses and LSD test at the significance level of 95% ($\alpha=0.05$), where a transformation of survival rate is calculated by formula:

$$z = \arcsin \sqrt{\% \text{ survival}}$$

to get a normal distribution. As for the variant analyses, a mixed model of two-way ANOVA test is used (Hadživuković 1973):

$$X_{ijk} = \mu + \alpha_i + \beta_j + \varepsilon_{ij} + \delta_{ijk}$$

where μ represents general surroundings, α_i is the effect of a clone, β_j is the effect of the planting density, ε_{ij} is the effect of the interaction between the clone and the planting density, and δ_{ijk} is random effect.

The rooted cuttings were classified into height classes postulated in the Regulations on determining quality of poplar and willow reproductive material (hereinafter: Regulation), which stipulates the following classes of seedlings according to their height: **class I** – seedlings higher than 3.0 m, **class II** – seedlings between 2.5 m and 3 m high, **class III** – seedling between 1.8 m and 2.5 m high, and **noclass** – seedling lower than 1.8 m.

Data were processed by means of data analysis software system STATISTICA, ver. 7.1, and Microsoft Excel 2010.

RESULTS

Survival rate, mean height and mean diameter of rooted cuttings

The survival rate of rooted cuttings of the 1/1 type is significantly influenced by the type of clone and the planting density, as proved by the two-way ANOVA test. The survival rate of the tested clones ranges between 83% and 90%. The highest mean survival rate is perceived in the B-229 clone – 88,7%, and the lowest with the S₁₋₅ clone – 85.5%. Density treatment C, which denotes the lowest tested planting density, gives significantly higher survival rate of the type 1/1 rooted cuttings at the end of vegetation period (Table 1 and 2).

Table 1. Results of two-way ANOVA impact of clone and planting density on survival rate and mean values of type 1/1 rooted cuttings of the tested cottonwood clones

Source of variation	d.f.	Survival rate				Mean height of rooted cuttings				Mean diameter of rooted cuttings			
		SS	MS	F	p	SS	MS	F	p	SS	MS	F	p
Clone	2	0.0130	0.0065	4.0	0.0301	1.192	596	0.83	0.4468	4.574	2.287	0.539	0.5892
Planting density	2	0.0238	0.0119	7.3	0.0029	13.089	6.545	9.119	0.0009	120.61	60.304	14.223	0.0001
Cl* Pl. density	4	0.0075	0.0019	1.2	0.3522	114	29	0.04	0.9968	0.456	0.114	0.027	0.9985
Error	27	0.0439	0.0016			19.376	718			114.47	4.24		
Total	35	0.0083				33.771				240.11			

Mean height and mean diameter of type 1/1 rooted cuttings are significantly influenced by the planting density, while a significant impact of clone is not determined. The impact of clone and planting density interaction to both survival rate and mean height and diameter is not confirmed either (Table 1).

Mean height of type 1/1 rooted cuttings ranges from 235 cm to 296 cm, while mean diameter ranges from 13.3 mm to 18.6 mm. Mean heights and diameters of certain

clones, depending on the planting density, are within this range, and their differences are classified into homogenous groups according to LSD test.

Rooted cuttings of the clone B-229 has, on average, the greatest mean height – 273 cm, which is only 14 cm higher than the mean height of S₁₋₅ clone. The mean diameter (16.4 mm) is largest with the 665 clone, and it is only 0.9 mm larger than the mean diameter of S₁₋₅ clone. The presented differences between mean heights and diameters of different clones are not significant for the LSD test at the significance level of 0.05 (Table 2).

The planting density conditions clear classification of mean heights and diameters into homogenous groups according to LSD test at the significance level of 0.05. The highest planting density (treatment A) conditions, on average, a mean height of 242 cm, which is 23 cm lower than the mean height achieved by treatment B, and/or 46.7 cm lower than the mean heights measured by treatment C (Table 2).

Similar to the mean heights, the mean diameters of the tested clones are the smallest (13.8 cm) where the planting density is the highest (treatment A). Lower planting density in treatment B conditions, on average, 2.3 mm larger diameters of rooted cuttings, while mean diameters in treatment C were 4.4 mm larger than those in treatment A (Table 2).

Table 2. Results of LSD test at the level of 95% of impact of planting density on survival rate and mean values of type 1/1 rooted cuttings of the tested cottonwood clones

Treatment		Survival	LSD_{0.05}	Height	LSD_{0.05}	Diameter	LSD_{0.05}
Clone	Planting density	[%]		[cm]		[mm]	
B-229	A (0.70 m × 0.20 m)	88.5	a ¹	247.1	bcd	13.8	cd
	B (0.70 m × 0.30 m)	88.0	abc	275.2	abc	16.5	abc
	C (0.70 m × 0.40 m)	89.5	a	295.8	a	18.3	ab
665	A (0.70 m × 0.20 m)	87.0	abcd	242.8	cd	14.2	cd
	B (0.70 m × 0.30 m)	83.0	d	260.4	abcd	16.3	abcd
	C (0.70 m × 0.40 m)	90.0	a	286.4	a	18.6	a
S₁₋₅	A (0.70 m × 0.20 m)	84.5	bcd	235.2	d	13.3	d
	B (0.70 m × 0.30 m)	84.0	cd	258.4	abcd	15.6	bcd
	C (0.70 m × 0.40 m)	88.0	ab	283.1	ab	17.8	ab
B-229		88.7	a	272.7	a	16.2	a
665		86.7	ab	263.2	a	16.4	a
S₁₋₅		85.5	b	258.9	a	15.5	a
	A (0.70m×0.20m)	86.7	b	241.7	c	13.8	c
	B (0.70m×0.30m)	85.0	b	264.7	b	16.1	b
	C (0.70m×0.40m)	89.2	a	288.4	a	18.2	a

¹Same letters indicate that there is no statistically significant differences between the planting densities tested by LSD test at the significance level of 0.05.

Number of seedlings of different height class per hectare

According to the Regulations, the number of seedlings in certain height class per hectare differs depending of, primarily, the researched planting density, and to a lesser extent of a clone type (Figure 1). The participation of “no class” seedlings of all the three

clones is highest with the highest planting density (A), while the the lowest density (C) yields the highest participation of class I seedlings (Figure 2).

The number of rooted cuttings of the clone B-229 produced ranges from 31,964 (treatment C) to 63,215 (treatment A). With treatment A, the highest participation of seedlings is in the height class III (19.280 seedlings per hectare, or 30.5%), somewhat smaller is the participation of seedlings in class I (19,135 seedlings per hectare, or 30.3%), while the smallest participation of usable seedlings is perceived in class II (11,343 seedlings per hectare, or 17.9%). With treatment B, the largest participation of seedlings is in class I, with 18,105 seedlings per hectare (43.2%), followed by class III seedlings with 11,137 and class II seedlings with 9,339 per hectare, or 22,3%. The largest number of seedlings produced by treatment C is classified as class I (17,401 seedlings per hectare, or 54.4%), while a considerable smaller number of seedlings belong to classes II and III (Figure 1 and Figure 2).

The number of clone-665 rooted cuttings vary between 33,143 (treatment C) and 62,143 (treatment A). The largest number of usable seedlings produced by treatment A belongs to the height class I (18,558 seedlings per hectare, or 29.9%), followed by seedlings of class III and finally class II. Similar results were reached by treatments B and C, where the biggest number of usable seedlings is in class I (31.0% and 49.8%), followed by class III (22.3% and 30.0%), and the smallest number is in class II (19.0% and 25.3%).

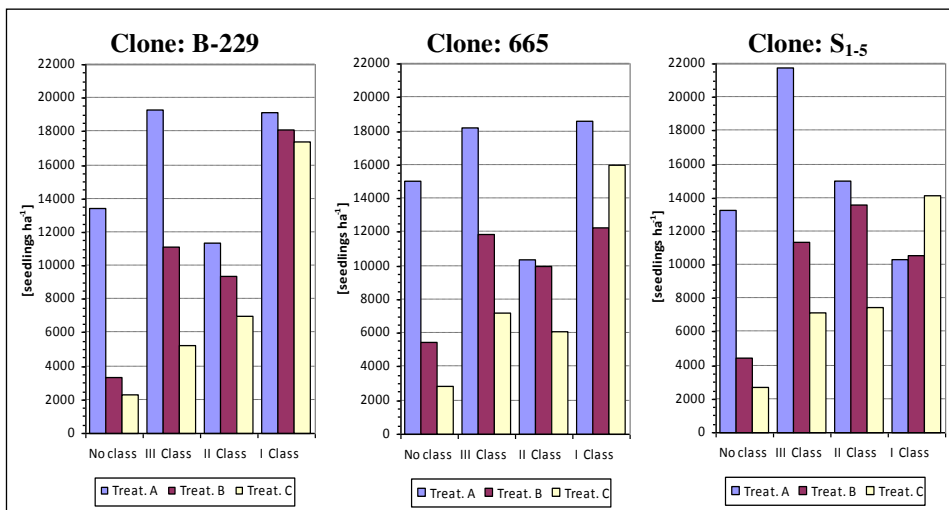

Figure 1. The number of seedlings in different height classes per hectare, depending on the clone type and the planting density.

Clone S_{1.5} yields 31,428 (treatment C) to 60,358 rooted cuttings (treatment A). The greatest number of forestry seedlings produced by treatment A is in class III (21,771 per hectare, or 36.1%), followed by those in class II, with 15,036 seedlings per hectare (24.9%), and class I, with 10,304 seedlings per hectare (16.7%). As far as the treatment B is concerned, class II is the most numerous (13,614 seedlings per hectare, or 34%), 11,356 seedlings per hectare (28.4%) are registered in class III, and the smallest number of

seedlings is in class I – 10,551 per hectare (26.4%). The largest number of seedlings produced by treatment C belongs to class I (14,155 seedlings per hectare, or 45%), while 7,411 seedlings per hectare (23.7%) are in class II, which is 258 seedlings more than registered in class III (7,153 seedlings per hectare, or 22.8%).

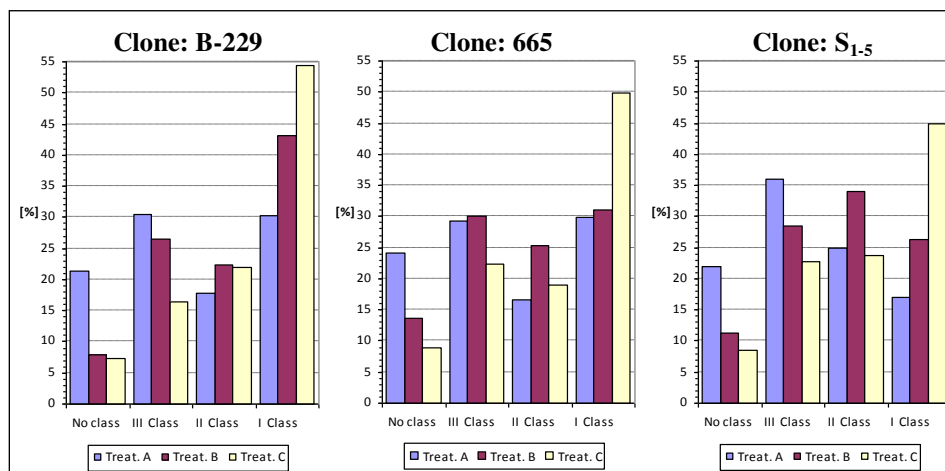

Figure 2. Relative participation of seedlings in different height classes depending on the clone and planting density.

DISCUSSION AND CONCLUSIONS

Planting density is one of the fundamental factors in plant production, significantly affecting the elements of the production. Smaller growth area, i.e. higher planting density, negatively affects the elements of growth in seedlings and can cause the dying out of plants, i.e. the reduction in the survival rate, if the growth space is reduced below the certain value. The researched clones planted at the said planting distances have high survival rates (83–90%), and the differences in their survival rates depending on the planting density are smaller, which points to the fact that the results could lead to the optimisation of production of the researched clones from the aspect of planting density.

Mean heights and mean diametres of rooted cuttings are considerably affected by applied planting densities, with no perceived differences in clones, which is in line with the conclusions of the research made by Andrašev et al. (2003), concerned with the impact of five different planting distances to the height and diametre of rooted cuttings of six different clones of hybrid poplar on the clayey soil of the fluvisol type. Considerably greater mean heights and diametres were reached in four clones of hybrid poplar with the increase of planting distances on the sandy soil of fluvisol type (Andrašev et al. 2002). However, Andrašev et al. (2009) did not establish any significant differences in heights of rooted cuttings of the three clones of hybrid poplar depending of the five researched planting densities on the sandy soil of the fluvisol type. The same authors perceived

significantly higher mean heights of seedling type 1/2 with the increased planting distances with all three researched clones of hybrid poplar.

In the selection phase of the clone B-229 there was some research of its reactions to planting density of rooted cuttings in the rooting bed, and the results show that on the clayey soil of fluvisol type with similar planting densities, mean height is 22–40 cm lower as compared to those perceived in this research (Andrašev et al. 2003). On the sandy soil of fluvisol type, with approximately the same planting densities, the B-229 clone yields 28–53 cm lower mean heights as compared to those perceived in this research (Andrašev et al. 2009).

This research, as well as the previous ones, shows that the height structure of seedlings vary more or less and that the seedlings belong to different height classes (Ivanišević 1991, Andrašev et al. 2002, 2003, 2007, 2009). Smaller planting density yields relatively greater participation of seedlings in class I with all three researched clones, which is confirmed in earlier researches as well (Andrašev et al. 2002, 2009). The results of this research show greater number of seedlings per hectare in class I (>3.0 m) with all three researched clones, as compared to the results of previous researches (Andrašev et al. 2002), which corresponds with greater mean heights achieved in this research.

When opting for a planting density it is necessary to take into the account both the absolute number of the seedlings of proper quality per hectare and their relative shares (Andrašev et al. 2009). As the current regulations on classification of seedlings and trade of planting material envisage, it is not possible to trade with seedlings that are outside the prescribed classes and they can neither be used for production of raw materials as well (Andrašev et al. 2003). Such seedlings cannot be put to adequate use and their high share in absolute and relative sense only increases the production costs.

The seedlings of class I have the highest price in the market and the widest range of use, depending on the characteristics of the habitat to be afforested, so the highest possible production of class I seedlings per hectare is most often the goal of the organised nursery production. With all three clones, the smallest density treatment (C) yields relatively the highest participation of class I seedlings (45–54%), i.e. 14,100–17,400 seedlings per hectare. All this point to the fact that in the researched conditions of nursery production, the lowest density treatment (0.70 × 0.40 m) is the best option for production of planting material of hybrid poplars.

The results of this research show that the increase in the planting distance of relatively narrow range (0.70 × 0.20 m to 0.70 × 0.40 m) leads to a linear trend of participation of class I seedlings per hectare with all three researched clones. However, earlier researches (Andrašev et al. 2002, 2009) show that wider range of planting distances results in curvilinear trend, with clearly defined maximum number of seedlings to be used per hectare within the specific planting treatment.

Therefore, these results should be taken cautiously and with reservation, and the participation of usable seedlings of the researched clones should be subjected to further research in wider range, with the view to further optimising the seedling production from the aspect of planting density.

REFERENCES

2009. Pravilnik o kvalitetu reproduktivnog materijala topola i vrba (Sl. glasnik RS", br. 76/2009).
- Andrašev S., Rončević S., Ivanišević P. (2002). Uticaj razmaka sadnje na proizvodnju sadnica tipa 1/1 selekcionisanih klonova crnih topola (sekcija *Aigeiros*). Topola (167/168): 17–40.
- Andrašev S., Rončević S., Ivanišević P. (2003). Proizvodnja repromaterijala selekcionisanih klonova crnih topola (sekcija *Aigeiros Duby*) u zavisnosti od klona i razmaka sadnje u ožilištu. Topola (171–172): 3–24.
- Andrašev S., Rončević S., Ivanišević P. (2009). Značaj domenzija sadnica tipa 1/2 na izbor optimalne gustine sadnje kod tri klona crnih topola sekcije *Aigeiros* (Duby). Topola (183/184): 55–74.
- Hadživuković S. (1973). Statistički metodi sa primenom u poljoprivrednim i biološkim istraživanjima. Radnički univerzitet „Radivoj Čirpanov“, Novi Sad.
- Herpka I., Marković J. (1969). Izbor klasa ožiljenica za proizvodnju repromaterijala. Izveštaj Instituta za topolarstvo, Novi Sad.
- Herpka I., Marković J. (1974). *Zavisnost proizvodnje dvogodišnjih sadnica topole od uzrasta ožiljenica*. Topola (102): 3–12.
- Marković J. (1970). Istraživanje vegetativnog razmnožavanja topola i vrba i utvrđivanje reagovanja različitih oblika uzgojenog sadnog materijala u fazi osnivanja zasada. Unapređenje proizvodnje mekih lišćara brzoga rasta (topola i vrba), Institut za topolarstvo Novi Sad, str. 59–65.
- Marković J. (1974). Značaj klasa (uzrasta) sadnica 2/3 u proizvodnji drvne mase klona „I-214“. Topola (100–101): 87–95.
- Marković J. (1991). Uticaj gustine sadnica u rasadniku na kvalitet sadnog materijala i na produktivnost zasada topola. Radovi – Institut za topolarstvo, Novi Sad (24): 21–38.
- Marković J., Rončević S. (1986). Rasadnička proizvodnja. „Topole i vrbe u Jugoslaviji“. Monografija. Institut za topolarstvo, Novi Sad. (133–152).
- Marković J., Rončević S. (1995). Proizvodnja sadnica. Seminar “Proizvodnja sadnog materijala vegetativnim putem u JP Srbijašume”, Novi Sad.
- StatSoft Inc. (2006). STATISTICA (data analysis software system), version 7.1.
- Živanov N. (1974). Prilog izučavanju hloroze u rasadnicima topole klona I-214. Agrohemija, 3/4: 101-108.
- Živanov N. (1982). Varijabilnost svojstava aluvijalnih zemljišta i njihov značaj za proizvodnost topola. Topola, br. 133-134: 41-47.
- Živanov N., Ivanišević P., Herpka I., Marković J. (1985). Uticaj đubrenja i navodnjavanja na razvoj topola u rasadnicima i zasadima. Radovi – Institut za topolarstvo, Novi Sad (16): 101 - 118.
- Žufa L. (1961). Rasadnici topola. Jugoslovenski savetodavni centar za poljoprivredu i Šumarstvo, Beograd. Šumarstvo (4): 1-101.

Session 5:

SPECIES, INTRA-SPECIES AND SEED SOURCE SELECTION

**BUD BURST AND HEIGHT INCREMENT OF NORWAY SPRUCE (*Picea abies* Karst.)
IN PROGENY TESTS IN BOSNIA AND HERZEGOVINA**

Cvjetković Branislav*, Mataruga Milan, Šijačić-Nikolić Mirjana, Daničić Vanja, Lučić Aleksandar

*Corresponding author: cvjetkovicb@gmail.com

Cvjetković B., Mataruga M., Šijačić-Nikolić M., Daničić V., Lučić A. (2015). Bud burst and height increment of Norway spruce (*Piceaabies* Karst.) in progeny tests in Bosnia and Herzegovina. In: Ivetić V., Stanković D. (eds.) Proceedings: International conference Reforestation Challenges. 03-06 June 2015, Belgrade, Serbia. Reforesta. pp. 251-259.

Abstract: In 2009, on the territory of the Republic of Srpska (Bosnia and Herzegovina), two progeny tests of Norway spruce were established in Drinić (Inner Dinarides area) and Srebrenica (Transitional Illyrian-Moesian area). The tests included 36 half-sib lines from six populations from Bosnia and Herzegovina.

From May 2nd to 15th 2013 in Drinić, and April 23rd to May 8th 2013 in Srebrenica, the opening of terminal buds (bud burst) at the population level was observed 3 times (in total: 2469 seedlings in Srebrenica and 2177 seedlings in Drinić). The results obtained by observations correlated with seedlings height increment in 2013.

The results indicate significant differences for bud burst and height increment of seedlings at population level. The correlation between bud burst and height increment was not determined.

This study may be the first step in defining the populations of spruce in B&H with early and late bud burst, and the separation of populations by height increment in the early stage. It is important when selecting populations as seed sources for future seedlings production and planting in different areas, which refers to assisted migration.

Key words: Norway spruce, bud burst, increment.

INTRODUCTION

Afforestation in Europe and worldwide requires the application of planting material adapted to climate changes with greater production of wood and at minimal risks. Early onset and late cessation of growth of tree species give rise to frequent frost damage, whereas late onset and early cessation result in loss of growth resources at the site (Heide 1985). Gathering information about the variability of physiological traits in correlation with growth for economically important species represents a modern approach to the management of forest genetic resources.

In the forestry of the Republic of Srpska and B&H Norway spruce is one of the most important forest tree species. In the seedlings production in the Republic of Srpska,

Norway spruce has a share of about 60% of the total number of seedlings (Mataruga et al. 2012).

In Europe Norway spruce has been subjected to different research. Thus, the bud burst of has been described as biochemical process (Dhule 2014), while Yakovlev et al. (2014) wrote about the differences in transcription of DNA and creating different enzyme products originating from the same genes in different environmental conditions. Petit et al. (2011) write about the changes in xylogenesis and morphological changes in provenance tests set out in various environmental conditions which may affect the growth. Bud burst predicting on the basis of internal and external indicators described by Sutinen et al. (2012). Bud burst can be genetically controlled (Gyllenstrand et al. 2007, Yakovlev et al. 2008, Gömöry et al. 2015).

While testing spruce trees in the "whole tree" laboratory, Slaney et al. (2006) found out that the elevated temperature affects the earlier budburst and the early start of elongation of terminal shoots. The same research has shown that more frequent intervals of warmer weather prolong the time of shoot elongation as well as the appearance of anatomical modifications in the terminal buds (Gorsuch and Oberbauer 2002, Danby and Hik 2007).

Hannerz (1999) described the temperature model for estimating the influence of temperature on budburst. Olsson and Jönsson (2014) determined several predictive models for Europe. Spring phenology of temperate forest trees is optimized to maximize the length of the growing season while minimizing the risk of freezing damage (Søgaard et al. 2007, Viherä-Aarnio et al. 2014, Basler and Korn 2012). Šijačić-Nikolic et al. (2000) and Ivetić (2004) worked on the research done in field trials in former Yugoslavia, while in the area of B&H there was no research due to the lack of field trials.

OBJECT OF RESEARCH AND METHOD

Four progeny tests of Norway spruce were established in 2009. Six populations of Norway spruce (Table 1) from the entire natural range in Bosnia and Herzegovina marked in Figure 1 as red points were chosen to be tested. In each population, ten "plus" trees of Norway spruce were selected – in total 60 trees. In 2009, 36 half-sib lines were chosen as the best representatives of their original populations and planted in progeny tests.

Table 1. Characteristics of sites where the seeds were collected.

Provenance	Latitude	Longitude	Altitude [m]	Eco-vegetation district	Habitat
Han Pijesak 1	44°08'13"	18°50'01"	1000-1100	Internal Dinaric	<i>Piceo-Abieti-Fagetum</i>
Han Pijesak 2	44°02'09"	19°00'11"	960-1040	Internal Dinaric	<i>Piceo-Abieti-Fagetum</i>
Foča	43°24'58"	18°52'39"	1000-1126	Internal Dinaric	<i>Abieti -Piceetum</i>
Olovo	44°07' 43"	18°34' 54"	900-1000	Internal Dinaric	<i>Piceo-Abieti-Fagetum</i>
Potoci	44°23' 12"	16°39'39"	850-950	Internal Dinaric	<i>Piceo-Abieti-Fagetum</i>
Kneževo	44°28'59"	17°24'46"	1010-1030	Internal Dinaric	<i>Piceo-Abieti-Fagetum</i>

Only 2 progeny tests (Drinić and Srebrenica) are still representative for the research and these two were investigated. Locations of progeny tests are represented by

blue squares (Table 2, Figure 1). Seed stands where seed was collected are represented by red squares (Figure 1). The characteristics of the habitat are given in Table 2. Progeny tests consist of 4 blocks. The blocks consist of 6 populations. In the six populations there are 36 half-sib lines, where each population has a different number of half-sib lines (from 2 to 9).



Figure 1. Location of seed sources (red points) and progeny tests (blue squares).

Table 2. Characteristics of sites where progeny tests are established.

Locality	Latitude	Longitude	Altitude [m]	Habitat	Type of soil
Drinić	44°31'10"	16°36'04"	690	<i>Piceo-Abieti-Fagetum</i>	Calkomelanosol, luvisolcalkocambisol
Srebrenica	44°01'34"	19°25'22"	1000	<i>Piceo-Abieti-Fagetum</i>	Districcambisol

Data collecting

Bud burst data were collected from 4 blocks, while height increment was observed in three blocks. In Srebrenica, the data was collected in the following periods: April 24th to 25th, April 29th to 30th, and May 7th to 8th 2013. The data were collected in Drinić on: May 2nd, May 7th and May 15th 2013. Height increment data were collected at the end of the vegetation period. Data processing was performed by using software packages Excel and Statistica 7. Rank correlation (Spearman correlation) was applied for establishing the correlation. Each observation (first, second and third) was correlated with increment.

RESULTS AND DISCUSSION

Progeny tests at Drinić site

Bud burst in three observations indicates a head start for seedlings originating from Kneževo (Table 3). In the first and second observations, Kneževo population had a higher number of seedlings with bud burst in comparison to other populations. In the last

observation, Kneževopopulation had a 4% lower bud burstcompared to the maximum bud burst attained by the populations Potoci and Foča.

Table 3. Bud burst in progeny test Drinić.

Population	N	1 st observation		2 nd observation		3 rd observation		Increment	
		AS	St.dev.	AS.	St.dev.	AS.	St.dev.	i _h	St.dev.
Han Pijesak1	150	0.08	0.23	0.17	0.35	0.89	0.24	9.92	4.47
Han Pijesak 2	283	0.10	0.24	0.28	0.41	0.93	0.19	10.62	4.79
Foča	449	0.05	0.17	0.28	0.38	0.93	0.20	11.21	4.81
Potoci	443	0.08	0.23	0.29	0.39	0.94	0.18	11.53	5.40
Olovo	427	0.08	0.21	0.31	0.39	0.94	0.19	12.00	4.87
Kneževo	425	0.13	0.28	0.34	0.42	0.90	0.25	10.03	4.12
TOTAL	2177	0.09	0.23	0.29	0.40	0.93	0.21	10.96	4.83

The second observation indicated most prominent differences among populations. All populations, except Han Pijesak 1, react similarly to temperature fluctuations between the first and third observations. It is possible that there is a difference in the inherited predisposition of Han Pijesak 1 population to open the buds, which might regulated by the corresponding genes (Karlgrén et al. 2013). The above-mentioned population should be counted on in future transfers in to the habitats where there is a real risk of late frosts in order to prevent damage to the terminal bud. Olovo and Potoci populations have reached the largest increment in seedlings height. The obtained variability is large, which indicates the need for the analysis at a lower level – at the level or half-sib lines.

Spearman correlation for bud burst and height increment was: -0.39 for the first observation, 0.40 for the second and 0.97 for the third observation. Although Spearman coefficients show a high value, weshould bear in mind that there is no significant differentiation of populations at the end ofthe observation - only 5%, which isat the level of statistical error.

The analysis of variance indicates the existence of significant differences ($p < 0.05$) at population level for all three observations (Table 4). As for the first observation, Duncan test (Table 5) indicates the existence of three homogenous groups in which the third homogeneous group with Foča populationcharacterized by the lowest percentage of bud burstsignificantly stands out. The resultsof Dunacan test for the second observation indicated that population Han Pijesak 1 was in a separate homogeneous group with the lowest percentage of buds burst. The results of Duncan test for thethird observation divided theobtained data into two homogenous groups without revealing the presence of significant differences. Bud burst differences were reduced to only 5%, which is the difference between the minimal bud burst in Han Pijesak 1 and maximal bud burst recorded in populations Potoci and Olovo.

In the research conducted by Mataruga et al. (2012), populations Han Pijesak 1 and Kneževo attained the best results in the progeny test. Those populations which had the largest increment 4 years ago had the smallest increment in 2013. Populations Olovo and Potoci attained the best results. The cause could be found in a very dry year and better adaptation to drought.

Table 4. ANOVA for budburst and height increment in progeny test Drinić.

	Source	Df	SS	MS	F	p
Bud burst	Populat.	5	1.66	0.33	6.13	0.0000
	Error	2172	117.43	0.05		
	Total	2177	119.09			
	Source	Df	SS	MS	F	p
	Populat.	5	3.29	0.66	4.22	0.0007
	Error	2172	338.45	0.16		
	Total	2177	341.74			
	Source	Df	SS	MS	F	p
	Populat.	5	0.62	0.12	2.93	0.0122
Error	2172	92.47	0.04			
Total	2177	93.09				
Increment	Source	Df	SS	MS	F	p
	Populat.	5	915.1	183.0	8.013	0.0000
	Error	1573	35928.7	22.8		
	Total	1578	36843.9			

Table 5. Duncan test for bud burst and height increment in progeny test Drinić.

Population	Mean	Homog. groups	Populations	Mean	Homog. groups
Observation 1			Observation 2		
Foča	5	X	Han Pijesak 1	17	X
Han Pijesak 2	8	X	Foča	28	X
Olovo	8	X	Han Pijesak 2	28	X
Potoci	8	X	Potoci	29	X
Han Pijesak 1	10	XX	Olovo	31	X
Kneževo	13	X	Kneževo	34	X
Population	Mean	Homog. groups	Population	Mean	Homog. groups
Observation 3			Increment		
Han Pijesak 2	89	X	Han Pijesak 1	9.92	X
Kneževo	90	X	Knezevo	10.03	X
Foča	93	XX	Han Pijesak 2	10.62	XX
Han Pijesak 1	93	XX	Foca	11.21	XX
Olovo	94	X	Potoci	11.53	X
Potoci	94	X	Olovo	12.00	X

Progeny tests at Srebrenica site

In the progeny test in Srebrenica, at the end of the observation period, population Kneževo had the highest bud burst (80%). In the three observations, as well as for the progeny test Drinić, the most interesting results were obtained during the second observation (Table 6). More precisely, three populations singled out: Han Pijesak 2, Potoci and Foča, with a smaller percentage of bud burst during the second observation. Unlike progeny test in Drinić, three populations respond to environmental conditions with

reduced bud burst. It is assumed that in this case the impact of the external environment outweighed, and, apart from external conditions, the cause should be looked for in an earlier observation.

In comparison to the research conducted in 2010 (Mataruga et al. 2012), the growth dynamics was not significantly changed. The populations with the highest increment were Potoci and Olovo.

Table 6. Bud burst in progeny test Drinić.

Population	N	1 st observation		2 nd observation		3 rd observation		Increment	
		AS	St.dev.	AS.	St.dev.	AS.	St.dev.	AS.	St.dev.
Han Pijesak1	277	0.07	0.26	0.32	0.47	0.76	0.43	9.3	4.7
Han Pijesak 2	187	0.02	0.13	0.20	0.40	0.70	0.46	8.7	4.8
Foča	555	0.04	0.19	0.22	0.41	0.67	0.47	8.1	4.1
Potoci	480	0.04	0.19	0.21	0.41	0.73	0.45	9.8	5.5
Olovo	392	0.06	0.24	0.30	0.46	0.79	0.41	10.2	6.0
Kneževo	578	0.04	0.21	0.36	0.48	0.80	0.40	8.3	4.6
TOTAL	2469	0.05	0.20	0.27	0.44	0.74	0.44	9.0	5.0

Spearman coefficient was 0.15 for the first observation, for the second it was - 0.31; and in the last one, the third one, it was 0.94. As in the case of the progeny test in Drinić, the differences in height increment and bud burst were more significant in comparison to the progeny test in Drinić. The fact is that the population with the least bud burst in three observations (Foča), had the smallest height increment (Table 6). However, the population Kneževo which had the largest percentage of bud burst had almost the smallest height increment. Also, the increment difference between the minimum (Foča) and maximum (Olovo) was only 2 cm which is not enough to talk with certainty about the correlation between the bud burst and seedlings increment.

Table 7. ANOVA for budburst and height increment in progeny test Srebrenica.

	Source	Df	SS	MS	F	p
Bud burst	Population	5	15.95	3.19011	0.76	0.5752
	Error	2464	10279.51	4.17188		
	Total	2469	10295.46			
	Source	Df	SS	MS	F	p
	Population	5	6.416	1.283	6.80	0.0000
	Error	2464	467.651	0.189		
	Total	2469	474.068			
	Source	Df	SS	MS	F	p
	Population	5	0.62	0.12	2.93	0.0122
	Error	2164	92.47	0.04		
Total	2169	93.09				
Increment	Source	Df	SS	MS	F	p
	Population	5	1088.9	217.8	8.952	0.000000
	Error	1597	38848.1	24.3		
	Total	1602	39936.9			

The analysis of variance obtained on the basis of the input data for the first observation indicated no statistically significant differences among populations. The cause is probably supposed to be looked for in the early beginning of the bud burst monitoring in Srebrenica progeny test.

The analysis of variance conducted for the third observation showed a statistically significant difference at the level of populations (Table 7). Duncan test (Table 8) indicated significant heterogeneity of data for second and third observation. The results differ significantly from the results obtained in the progeny test in Drinić, which leads to the conclusion that we need a more detailed study of micro site conditions, as well as multiple observations in order to be able to make more accurate conclusions and consequently recommendations for the transfer of planting material from populations that have been tested in two progeny tests.

Table 8. Duncan test for budburst and height increment in progeny test Drinić

Population	Mean	Homog. groups	Populations	Mean	Homog. groups	Population	Mean	Homog. groups
Observation 1			Observation 1			Increment		
Han Pijesak 2	89	X	Foča	67	X	Foča	8.15	X
Kneževo	90	X	Han Pijesak 2	70	XX	Knezevo	8.30	X
Foča	93	X X	Potoci	73	XXX	Han Pijesak 2	8.66	XX
Han Pijesak 1	93	X X	Han Pijesak 1	76	XXX	Han Pijesak 1	9.33	XX
Olovo	94	X	Olovo	79	XX	Potoci	9.81	X
Potoci	94	X	Kneževo	80	X	Olovo	10.22	X

In their papers on genetic markers of Norway spruce, Ballian et al. (2007, 2009) and Ballian (2010) indicate significant variability on the level of Bosnia and Herzegovina. In this regard, a different response of spruce populations to new environmental conditions in the progeny tests can be expected. Although significantly large differences in bud burst and height increment still have not been determined, they are expected to be expressed in the future.

CONCLUSIONS

Progeny test in Drinić pointed to one population - Han Pijesak 1, as the population with the slowest bud burst due to the lowest percentage of bud burst. The observed population had the smallest height increment which leads us to the preliminary conclusion that there is a correlation between the dynamics of the bud burst and height increment. However, a difference in bud buds not greater than 5% is not sufficient to enable making firm conclusions about the correlation between bud burst and height increment. Population Han Pijesak 1 did not show the same result in progeny test in Srebrenica, so the conclusion would be to continue the research and to pay attention to the above-mentioned population. The difference in height increment between two extremes is only 2 cm, which emphasizes the need for further research in later stages of the development of seedlings. The correlation between bud burst and height increment is

strong in the last, third reading. However, the differences are very small and the conclusions should be cautiously made.

In the progeny test in Srebrenica, the disparity of data in the second and third observations is somewhat higher. Three populations: Han Pijesak 2, Potoci and Foča in the second observation showed smaller bud burst than the rest of the populations. In the third observation population Foča had the lowest percentage of bud burst - 69%, while the population Kneževo had the largest percentage of bud burst with 80% of opened buds. Spearman coefficient had a high value. However, the difference of 2 cm between extremes is still small to be able to talk with certainty about the existing correlation.

The differences which were observed in the second observation in both progeny tests could be the basis for further research on the topic of correlation of bud burst and height increment of Norway spruce in the progeny tests in Bosnia and Herzegovina. Population differentiation based on the dynamics of bud burst can be used for the forest reproductive material transfer. We should bear in mind the need for more detailed and numerous observations of phenophases in order to get valuable data which could be used for the recommendations related to the transfer of reproductive material of Norway spruce.

REFERENCES

- Ballian D. (2010). Genetic diversity of forests in Bosnia and Herzegovina, Works of the Faculty of Forestry University of Sarajevo No. 2, pp: 1-9.
- Ballian D., Bogunić F., Božić G. (2007). Genetic variability of Norway spruce (*Picea abies* /L./ H. Karst.) in the Bosnian part of the Dinaric mountain range, Šumarski list br. 5–6, CXXXI, pp: 237-246.
- Ballian D., Bogunić B., Božić G. (2009). Genetic structure of *Picea abies* populations growing on extreme sites as revealed by isoenzyme markers: a case study from Slovenia and Bosnia and Herzegovina 2009, Dendrobiology vol. 61, Supplement, pp: 137–144.
- Basler D., Körne C. (2012). Photoperiod sensitivity of bud burst in 14 temperate forest tree species, Agricultural and Forest Meteorology, Volume 165, pp. 73–81.
- Basler D., Körne C. (2014). Photoperiod and temperature responses of bud swelling and bud burst in four temperate forest tree species, Tree Physiology, 34 (4), pp. 377-388.
- Danby R.K., Hik D.S. (2007). Responses of white spruce (*Picea glauca*) to experimental warming at a subarctic alpine treeline. Global Change Biology 13: 437–451.
- Dhuli P., Rohloff J., Strimbeck G.R. (2014). Metabolite changes in conifer buds and needles during forced bud break in Norway spruce (*Picea abies*) and European silver fir (*Abies alba*), Frontiers in Plant Science, Vol 5, Article 706, pp. 1-13.
- Gömöry D., Foffová E., Longauer R., Krajmerová D. (2015). Memory effects associated with early-growth environment in Norway spruce and European larch European Journal of Forest Research, Volume 134, Issue 1, pp. 89-97.
- Gorsuch D.M., Oberbauer S.F. (2002). Effects of mid-season frost and elevated growing season temperature on stomatal conductance and specific xylem conductivity of the arctic shrub, *Salix pulchra*. Tree Physiology 22, pp. 1024–1037.
- Gyllenstrand N., Clapham D., Gällman T., Lagercrantz U. (2007). Norway spruce flowering locust homolog is implicated in control of growth rhythm in conifers, Plant physiology. 144(1): 248–257.
- Hannerz M. (1999). Evaluation of temperature models for predicting bud burst in Norway spruce, Canadian Journal of Forest Research, 29(1) pp: 9-19.

- Hänninen H., Slaney M., Linder S. (2006). Dormancy release of Norway spruce under climatic warming: testing ecophysiological models of bud burst with a whole-tree chamber experiment *Tree Physiology* 27, pp. 291–300.
- Heide O.M. (1985). Physiological aspects of climatic adaptation in plants with special reference to high-latitude environments. *In* Plant Production in the North. Eds. Å. Kaurin, O. Junttila and J. Nilsen. Norwegian Univ. Press, Tromsø, pp 1-22.
- Ivetić V. (2004). Uticaj staništa i provenijencija na razvoj juvenilnih kultura smrče (*Picea abies* /L./ Karst) na Goliji. Magistarski rad. Rukopis, Šumarski fakultet. Beograd.
- Karlgren A., Gyllenstrand N., Clapham D., Lagercrantz U. (2013). *FT/TFL1*-like genes affect growth rhythm and bud set in Norway spruce (*Picea abies* L. Karst.), *Plant Physiology*, DOI:10.1104/pp.113.224139
- Mataruga M., Isajev V., Balotić P., Burlica Č., Cvjetković B. (2010). Progeny tests of Norway spruce (*Picea abies* Karst) in Bosnia and Herzegovina - contribution to the European ex situ conservation, *Proceedings*, pp. 378-389.
- Mataruga M., Isajev V., Lazarev V., Balotić P., Daničić V. (2005). Registar šumskih sjemenskih objekata Republike Srpske-osnova unapređenja sjemenske proizvodnje, Šumarski fakultet, Banja Luka, pp:1-222.
- Olsson C. Jönsson A.M. (2014). Process-based models not always better than empirical models for simulating budburst of Norway spruce and birch in Europe, *Global Change Biology*, Volume 20, Issue 11, pp. 3492–3507
- Petit G., Anfodillo T., Carraro V., Grani F., Carrer M. (2011). Hydraulic constraints limit height growth in trees at highaltitude *New Phytologist* 189, pp. 241–252.
- Šijačić-Nikolić M., Isajev V., Mataruga M. (2000). Evaluation of morphometric properties of several Spruce (*Picea abies* /L./ Karst) provenances in monocultures in Serbia. *In*: Spruce Monocultures in Central Europe - problems and prospects, *EFI Proceedings*, Joensuu: EFI, No 33, 145-153.
- Slaney M., Wallin G., Medhurst J., Linder S. (2007). Impact of elevated carbon dioxide concentration and temperature on bud burst and shoot growth of boreal Norway spruce, *Tree Physiology* 27 (2), pp. 301-312.
- Sutinen S., Partanen J., Viherä-Aarnio A., Häkkinen R. (2012). Development and growth of primordial shoots in Norway spruce buds before visible bud burst in relation to time and temperature in the field, *Tree Physiology* 32 (8): 987-997.
- Viherä-Aarnio A., Sutinen S., Partanen J., Häkkinen R. (2014). Internal development of vegetative buds of Norway spruce trees in relation to accumulated chilling and forcing temperatures, *Tree Physiology*, Vol 34, issue 5, 547-566.
- Yakovlev I.A., Asante D., Fossdal C.G., Partanen J., Junttila O., Johnsen Ø. (2008). Dehydrins expression related to timing of bud burst in Norway spruce, *Planta*, Volume 228, Issue 3, pp. 459-472.
- Yakovlev I.A., Lee Y.K., Rotter B., Olsen J.E., Skråppa T., Johnsen Ø., Fossdal C.G., (2014). Temperature-dependent differential transcriptomes during formation of an epigenetic memory in Norway spruce embryogenesis, *Tree Genetics & Genomes*, Volume 10, Issue 2, pp. 355-366.

VARIABILITY OF THE TERPENIC PROFILE OF *PINUS HELDREICHII* POPULATIONS OF THE SCARDO-PINDIC (SERBIA-KOSOVO AND REPUBLIC OF MACEDONIA) AND DINARIC MASSIFS (MONTENEGRO AND SERBIA)

**Nikolić Biljana^{*}, Ristić Mihailo, Bojović Srđan, Kovačević Dragan, Matevski Vlado,
Krivošej Zoran, Marin D. Petar**

*Corresponding author: smikitis@gmail.com

Nikolić B., Ristić M., Janačković P., Novaković J., Šarac Z., Rajčević N., Marin P. (2015). Variability of the terpenic profile of *Pinus heldreichii* populations of the Scardo-Pindic (Serbia-Kosovo and Republic of Macedonia) and Dinaric massifs (Montenegro and Serbia). In: Ivetić V., Stanković D. (eds.) Proceedings: International conference Reforestation Challenges. 03-06 June 2015, Belgrade, Serbia. Reforesta. pp. 260-265.

Abstract: When selecting Bosnian pine individuals for the forestation of high mountain areas, in order to preserve genetic diversity, it is necessary to also take into consideration the variability of terpenic composition, since some terpenes have previously been proven to be under genetic control. In two-year-old Bosnian pine needles, it was noticed that populations from the Scardo-Pindic massif (Mt. Ošljak, Serbia-Kosovo and Mt. Galičica, Republic of Macedonia) on average have considerably more germacrene D (27%) than the populations of the Dinaric massif (15.3%, Mt. Lovćen, Mt. Zeletin and Mt. Bjelasica, Montenegro and Mt. Revuša, Serbia). Discriminant analysis (DA) of 7 terpenes has ascertained a clear differentiation of populations from Montenegro, Serbia and Macedonia. The analysis of the terpenic profile at the population level established at least 4 chemotypes in the Bosnian pine: chemotype A: with predominant germacrene D (Ošljak), chemotype B: limonene (Galičica, Zeletin and Bjelasica), chemotype B/A: limonene and germacrene D (Revuša) and chemotype B/C: limonene and α -pinene (Lovćen).

Keywords: Bosnian pine, essential oil, limonene, germacrene D, α -pinene.

INTRODUCTION

The existence of different chemotypes in pine species has already been investigated before, e.g. within genera *Cupressus* (Gallis et al. 2007), *Pinus* (Arrabal et al. 2012), *Juniperus* (Rajčević et al. 2015), etc. Population variability of Bosnian pine terpenes on the territory of Montenegro and Serbia (and partly Macedonia) has already been studied (Nikolić et al. 2007, 2011, 2015, Bojović et al. 2011). The results yielded by the comparative research (Nikolić et al. 2015) point to a partial divergence between the populations of the Dinaric and Scardo-Pindic massifs. This paper will be analysing the basic types of chemical profiles of Bosnian pine and their impact on population differentiation.

MATERIAL AND METHODS

We analysed the composition of the chief terpenic components of two-year-old Bosnian pine needles in populations of the Dinaric: Lovćen (30 trees), Zeletin (30 trees), Bjelasica (30 trees) (Montenegro) and Revuša (30 trees) (southwest Serbia) and the Scardo-Pindic massif: Ošljak (16 trees) (Serbia - Kosovo) and Galičica (8 trees) (Macedonia). The process of extraction and chemical analysis of the terpenes has already been described in detail (Nikolić et al. 2007, etc.). The populations were classified into distinct chemotypes according to their dominant components. Discriminant analyses (DA) was used to ascertain whether there is any divergence between the populations from different geographic areas and mountain ranges and whether the divergence coincides with the chemotypes discovered.

RESULTS

The average terpenic profile of all 6 Bosnian pine populations analysed is dominated by limonene (26.5%), with germacrene D (19.2%), α -pinene (16.7%), β -caryophyllene (8.9%) and β -pinene (5.4%) among the more abundant components. δ -3-Carene and other less abundant components make up about 23.4% of the essential oil (Figure 1a). However, what is also obvious are the biggest differences between the Bosnian pines of the Scardo-Pindic and Dinaric mountain ranges in the average amount of germacrene D (27% and 15%, respectively) (Figures 1b and 1c), as well as in the abundance of β -pinene (4%, Bosnian pines of the Scardo-Pindic massif), and β -caryophyllene (10.3%) and δ -3-carene (2%) (Bosnian pines of the Dinaric massif).

The differences are even more pronounced if only the most abundant components are taken into consideration (Figure 2a), disregarding the rest of the components. In the profile of the most abundant components limonene (34%) is dominant, followed by germacrene D (25%), α -pinene (21%), β -caryophyllene (11%), β -pinene (7%) and δ -3-carene (2%). Bosnian pines of the Scardo-Pindic massif have almost equal amounts of limonene and germacrene D (35% and 34%, respectively), while α -pinene comes in third (22%) (Figure 2a). However, Bosnian pines of the Dinaric massif have a much higher amount of limonene (37%), and almost equal amounts of α -pinene and germacrene D (23% and 22%, resp.) (Figure 2c). The accompanying graphs show that the average terpenic profile of Bosnian pines of the Scardo-Pindic massif is as follows: limonene=germacrene D> α -pinene>> β -caryophyllene= β -pinene, and of Bosnian pines of the Dinaric massif: limonene>> α -pinene=germacrene D> β -caryophyllene> δ -3-carene, where, according to Petrakis et al. (2001), =, > and >> represent relative differences of 0.1-1%, 1.1-5.0% and 5.0-15.0%, respectively. Hence, apart from the different ranking of the 3 main components, Bosnian pines from the Scardo-Pindic massif are characterized by a significant amount of β -pinene (Fig 2b), while the ones from the Dinaric massif have more significant amounts of δ -3-carene and β -caryophyllene (Figure 2c).

The differences between these two mountain ranges are even more pronounced when comparing individual populations. Population I (Ošljak) is characterized by dominant germacrene D (39%) and a fair amount of limonene (30%) compared to α -pinene (16%)

(Figure 2b/1). Population Galičica (II) is dominated by limonene (36%), while α -pinene and germacrene D appear in equal amounts (25% each) (Figure 2b/2). Population Lovćen (III) is dominated by limonene (33%), while α -pinene and germacrene D are less abundant (27% and 20%, resp.) (Figure 2c/1). Zeletin (IV) and Bjelasica (V) (Figures 2c/2 and 2c/3) are similar in the ranking of the most abundant components (limonene, α -pinene, germacrene D) both to each other and to population Galičica, but differ in the lower amount of germacrene D (19% and 15%, resp.) and a higher amount of β -caryophyllene (16% and 15%, resp.). Population Revuša (VI) has approximately equal amounts of limonene and germacrene D (31% and 27%, resp.), while the amount of α -pinene is low (only 14%) (Figure 2c/4). What distinguishes this population from the rest is also a significant amount of δ -3-carene (11%), and a small amount of β -pinene (only 5%).

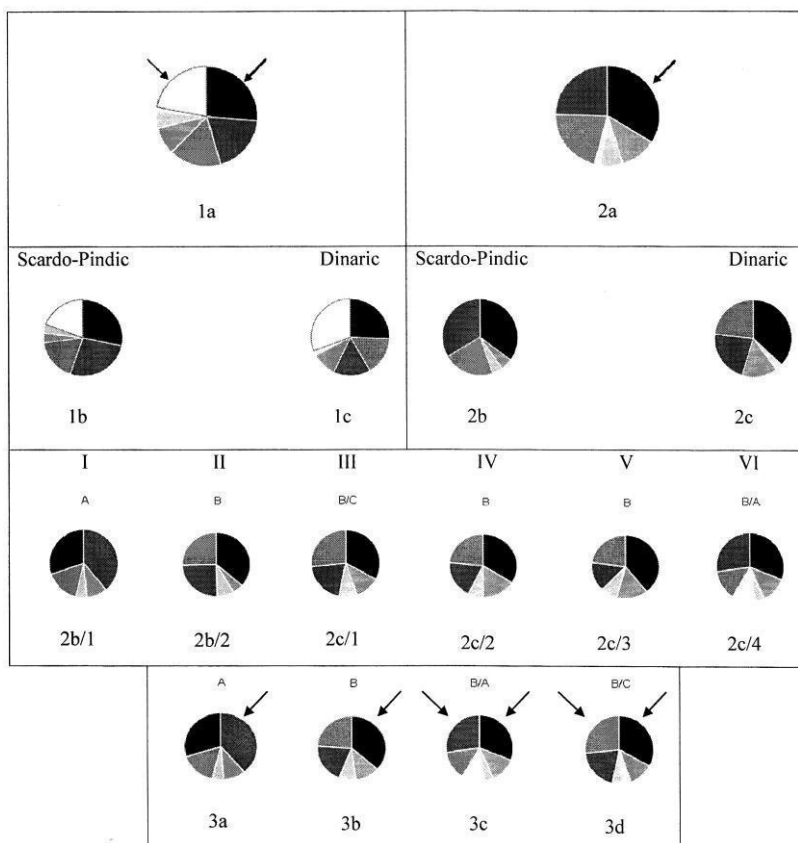

Figures 1, 2 and 3: Abundance of limonene, germacrene D, α -pinene, β -caryophyllene, β -pinene, δ -3-carene, and other compounds. Average terpenic profiles of all (1a) and the most abundant compounds (2a). Average terpenic profiles of Scardo-Pindic (1b, 2b) and Dinaric (1c, 2c) mountains. Terpenic profiles of populations: I – Ošljak (2b/1), II – Galičica (2b/2), III – Lovćen (2c/1), IV – Zeletin (2c/2), V – Bjelasica (2c/3), and VI – Revuša (2c/4). Four main chemotypes: A (3a), B (3b), B/A (3c), and B/C (3d).

If germacrene D is marked as A, a limonene as B, it is safe to conclude that the analysed populations of Bosnian pine have at least 4 chemotypes: *chemotype A* (population Ošljak), dominated by germacrene D (39%) (Fig 3a), *chemotype B* (populations Galičica, Zeletin and Bjelasica), dominated by limonene (37%) (Figure 3b), *chemotype B/A* (population Revuša), dominated by limonene and germacrene D (31% and 27%, resp.) (with a fair abundance of δ -3-carene, 11%) (Fig 3c) and *chemotype B/C* (population Lovćen) dominated by limonene and α -pinene (33% and 27%, resp.) (Figure 3d).

Comparing the mountain ranges, the Bosnian pines of the Scardo-Pindic massif can be said to exhibit two chemotypes: chemotype A (on the border of Kosovo and Macedonia) and chemotype B (in Macedonia), while the Dinaric Bosnian pines have three chemotypes: chemotypes B/C, B/A (at the edges of the massif, in Montenegro and Serbia, resp.) and B (in the middle, Montenegro) (Figure 4).

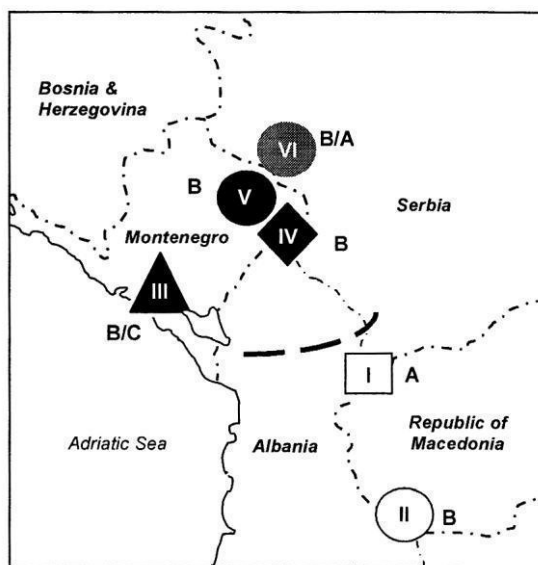

Figure 4. Distribution of Bosnian pine chemotypes (A, B, B/C, and B/A).
--- : border between Dinaric (above) and Scardo-Pindic (below) massifs. For names of populations I-VI see caption of Figures 1, 2 and 3 and legend of Figure 5.

Discriminant analysis (DA) was performed based on 7 selected terpene components (β -myrcene, limonene, β -elemene, β -caryophyllene, α -humulene, δ -cadinene and germacrene-D-4-ol) (Figure 5). The divergence between populations did not coincide with the separated chemotypes, but it was noted to coincide with the amounts of germacrene D and geographic position of the populations: abundant, 27-39%, populations in Serbia (Revuša and Ošljak), medium abundance, about 25%, Macedonian population (Galičica) and low abundance, less than 20%, Montenegrin populations (Lovćen, Zeletin and Bjelasica) (Figures 2b/1–2c/4). Furthermore, according to the analysis of the 7 components, population Revuša is closer to the Scardo-Pindic than the Dinaric massif

(which it belongs to geographically). Therefore, DA suggests the existence of two population groups based on the abundance of germacrene D (up to 25 % and more than 25%), and the populations' belonging to a certain mountain range is not crucial (due to population Revuša).

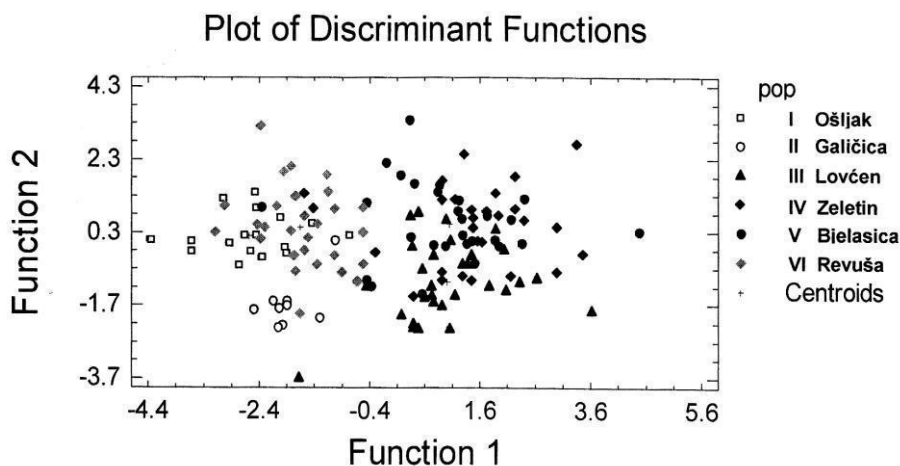

Figure 5. Plot obtained by discriminant analysis of seven selected terpene compounds from Bosnian pine populations I-VI (144 trees).

DISCUSSION

The investigation of *Cupressus sempervirens* oleoresin on Crete alone, based on the abundance of α -pinene, δ -3-carene, α -terpinyl acetate and cedrol, on a relatively small geographic area, registered as many as 5 chemotypes (Gallis et al. 2007). In *Pinus pinaster* from Spain, two chemotypes were demarcated based on resin acids and terpene in the needles (Arrabal et al. 2012). Investigating the terpene variability in the needles of *Juniperus deltoides* along the East Adriatic coast, it was concluded that it has at least 3 chemotypes: 1. α -pinene type, 2. limonene type and 3. limonene/ α -pinene type (Rajčević et al. 2015).

Previous research (Nikolić et al. 2015) has ascertained by PCA analysis (of the same terpene components as the DA) partial divergence between Bosnian pines growing on the Scardo-Pindic and the Dinaric massifs. In it, the Serbian population was represented by 7 trees from a wider geographical area. Instead of them, this research used population Revuša, which, according to our investigation, came in half-way between the Bosnian pines of the Scardo-Pindic range (which show a clear divergence among themselves) and the Bosnian pines of the Dinaric range of Montenegrin provenance.

CONCLUSIONS

Bosnian pines of the Scardo-Pindic range belong to chemotypes A (Ošljak) and B (Galičica), while the Bosnian pines of the Dinaric range belong to chemotypes B (Zeletin and Bjelasica), B/A (Revuša) and B/C (Lovćen). The investigations confirm the almost complete divergence between the Bosnian pines of the Scardo-Pindic and Dinaric massif (except for population Revuša), i.e. divergence of Bosnian pines from Montenegro, Serbia and Macedonia. It leads to the conclusion that the tectonic disturbances on the collision point of the Dinaric and Scardo-Pindic massif and ancient climate change caused the divergence of Bosnian pines in Montenegro (dominated by limonene) from the Bosnian pines in southwest Serbia, Revuša (with copious amounts of germacrene D), even though they belong to the same massif (Dinaric).

Acknowledgments: This work is part of two research projects (173029 and 173021) supported by the Ministry of Education, Science, and Technological Development of the Republic of Serbia.

REFERENCES

- Arrabal C., Garcia-Vallejo M.C., Cadahia E., Cortijo M., de Simon B.F. (2012). Characterization of two chemotypes of *Pinus pinaster* by their terpene and acid patterns in needles. *Plant Systematics & Evolution* 298: 511–522.
- Bojović S., Nikolić B., Ristić M., Orlović S., Veselinović M., Rakonjac Lj., Dražić D. (2011). Variability in chemical composition and abundance of the rare tertiary relict *Pinus heldreichii* in Serbia. *Chemistry & Biodiversity* 8: 1754-1765.
- Gallis A.T., Doulis A.G., Papageorgiou A.C. (2007). Variability of cortex terpene composition in *Cupressus sempervirens* L. provenances grown in Crete, Greece. *Silvae Genetica* 56: 294-299.
- Nikolić B., Ristić M., Bojović S., Marin P.D. (2007). Variability of the needle essential oils of *Pinus heldreichii* from different populations in Montenegro and Serbia. *Chemistry & Biodiversity* 4: 905-916.
- Nikolić B., Ristić M., Tešević V., Marin P.D., Bojović S. (2011). Terpene chemodiversity of relict conifers *Picea omorika*, *Pinus heldreichii*, and *Pinus peuce*, endemic to Balkan. *Chemistry & Biodiversity* 8: 2247-2260.
- Nikolić B., Ristić M., Bojović S., Krivošej Z., Matevski V., Marin P.D. (2015). Population variability of essential oils of *Pinus heldreichii* from the Scardo-Pindic mountains Ošljak and Galičica. *Chemistry & Biodiversity* 12: 295-308.
- Petrakis P. V., Tsitsimpikou C., Tzakou O., Couladis M., Vagias C., Roussis V. (2001). Needle volatiles from five *Pinus* species growing in Greece. *Flavour and Fragrance Journal* 16: 249 - 252.
- Rajčević N., Janačković P., Dodoš T., Tešević V., Marin P.D. (2015). Essential-oil variability of *Juniperus deltoides* R. P. Adams along the East Adriatic Coast – How many chemotypes are there? *Chemistry & Biodiversity* 12: 82-95.

INTRA-POPULATION GENETIC DIVERSITY OF BEECH IN NORTHEAST SERBIA ASSESSED BY MICROSATELLITE MARKERS

Nonić Marina^{*}, Heinze Berthold, Mengl Michael, Devetaković Jovana, Slunsky Renate

*corresponding author: marina.nonic@sfb.bg.ac.rs

Nonić M., Heinze B., Mengl M., Devetaković J., Slunsky R. (2015). Intra-population genetic diversity of beech in northeast Serbia assessed by microsatellite markers. In: Ivetić V., Stanković D. (eds.) Proceedings: International conference Reforestation Challenges. 03-06 June 2015, Belgrade, Serbia. Reforesta. pp. 266-275.

Abstract: Numerous studies demonstrate the usefulness of microsatellite markers in the field of population genetics of various forest tree species, among others, different beech species. The genetic structure of the Moesian beech (*Fagus moesiaca* /Domin, Maly/Czeczott) population in northeast Serbia (Boljetinska reka) was studied in a sample of 45 genotypes, based on microsatellite molecular markers. Five primer pairs of microsatellite loci (csolfagus_19, csolfagus_31, mfc5, sfc_0036 and DE576_A_0) were used for analysis of intra-population genetic diversity. Undamaged dormant buds were harvested from the sampled beech individuals (aged between 3 and 5 years) for DNA isolation and PCR amplification. Fragment length sizing and allele determination of the obtained PCR products were performed using a capillary electrophoresis automatic sequencer. GenAEX 6.5 (*Genetic Analysis in Excel*) software was used to assess genetic diversity. Observed and expected heterozygosity in the studied population were high (mean $H_o = 0.738$ and mean $H_e = 0.837$), which indicates a considerable amount of genetic diversity within the population.

Keywords: genetic diversity, microsatellite markers, beech, population

INTRODUCTION

Beech is a dominant forest species in the growing stock of Serbia - 50.4% per volume, with wide range of vertical (from 40 m to 2100 m) and horizontal distribution. It grows in various structural forms, pure and mixed forest communities, both with broadleaves and with conifers, and is characterized by a high variability of numerous traits (Šijačić-Nikolić *et al.* 2010). According to Jovanović and Cvjetičanin (2005), the genus *Fagus* L. in Serbia includes three beech species: European beech (*Fagus sylvatica* L.), Oriental beech (*Fagus orientalis* Lipsky) and Balkan beech - *Fagus moesiaca* (Domin, Maly) Czeczott, which is the most widely distributed, but there is no consensus regarding the taxonomical status of beech from the Balkan Peninsula (Ivetić 2009).

Genetic studies of beech have been performed in different populations over a wide range of the species distribution. Genetic diversity of beech species and genetic structures of beech populations were subjects of numerous research in different countries: Italy (Leonardi and Menozzi 1995, 1996, Emilliani *et al.* 2004, Vettori *et al.* 2004,

Figliuolo 2011, 2014), Germany (Vornam et al. 2004, Buiteveld et al. 2007), Slovenia (Brus et al. 1999, Božić and Kutnar 2012, Božić et al. 2013); Balkan countries (Gömöry et al. 1999), Bosnia and Herzegovina (Ballian et al. 2012, 2013), Serbia (Ivetić et al. 2008, 2012, Ivetić 2009), etc.

Numerous studies demonstrated the usefulness of microsatellite markers (Simple Sequence Repeats - SSRs) in the field of population genetics of beech species, but there were not yet many microsatellite studies of beech in Serbia. Microsatellite markers are among the most informative and most commonly used molecular markers in population genetics, due to their high mutation rate. There are many advantages of using microsatellites in genetic studies – generally, they show a large number of alleles at a given locus, co-dominant inheritance, they can be found in the chloroplast and mitochondrial genomes and they can be efficiently analyzed from very small amounts of plant tissue, etc. (Lefort et al. 1999, Maksimović et al. 2014).

The aim of this research was to determine intra-population genetic diversity of one beech (*Fagus moesiaca* /Domin, Maly/ Czezcott) population in northeast Serbia, at the molecular-genetic level, by microsatellite markers.

MATERIAL AND METHODS

The plant material was collected from one natural population of Balkan beech (*Fagus moesiaca* /Domin, Maly/ Czezcott) in northeast Serbia - Boljetinska reka (Figure 1). The geographical location of this population is shown in Figure 1, its latitude (N) is 44° 27' 42", longitude (E) 21° 59' 5" and altitude is 670 m.



Figure 1. Map of sampled beech population in Serbia.

The samples of 45 juvenile beech plants (aged between 3 and 5 years) from the population were selected. Undamaged dormant buds were harvested from each individual and were dried and preserved in plastic zip lock bags with silica gel until DNA isolation.

The laboratory work was done at the Federal Research and Training Centre for Forests, Natural Hazards and Landscape - Department of Genetics, Unit of Genome Research in Vienna, Austria.

DNA was extracted from approximately 60 mg of dried plant material from each sample. The TissueLyser (Qiagen) was used for grinding the plant material to a fine powder, and DNA was extracted using the Invisorb Spin Plant Mini Kit (STRATEC Molecular GmbH, Germany) and following the manufacturer's instructions. Concentration and purity of DNA were determined by electrophoresis on an agarose gel and spectrophotometrically. The PCR (polymerase chain reaction) was performed using a Programmable Thermal Controller PTC-100 (MJ Research), and the amplification products were resolved on 1.5% agarose gels.

In total, five pairs of microsatellite markers (csolfagus_31, csolfagus_19, sfc_0036, DE576_A_0 and mfc5), the description of which is given in Table 1, were used for the analysis of intra-population genetic diversity in the Serbian beech population. SSR loci csolfagus_31 and csolfagus_19, according to Lefèvre *et al.* (2012) "...had been developed by G. G. Vendramin (personal communication) for *Fagus sylvatica*", locus sfc_0036 had been developed by Asuka *et al.* (2004) for *Fagus crenata* Blume, DE576_A_0 for *Fagus sylvatica* L. by Lefèvre *et al.* (2012) and mfc5 by Tanaka *et al.* (1999), for *Fagus crenata* Blume.

These markers had been used in genetic studies of beech species by different authors: locus mfc5 by Tanaka *et al.* (1999), Vornam *et al.* (2004), Buiteveld *et al.* (2007), Chybicki *et al.* (2009), Hiraoka and Tomaru (2009), Figliuolo (2011, 2014) and Hasenkamp *et al.* (2011); locus sfc_0036 by Asuka *et al.* (2004), Chybicki *et al.* (2009), Hiraoka and Tomaru (2009), Kobayashi *et al.* (2009); while Lefèvre *et al.* 2012 and Westergren *et al.* 2015 used four of the five selected microsatellites (csolfagus_19, csolfagus_31, sfc_0036, DE576_A_0).

Table 1. Primer sequences and characteristics of five polymorphic microsatellite markers used in this study.

SSR locus	Forward/Reverse primer sequences (5'-3')	Repeat sequence	No. of alleles	Allele size range (bp)	Reference
csolfagus_31	F: TCTATTGACACAAGAATAAGAACACC R: CTTGGCAAGAAAAGGGGATT	(AG) ₁₂	9	104-126	Lefèvre <i>et al.</i> (2012)
csolfagus_19	F: TGCCCATGAGGTTTGTATCA R: GCCGAATAACCCAGAAAACA	(TC) ₁₃	10	154-182	Lefèvre <i>et al.</i> (2012)
sfc_0036	F: CATGCTTGACTGACTGTAAGTTC R: TCCAGGCCTAAAAACATTTATAG	(TC) ₂₃	17	96-142	Asuka <i>et al.</i> (2004)
DE576_A_0	F: TCTCCTTAGATCCACAATCACA R: AGCTCTTCATTGCTCAGAACG	(CAA) ₁₀	7	211-232	Lefèvre <i>et al.</i> (2012)
mfc5	F: ACTGGGACAAAAAACAAAA R: GAAGGACCAAGGCACATAAA	(AG) ₁₀	21	277-329	Tanaka <i>et al.</i> (1999)

Fragment length sizing and allele determination were performed using the capillary electrophoresis automatic sequencer CEQ™ 8000 Genetic Analyzer System (Beckman Coulter).

Data analysis of the resulting electropherograms was carried out using the CEQ 8000 Analysis Software (Beckman Coulter), while GenAlEx 6.5 (Genetic Analysis in Excel) Software was used for further analyses.

The following parameters were determined for each microsatellite locus: number of total alleles per locus (N_a), number of effective alleles (N_e), observed heterozygosity (H_o), expected heterozygosity (H_e) and fixation index (F).

The same GenAlEx Software was used to calculate: allele frequency, a significance test of deviation from Hardy-Weinberg equilibrium (HW), and pairwise individual-by-individual ($N \times N$) genetic distance matrix, calculated for codominant data by Genetic Distance (Codom-Genotypic) option (Peakall and Smouse 2012).

RESULTS AND DISCUSSION

Levels of genetic diversity in the analysed population Boljetinska reka are presented in Table 2. The analysis of five microsatellite loci has revealed 70 alleles in total, in average 14 alleles per each locus, but with a wide range from 8 (loci sfc0036 and DE576_A_0) to 26 alleles (locus mfc5). The locus mfc5 was the most polymorphic. Number of effective alleles per locus (N_e) ranged from 4.341 (locus sfc0036) to 14.063 (locus mfc5), on average 7.301 per SSR locus.

Mean values of observed (H_o) and expected heterozygosity (H_e) in the studied population are quite high (average H_o value over all five loci is 0.738, while the H_e value was higher, 0.837), Table 2. Comparing these heterozygosities, it can be noted that the values of observed heterozygosity are lower than expected heterozygosity, which is reflected in a positive value of the fixation index (average $F = 0.117$) and indicates a certain amount of inbreeding in the population, as typically found in young material (seedlings) when comparing to older trees (Figliuolo 2011).

Table 2. Levels of genetic diversity in the analyzed beech population in Serbia.

SSR locus	N	N_a	N_e	H_o	H_e	F
csolfagus31	45	10	5.938	0.822	0.832	0.011
csolfagus19	45	18	7.377	0.800	0.864	0.075
sfc0036	45	8	4.341	0.667	0.770	0.134
DE576_A_0	45	8	4.787	0.667	0.791	0.157
mfc5	45	26	14.063	0.733	0.929	0.211
Mean	45	14.000	7.301	0.738	0.837	0.117

Legend: N - number of individuals; N_a - mean number of total alleles; N_e - mean number of effective alleles; H_o - observed heterozygosity; H_e - expected heterozygosity; F - fixation index/inbreeding coefficient

The frequency of detected alleles at the loci is not evenly distributed, thus some alleles contribute more towards the total variability of the specific loci, in contrast to the other alleles, which represent a negligible percentage. The allele frequencies of analyzed SSR loci are shown in Table 3.

PROCEEDINGS
 International Conference **REFORESTATION CHALLENGES**
 03-06 June 2015, Belgrade, Serbia

The length of base pairs (bp) were in the range from 98 (csolfagus31 and sfc0036) to 331 bp (mfc5), depending on the used locus. The maximum frequency was detected at the locus sfc0036, where an allele with the size of 98 bp comprised 41% of all alleles. In comparison to the other alleles, an allele with the length of 231 bp, at the locus DE576_A_0, also had a high frequency (32%), which is in accordance with the minimum number of alleles detected at these two loci - only eight alleles.

On the other hand, at the locus mfc5, 11 of the detected 26 alleles represented 1% of frequency, in accordance with the large number of alleles per this locus. There are, also, some alleles with such low frequency (1%) at other loci, but in a significantly smaller number. In no case they are regular or "smooth", there are always clusters of "preferred" lengths.

Table 3. Allele frequency spectra of SSR loci in population Boljetinska reka.

SSR locus									
csolfagus31		csolfagus19		sfc0036		DE576_A_0		mfc5	
Allele	%	Allele	%	Allele	%	Allele	%	Allele	%
98	2	154	1	98	41	216	16	180	1
104	26	157	1	100	10	219	2	274	1
106	1	159	1	102	6	221	1	280	1
108	7	161	2	104	6	222	21	282	10
110	7	162	1	106	13	225	14	284	10
112	12	163	10	108	14	230	13	286	8
114	2	165	11	110	8	231	32	290	1
116	21	167	4	112	2	234	1	292	3
122	18	169	3					294	2
126	4	171	28					298	1
		173	6					300	7
		175	4					302	2
		177	3					303	7
		179	2					304	7
		181	16					305	1
		182	2					307	2
		183	2					309	13
		185	1					310	1
								311	1
								313	2
								317	9
								319	1
								325	3
								327	1
								329	2
								331	1

The genetic distances between all 45 beech individuals (N01-N45) are presented in Table 4. The obtained results show that the smallest genetic distance (9) was found between 12 pairs of individuals, which indicate those individuals as genetically more similar in comparison with four pairs of individuals, between which the highest genetic

PROCEEDINGS
 International Conference **REFORESTATION CHALLENGES**
 03-06 June 2015, Belgrade, Serbia

distance (17) was found. Beech individual N39 was genetically most distant from individuals N09, N17, N18 and N38.

Taking into account all distances in Table 4, it is obvious that there are more individuals between which genetic distances are relatively small (<15), compared to those with higher values of genetic distances (>15). Groups with low distance among the members could represent related seedling, from the same mother or father trees.

Table 4. The genetic distances between the selected beech trees.

The results of the test for significant deviations from Hardy-Weinberg (HW) equilibrium per each locus are presented in Table 5. The probability of Chi-Square values for loci *csolfagus19* and *sfc0036* was less than 0.01 ($0 < P < 0.01$), which means that the results for these loci were statistically significant, so they deviate from the expected equilibrium. It is obvious that the P-values for other three loci (*csolfagus31*, *DE576_A_0* and *mfc5*) were higher than 0.05, thus these results were not statistically significant.

Table 5. Significance deviation test from Hardy-Weinberg equilibrium per each locus.

SSR loci	DF	ChiSq	P	Signif.
csolfagus31	45	39.775	0.692	ns
csolfagus19	153	199.186	0.007	**
sfc0036	28	51.943	0.004	**
DE576_A_0	28	32.164	0.268	ns
mfc5	325	323.885	0.507	ns

Legend: ns=not significant, * $P < 0.05$, ** $P < 0.01$, *** $P < 0.001$

In comparison with literature data, obtained by microsatellites for the beech species, the results presented in this study are mainly within the range of those obtained

in other European countries. Number of alleles per locus in this study is in line with the numbers obtained in other countries - from 4 to 30 alleles per locus. In Italy, Figliuolo found 5-30 (an average of 17) alleles per locus in aged beech individuals, while an average of 9.7 alleles per locus was found in his study with both old plants and plants aged between 3 and 10 years (Figliuolo 2011, 2014). In research conducted by Koch et al. (2010) an average of 13.8 alleles per locus detected in one beech population located in Ludington (Michigan).

Vornam et al. (2004) in Germany, Buiteveld et al. (2007) in five European countries and Chybicki et al. (2009) in Poland, who analyzed adult beech trees, noted that locus *mfc5* was the most polymorphic (with 21, 23 and 22 alleles per locus), as well as in this research. In each study, different numbers of trees, in different constellations, were analyzed.

The mean value of expected heterozygosity, obtained by microsatellites in this research ($He = 0.837$) indicates a considerable amount of genetic diversity within the studied population. In numerous studies with European beech populations (Comps et al. 1990; Leonardi and Menozzi 1995, 1996; Belletti and Lanteri 1996; Sander et al. 2000, 2001; Ballian et al. 2012, 2013; Leonardi et al. 2012; Pluess and Weber 2012) and Oriental beech populations (Salehi Shanjani et al. 2002, 2011a, 2011b), more than 90% of total genetic diversity were ascribed to allele variance between individuals in a given population (intra-population diversity) and less than 10% of genetic diversity to differentiation between populations (inter-population diversity).

Vornam et al. (2004), who studied 99 adult trees from one European beech population in Germany, found that mean Ho was 0.572, which is lower than the value obtained in the Serbian population, while her mean He (0.765) was more similar to the results presented in this research. Koch et al. (2010), in the research conducted with mature trees and seedlings (progeny) of one beech population in USA-Michigan, using six microsatellite markers, found an average He of 0.767 and Ho of 0.784. Comparable values were obtained with microsatellites by Chybicki et al. (2009) in Poland, analyzing mature trees from two European beech populations; average genetic diversity was up to 0.870 in both populations. Similar, but slightly higher values were obtained in Poland, by Kraj and Sztorc (2009), who used microsatellites to describe the genetic structure and variability of early ($He = 0.865$), intermediate ($He = 0.855$) and late ($He = 0.869$) phenological forms of European beech in three populations (15-20 years-old). In a microsatellite study of ten stands with adult beech trees, located in five European countries (Austria, France, Germany, Italy, Netherlands), Buiteveld et al. (2007) obtained similar He values, ranging between 0.749 and 0.868.

CONCLUSIONS

Five analyzed SSR primer pairs showed a significant level of intra-population genetic diversity of beech in the studied population Boljetinska reka, from northeast Serbia. Using those primers between 8 and 26 (in average 14) alleles per locus have been detected, which was in line with results from other microsatellite research in beech populations.

Deviation of loci csolfagus19 and sfc0036 from Hardy-Weinberg equilibrium were statistically significant (in the range $0 < P < 0.01$), hence, the null hypothesis could be rejected, which means that there is no random mating within the studied population. Deviations from Hardy-Weinberg equilibrium for loci csolfagus31, DE576_A_0 and mfc5 were not statistically significant ($0.05 < P < 1$), therefore, the null hypothesis that in the studied population random mating is present could be accepted. The obtained results from significance deviation test from HW equilibrium should be checked on a larger number of individuals and with more markers, in order to determine whether random mating is present in population or not.

The main characteristic of gene pool of beech in Serbia, in comparison of previous results and this single example, may be a variability of different morphological, physiological as well as genetic traits. The research of genetic variability should be done on the basis of a larger number of beech populations throughout the country. Microsatellites used in this research could be used in intra- and inter-population studies, in order to get familiar with the genetic structure of different populations and genetic diversity between populations from different parts of Serbia.

Acknowledgements: Financial support by The Transnational access to research infrastructures activity in The 7th Framework Programme of the EC under the TREES4FUTURE Project (No. 284181) for conducting the research is gratefully acknowledged. Also, the Federal Research and Training Centre for Forests, Natural Hazards and Landscape (Department of Genetics - Unit of Genome Research in Vienna, Austria) is acknowledged by Marina Nonić for hosting, with special thanks to host Dr. Berthold Heinze and his colleagues for scientific, technical and logistical support.

REFERENCES

- Asuka Y., Tani N., Tsumura Y., Tomaru N. (2004). Development and characterization of microsatellite markers for *Fagus crenata* Blume. *Molecular Ecology Notes* 4: 101–103.
- Ballian D., Bogunić F., Mujezinović O., Kajba D. (2012). Genetic differentiation of European beech (*Fagus sylvatica* L.) in Bosnia and Herzegovina. *Šumarski list* 11–12 (2012): 587–595.
- Ballian D., Isajev V., Daničić V., Cvjetković B., Bogunić F., Mataruga M. (2013). Genetic differentiation in seed stands of European beech (*Fagus sylvatica* L.) in part of Bosnia and Herzegovina. *Genetika*, Vol 45, No. 3: 895-906.
- Belletti P., Lanteri S. (1996). Allozyme variation among European beech (*Fagus sylvatica* L.) stands in Piedmont, north western Italy. *Silvae Genetica* 45 (1): 33-37.
- Božić G., Ivanković M., Kutnar L. (2013). Genetic structure of European beech (*Fagus sylvatica* L.) seed stands from different forest sites of Gorjanci Mountains as revealed by isoenzymes. *Šumarski list*, 1–2 (2013): 25–32.
- Božić G., Kutnar L. (2012). Genetic variability of two *Fagus sylvatica* (L.) populations in the south-western edge of the Pannonian Plain. *Acta Silv. Hung.*, Vol. 8: 75-86.
- Brus R., Horvat-Marolt S., Paule L., Gömöry D. (1999). Genetska variabilnost bukve (*Fagus sylvatica* L.) v Sloveniji [Genetic variation of the beech (*Fagus sylvatica* L.) in Slovenia]. *Zbornik gozdarstva in lesarstva*, 60: 85-106.
- Buiteveld J., Vendramin G.G., Leonardi S., Kamen K., Geburek T. (2007). Genetic diversity and differentiation in European beech (*Fagus sylvatica* L.) stands varying in management history. *For. Ecol. Manag.* 247: 98-106.

- Chybicki I., Trojankiewicz M., Oleksa A., Działuk A., Burczyk J. (2009). Isolation-by-distance within naturally established populations of European beech (*Fagus sylvatica*). *Botany* 87: 791-798.
- Comps B., Thiébaud B., Paule L., Merzeau D., Letouzey J. (1990). Allozymic variability in beech woods (*Fagus sylvatica* L.) over Central Europe: spatial differentiation among and within populations. *Heredity* 65: 407-417.
- Emiliani G., Paffeti D., Vettori C., Giannini R. (2004). Geographic distribution of genetic variability of *Fagus sylvatica* L. in southern Italian populations. *Forest Genetics* 11 (2-3): 231-237.
- Figliuolo G. (2011). Landscape genetics of *Fagus sylvatica* in one of its glacial refuge areas. In: *Wild plants: identification, uses and conservation*, Davis, R.E. (ed.). Nova Science Publishers, Inc., New York: 149-177.
- Figliuolo G. (2014). Addressing biodiversity conservation methods with *Fagus sylvatica* genetic indicators. *Open Journal of Genetics*, 4: 166-174.
- Gömöry D., Paule L., Brus R., Zhelev P., Tomović Z., Gračan J. (1999). Genetic differentiation and phylogeny of beech on the Balkan Peninsula. *J. Evol. Biol.* 12: 746-754.
- Hasenkamp N., Ziegenhagen B., Mengel C., Schulze L., Schmitt H.P., Liepelt S. (2011). Towards a DNA marker assisted seed source identification: a pilot study in European beech (*Fagus sylvatica* L.). *Eur. J. Forest Res.* 130: 513-519.
- Hiraoka K., Tomaru N. (2009). Genetic divergence in nuclear genomes between populations of *Fagus crenata* along the Japan Sea and Pacific sides of Japan. *J. Plant Res.* 122: 269-282.
- Ivetic V., Isajev V., Mladenović-Drinić S. (2008). "Landscape shape interpolation" for defining spatial pattern of beech genetic diversity in Serbia. *Genetika*, Vol. 40, No. 3: 283-292.
- Ivetic V. (2009). Izdvajanje regiona provenijencija bukve u Srbiji primenom prostorne analize genetičkog diverziteta. Doktorska teza, Univerzitet u Beogradu – Šumarski fakultet [Delineation regions of provenances of beech in Serbia by the spatial analysis of genetic diversity. PhD thesis, University of Belgrade-Faculty of Forestry]. 210 p.
- Ivetic V., Isajev V., Nikolić A., Krstić M., Ristić D., Kostadinović M. (2012). Delineation of beech provenance regions in Serbia by spatial analysis of genetic diversity. *Genetika*, Vol 44, No. 1: 101-108.
- Jovanović B., Cvjetičanin R. (2005). Taxonomy, morphology and distribution of Balkan beech (*Fagus moesiaca* /Domin, Mally/ Czeczott) in Serbia. In: *Beech (Fagus moesiaca /Domin, Mally/ Czeczott) in Serbia*, Stojanović Lj. (ed.). Association of forestry engineers and technicians of Serbia, Faculty of Forestry-University of Belgrade: 75-83.
- Kraj W., Sztorc A. (2009). Genetic structure and variability of phenological forms in the European beech (*Fagus sylvatica* L.). *Ann. For. Sci.* 66, 203: 1-7.
- Kobayashi M., Kitamura K., Kawahara T. (2009). Microsatellite polymorphism of Siebold's beech (*Fagus crenata* Blume) at five National forest reserves in the Oshima Peninsula, southern Hokkaido. *Bulletin of FFPRI*, Vol. 8 No.2 (No.411): 143-148.
- Koch J.L., Carey D.W., Mason M.E. (2010). Use of microsatellite markers in an American beech (*Fagus grandifolia*) population and paternity testing. *Silvae Genetica* 59, 2-3: 62-68.
- Lefèvre S., Wagner S., Petit R.J., Lafontaine G. (2012). Multiplexed microsatellite markers for genetic studies of beech. *Molecular Ecology Resources* 12: 484-491.
- Lefort F., Echt C., Streiff R., Vendramin G.G. (1999). Microsatellite sequences: a new generation of molecular markers for forest genetics, *Forest genetics* 6 (1), 15-20.
- Leonardi S., Menozzi P. (1995). Genetic variability of *Fagus sylvatica* L. in Italy: The role of postglacial recolonization. *Heredity* 75: 35-44.
- Leonardi S., Menozzi P. (1996). Spatial structure of genetic variability in natural stands of *Fagus sylvatica* L. (beech) in Italy. *Heredity* 77: 359-368.

- Leonardi S., Piovani P., Scalfi M., Piotti A., Giannini R., Menozzi P. (2012). Effect of habitat fragmentation on the genetic diversity and structure of peripheral populations of beech in central Italy. *Journal of Heredity* 2012: 103 (3): 408-417.
- Maksimović Z., Čortan D., Ivetić V., Mladenović Drinić S., Šijačić-Nikolić M. (2014). Genetic structure of black poplar (*Populus nigra* L.) population in the area of Great war island - *Genetika*, Vol 46, No. 3, 963-973.
- Peakall R., Smouse P.E. (2012). GenAEx 6.5: genetic analysis in Excel. Population genetic software for teaching and research – an update. *Bioinformatics* 28: 2537-2539.
- Pluess A.R., Weber P. (2012). Drought-adaptation potential in *Fagus sylvatica*: linking moisture availability with genetic diversity and dendrochronology. *PLOS ONE* 7(3) e33636: 1-8.
- Salehi Shanjani P., Paule L., Khavari-Nejad R.A., Gömöry D., Sagheb-Talebi K. (2002). Genetic diversity of Oriental beech (*Fagus orientalis* Lipsky) forests over the Hyrcanian zone. *Forest Genetics* 9(4): 297-308.
- Salehi Shanjani P., Vendramin G.G., Calagari M. (2011a). Altitudinal genetic variations among the *Fagus orientalis* Lipsky populations in Iran. *Iran. J. Biot.* 9 (1): 11-20.
- Salehi Shanjani P., Vendramin G.G., Calagari M. (2011b). Differences in genetic structure among *Fagus orientalis* Lipsky (Oriental beech) populations under different management conditions: implications for *in situ* gene conservation. *Journal of Sciences, Islamic Republic of Iran* 22(1): 5-13.
- Sander T., Koenig S., Rothe G.M., Janssen A., Weisgerber H. (2000). Genetic variation of European beech (*Fagus sylvatica* L.) along an altitudinal transect at mount Vogelsberg in Hesse, Germany. *Mol Ecol.* 9: 1349-1361.
- Sander T., Rothe G.M., Weisgerber H., Janssen A. (2001). Allelic and genotypic variation of 13 European beech (*Fagus sylvatica* L.) populations in Hesse, Germany. *Forest Genetics* 8 (1):13-24.
- Šijačić-Nikolić M., Orlović S., Pilipović A. (2010). Current state of Balkan beech (*Fagus sylvatica* ssp. *sylvatica*) gene pool in the Republic of Serbia. *Communicationes Instituti Forestalis Biohemicae* Vol. 25, Forestry and Game Management Research Institute Strnady: 210-220.
- Tanaka K., Tsumura Y., Tomaru N. (1999). Development and polymorphism of microsatellite markers for *F. crenata* and the closely related species, *F. japonica*. *Theor. Appl. Genet.* 99: 11-15.
- Vettori C., Vendramin G.G., Anzidei M., Pastorelli R., Paffetti D., Giannini R. (2004). Geographic distribution of chloroplast variation in Italian populations of beech (*Fagus sylvatica* L.). *Theor. Appl. Genet.* 109: 1-9.
- Vornam B., Decarli N., Gailing O. (2004). Spatial distribution of genetic variation in a natural beech stand (*Fagus sylvatica* L.) based on microsatellite markers. *Conserv. Genet.* 5: 56-570.
- Westergren M., Božić G., Ferreira A., Kraigher H. (2015). Insignificant effect of management using irregular shelterwood system on the genetic diversity of European beech (*Fagus sylvatica* L.): A case study managed stand and old growth forest in Slovenia. *Forest Ecology and Management* 335: 51-59.

GROWTH ELEMENTS OF ITALIAN ALDER (*ALNUS CORDATA* /LOISEL./ DESF.) TREES - POTENTIALLY APPLICABLE SPECIES IN SERBIA

Bobinac Martin, Andrašev Siniša, Perović Marko, Bauer-Živković Andrijana, Jorgić Đura

*Corresponding author: martin.bobinac@sfb.bg.ac.rs

Bobinac M., Andrašev S., Perović M., Bauer-Živković A., Jorgić Đ. (2015). Growth elements of Italian alder (*Alnus cordata* /Loisel./ Desf.) trees - Potentially applicable species in Serbia. In: Ivetić V., Stanković D. (eds.) Proceedings: International conference Reforestation Challenges. 03-06 June 2015, Belgrade, Serbia. *Reforesta*. pp. 276-281.

Abstract: The paper presents the growth elements of foreign trees species *Alnus cordata* (Loisel) Desf., (Italian alder), (*Betulaceae* /Loisel./ DUBY) in experimental plantation in the area of Erdevik, where the presence of this species in allochthonous dendroflora of Serbia was first recorded.

Based on the measurement of diameter and height of 40 trees at the end of 2014, in the age of 11 years, mean height of trees was 13.2 m and dominant was 14.6 m, mean diameter at breast height was 24.8 cm, and dominant 32.1 cm, mean tree volume was 0.54 m³, and dominant 0.81 m³. The mean height increment of a medium tree was 0.95 m·year⁻¹, and dominant 1.47·year⁻¹. Height and diameter structure of the trees in the plantation is unimodal. Height structure has a strong positive asymmetry, with asymmetry coefficient 0.41, while the diameter structure has less expressed positive asymmetry. Both structures have platykurtic flatness. Variability of height structure is 13.6% and almost twice lower than the variability of diameter structure (22.3%). The degree of slenderness is 38-74, with an average of 54, and is characteristic for planting with no expressed competition among trees for living space.

According to the growth elements of trees in the studied plantation at the age of 2+9 years Italian alder has the characteristics of rapid growth and could represent potentially applicable species in the Serbian area: as fast-growing species in forest plantations for biomass production.

Key words: *Alnus cordata*, growth elements, allochthonous tree species, introduction, Serbia.

INTRODUCTION

The distribution of Italian alder (*Alnus cordata* /Loisel./ Desf.) is limited. It occurs primarily in Italy, in southern Apennines (provinces Basilicata, Calabria and Campania), and it can be found in mountains of northeastern Corsica in France also. It grows at altitudes 200-1600 m (Ducci and Tani 2009). It is cultivated in forest plantations in Italy and France (Mitchell 1979).

Alnus cordata (Loisel.) Desf. is a deciduous tree of medium height, it attains 17-25 m, and up to 28 m under favourable conditions. Italian alder is a fast growing species, it can reach 15 m in 20 years (Mitchell 1979, Shaw et al. 2014). It is less related to wet sites than majority of other species in genus *Alnus* Mill. (*Betulaceae* (Loisel.) Duby), and it grows successfully on limestone (Russel et al. 2007, Shaw et al. 2014). In native stands, wet soils, rich in humus are preferred, but it adapts itself to various soils, and it can be found in dry forests in lowlands or mountains also. Italian alder is a pioneer species and rapidly colonizes forest clearings, formed after cutting of beech and sweet chestnut stands, as well as burned areas, and it forms pure stands in such conditions (Ducci and Tani 2009). It is frosthardy, and it can withstand sea salt in air (Botanica 2004, Shaw et al. 2014).

Its significance reflects in improving soil fertility through symbiotic activity with nitrogen-fixing bacterium *Actinomyces alni* (*Frankia alni*), which is located on roots, and through produced leaf litter, which improves soil humus (Benson et al. 2004). The wood quality is similar to that of hybrid poplars, but the Italian alder wood is heavier, it shrinks to a higher degree, but is more resistant to bending. Wood is not durable in atmospheric conditions, but is durable if it is submerged in water and in that case it is not susceptible to rot. It was used for the foundations of houses and bridges in Venice. Wood is used in carpentry, carving, turnery, as well as furniture production, paneling and plywood production, and as a firewood also (Ducci and Tani 2009, Shaw et al. 2014). In central Italy, Italian alder is massively used for afforestation of poorly drained and wet soils, in agroforestry, and for soil erosion protection in highland areas. It is widely applied recently for protection of plantations of walnut (*Juglans regia* L.), sweet cherry (*Prunus avium* L.), as well as other noble hardwoods (Shaw et al. 2014). It is used also as an ornamental species, since it is one of the most decorative alder species. It differs markedly from other *Alnus* L. species in crown, bark and leaves appearance, as well as by its massive flowers and fruits (Mitchell 1979, Krüssmann 1984).

MATERIAL AND METHOD

Research object

Research was conducted in experimental Italian alder (*Alnus cordata* /Loisel/ Desf.) plot, in Erdevik area, on „Banja“ locality (National park „Fruška Gora“). The plot is established with two years old seedlings (2+0) at the end of the year 2005. This plantation represents the first record of this species in allochthonous dendroflora of Serbia (Bobinac et al. 2015).

Seedlings were produced from seed and donated by nurseryman-collector Đura Jorgić, forestry engineer. Seed originated from one tree in arboretum „Ličine“ in Voćin (Croatia), (Vidaković et al. 1986). Planted seedlings were 1.5-2.0 m high and had high survival rate in the first year. Seedling were planted in line, spaced partially in one, and partially in two rows, with 7 m distance between individuals.

Plot was established in wide valley at the elevation 125 m a.s.l., on the site of grey willow pioneer shrubby plant community (Alliance: *Salicion cinereae* Th. Müller and Görs 1958.). The whole area is characterized by temperate continental climate. According to

the data of the nearest meteorological station in Sremska Mitrovica, for the period 1981-2010, the mean annual air temperature was 11.3°C, mean temperature in January 0.1°C and the lowest recorded temperature was -29.5°C, which is recorded in January 1987. Mean annual precipitation is 614.2 mm, and 60% of that quantity falls in vegetation season. Vegetation season is characterized by low number of frosty days, and during years 2004-2014 the lowest recorded temperatures were in the span -5.6°C to -26.5°C.

Research method

At the end end of year 2014, when seedlings aged 11 years, the girth of 40 trees was measured at breast height, with accuracy 1 mm, as well as total tree height by Vertex III height measurer, with accuracy 0.1 m. Italian alder sample comprised dominant trees, with solitary growth until plantation was eight years old, when crowns began to interlock.

For every measured (diameter and height) and derived (slimness coefficient and volume) growth elements, basic statistical parameters were calculated: arithmetic mean (\bar{x}), standard deviation (s_x), variation coefficient ($c_{v\%}$), minimal (*min*) and maximal (*max*) size, variation height ($v\check{s}$), asymmetry coefficient (α_3) and flatness coefficient (α_4).

Based on stem measurement elements, the average diameter calculated by basal area (d_g), average diameter of 20% thickest trees (dominant diameter) (D_g), average height by Lorey (h_L) and average height of 20% thickest trees (dominant height) (H_g) were calculated. Tree volume was calculated on the basis of volume tables for black alder (*Alnus glutinosa* (L.) Gaertn.) (Mirković 1975). Measured diameters and heights were used for the construction of height curve (model: $h=a \cdot e^{-b/dbh} + 1.3$).

RESULTS AND DISCUSSION

In Italian alder line planting, when trees were 11 years old, the dominant height (H_g) was 14.7 m and it was higher than average height by Lorey (h_L) for 1.5 m or 11.4%. Dominant diameter (D_g) was 32.1 cm and it was higher than average diameter (d_g) for 7.3 cm or 29.4%. Dominant tree volume (v_{Dg}) was 0.81 m³ and it was higher than medium tree volume (v_{dg}) for 0.27 m³ or 50.0% (Table 1).

Table 1. Growth elements of trees and stands on experimental plots.

Species	OP	Age	N	H _g	h _L	D _g	d _g	v _{Dg}	v _{dg}
		year	[trees]	[m]	[m]	[cm]	[cm]	[m ³ ·tree ⁻¹]	[m ³ ·tree ⁻¹]
<i>Italian alder</i>	1	11	40	14,7	13,2	32,1	24,8	0,81	0,54

Height and diameter structure is unimodal (Table 2, Figure 1). Height structure possesses poorly defined positive asymmetry, with asymmetry coefficient 0.414, while diameter structure shows poorly defined positive asymmetry, with asymmetry coefficient 0.119. Both structures have platykurtic flatness. Variability of height structure is two times lower than that of diameter structure, which is a characteristic of fast growing tree species plantations (Andrašev 2008).

Table 2. Height and diameter tree structure.

<i>Growth element</i>	<i>trees</i>	\bar{X}	s_d	c_v	<i>min</i>	<i>max</i>	$v\check{s}$	α_3	α_4
Height – h [m]	40	12,7	1,73	13,6	10,4	16,2	5,8	0,414	2,052
Diameter – $d_{1,3}$ [cm]	40	24,3	5,40	22,3	14,6	34,9	20,2	0,119	2,128

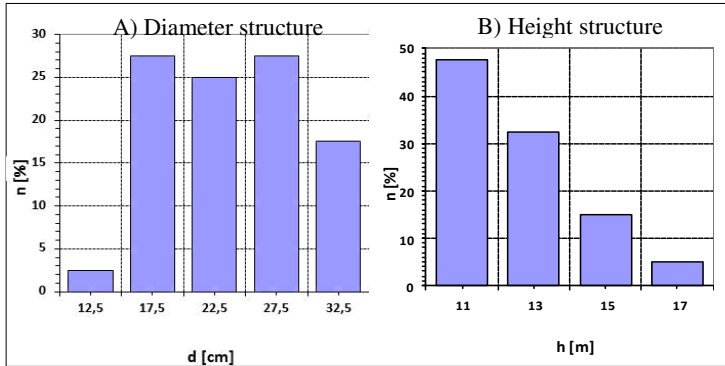

Figure 1. Diameter (left) and height (right) tree structures in plantation.

Trees in line plantation have monopodial growth and intensive ramification, which already starts at the height around 2 m. With 7 m planting distance, the crowns started to interlock in the age of eight years (Picture 1).



Picture 1. Italian alder (*Alnus cordata* /Loisel/ Desf.) trees on grey willow (*Salicion cineræe* Th. Müller and Görs 1958) site in line planting on Erdevik area in the age of 11 years (left) and characteristic stem ramification (right) (Bobinac et al. 2015).

Tree slimness coefficient is 38-74, average value is 54. It has positive asymmetry which points out that trees with slimness coefficient below average dominate (Table 3).

Table 3. Numerical indicators of diameter distribution.

OP	n [tree]	h/d_s	s_d	c_v [%]	h/d_{min}	h/d_{max}	$v\check{s}$	α_3	α_4
OP-1	40	53,8	8,37	15,6	38,5	74,4	36,0	0,371	2,694

Height curve, as a dependence of tree heights from their diameters at the breast height, is modeled by Mihailov function. It can be noticed poorly pronounced twist in height curve, which is a consequence of tree age and poorly pronounced competition for growth space. Parameters of evaluation of height curve models show high level of concordance with the empirical data (Table 4, Figure 2).

Table 4. The model parameters of height curves and their evaluation.

OP	Model: $h=a \cdot e^{-b/d} + 1,3$		s_e [m]	R^2
	a	b		
OP-1	18,0314	10,8472	1,178	0,5468

Legend: h - height, dbh – diameter at breast height, a, b, c – model parameters

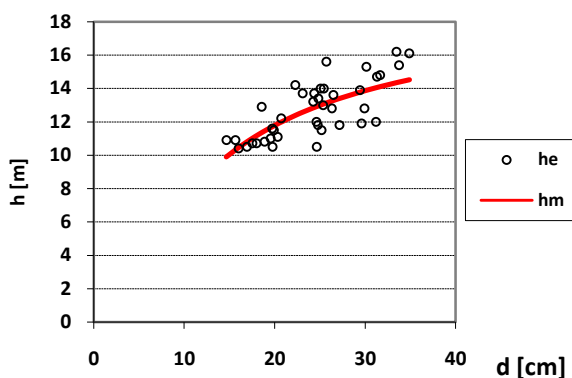

Figure 2. Height curve with empirically measured tree heights for corresponding diameters at the breast height.

Volume structure has pronounced positive asymmetry with asymmetry coefficient 0.397 and platycurtic flatness. The volume of medium tree is $0.527 \text{ m}^3 \cdot \text{tree}^{-1}$, and variability of tree volume structure is 35.8% (Table 5).

Table 5. Numerical indicators of diameter distribution.

n	V_s	S_d	C_v	V_{min}	V_{max}	V_s^2	α_3	α_4
[tree]	$[\text{m}^3 \cdot \text{tree}^{-1}]$	$[\text{m}^3 \cdot \text{tree}^{-1}]$	[%]	$[\text{m}^3 \cdot \text{tree}^{-1}]$	$[\text{m}^3 \cdot \text{tree}^{-1}]$	$[\text{m}^3 \cdot \text{tree}^{-1}]$		
40	0,527	0,189	35,8	0,230	0,945	0,715	0,397	2,364

CONCLUSIONS

The growth elements of foreign tree species *Alnus cordata* (Loisel) Desf., (Italian alder), (*Betulaceae* /Loisel./ Duby) were researched in experimental plot in Erdevik area, locality where this species was first recorded in allochthonous dendroflora of Serbia.

On the basis of the measurement of 40 trees at the end of year 2014, aged 11 years, average tree height was 13.2 m, and dominant tree height 14.6 m, average

diameter at the breast height measured 24.8 cm, and dominant diameter was 32.1 cm, volume of central tree was 0.54 m³, and volume of dominant tree 0.81 m³. Mean age height increment of medium tree was 0.95 m, and by dominant tree it was 1.47 m. Slimness coefficient was 38-74, average value was 54.

According to the growth elements in researched experimental plot, it can be concluded that Italian alder is characterised by fast growth and has potential to be grown in Serbia: as an ornamental species in urban areas and as a fast growing species in forestry plantations.

Acknowledgements: *This paper was realised in the scope of the project „Forest plantations in the function of increasing forest cover of Serbia“ (31041), financed by Ministry for Education and Science of the Republic of Serbia within the programme technological development for the period 2011-2014.*

REFERENCES

- Andrašev S. (2008). Razvojno proizvodne karakteristike selekcionisanih klonova crnih topola (sekcija *Aigerios* DUBY) u gornjem i srednjem Podunavlju. Doktorska disertacija, Šumarski fakultet, Beograd. Pp. 1-427.
- Benson D. R., Vanden Heuvel B. D., Potter D. (2004). Actinorhizal symbioses: diversity and biogeography. In: Gillings M., Holmes A. (eds.): Plant microbiology. Garland Science/BIOS Scientific Publishers, Oxford. Pp. 97–128.
- Bobinac M., Andrašev S., Perović M., Bauer-Živković A., Jorgić Đ. (2015). Italijanska jova (*Alnus cordata* /Loisel./ Desf.) - nova vrsta za alohtonu dendrofloru Srbije. Glasnik Šumarskog fakulteta, 111, Beograd. Pp. 1-10.
- Ducci F, Tani A. (2009). EUFORGEN Technical Guidelines for genetic conservation and use of Italian alder (*Alnus cordata*). Bioversity International, Rome, Italy. Pp. 1-6.
- Krüssmann G. (1984). Manual of cultivated broad-leaved trees and shrubs. Vol. 1. B T Batsford. London.
- Mitchell A. (1979). Die Wald- und Parkbäume Europas. Verlag Paul Parey, Hamburg und Berlin.
- Russel T, Cutler C, Walters M. (2007). Trees of the world. Hermes House, London.
- Shaw K., Wilson B., Roy S. (2014). *Alnus cordata*. The IUCN Red List of Threatened Species. Version 2014.3. (www.iucnredlist.org. visited 30.01.2015).
- Vidaković M. (ed.): (1986). Arboretum Lisičine. ROŠ „Slavonska šuma“ Vinkovci, Zagreb. Pp. 1-87.

ESSENTIAL OIL COMPOSITION OF ONE-YEAR-OLD BOSNIAN PINE NEEDLES

Nikolić Biljana*, Ristić Mihailo, Janačković Pedja, Novaković Jelica, Šarac Zorica, Rajčević Nemanja, Marin D. Petar

*Corresponding author: smikitis@gmail.com

Nikolić B., Ristić M., Janačković P., Novaković J., Šarac Z., Rajčević N., Marin P. (2015). Essential oil composition of one-year-old Bosnian pine needles. In: Ivetić V., Stanković D. (eds.) Proceedings: International conference Reforestation Challenges. 03-06 June 2015, Belgrade, Serbia. *Reforesta*. pp. 282-287.

Abstract: We examined the chemical composition of one-year-old needles from natural populations on Mt. Orjen (Montenegro). The pentane extract is dominated by the following terpenes: germacrene D (25.1%), α -pinene (19.3%), limonene (14.1%), δ^3 -carene (12.1%), β -caryophyllene (7.2%) and β -pinene (7.0%). The terpenic profile is as follows: germacrene D >> α -pinene >> limonene > δ^3 -carene > β -caryophyllene = β -pinene. Among ca. 73 components only β -myrcene (2.2%), α -humulene (1.2%) and α -terpinolene (1.1%) also appear in notable amounts. It is safe to conclude that the one-year-old needles from Mt. Orjen have 10-15% more germacrene D and 10-15% less limonene than other Montenegrin populations, and, except for an abundance of δ^3 -carene, similar content of the other major components. When selecting Bosnian pine individuals for the forestation of high mountain areas, in order to preserve genetic diversity, it is necessary to also take into consideration the variability of terpene composition, since some terpenes have previously been proven to be under genetic control. It is obvious from these results that the age of the needles sampled for terpene analysis must also be taken into consideration.

Keywords: *Pinus heldreichii*, essential oil, limonene, δ^3 -carene, germacrene D, α -pinene.

INTRODUCTION

Pinus heldreichii Christ, relic and subendemic high mountain two-needle pine is naturally distributed on the Balkan Peninsula and southern Italy (Vidaković et al. 1982). According to Fukarek (1951) populations of Bosnian pine originated from Montenegro are regarded as var. *leucodermis*. Differences between this variety and var. *pancici* from Serbia with regard to the essential oil composition have already been proven (by higher contents of germacrene D, α -muurolene and δ -cadinene and by lower contents of α -pinene and camphene (Nikolić et al. 2007).

Recent (unpublished) results which investigate essential oil differences between Serbian population Revuša and Montenegrin populations confirmed this statement, too.

Population studies of terpene composition of two-year old needles of Bosnian pines from Montenegro have been already published and compared with other populations (Nikolić et al. 2007, 2011, 2015). In this article, we present a detailed study of

the essential oil composition of one-year-old needles of *Pinus heldreichii* derived from, up to now, uninvestigated (in regard to essential oil composition) Montenegrin population from Mt. Orjen. Terpene composition of this population was compared with Bosnian pine from Mt. Prenj, Bosnia and Herzegovina and from Mt. Lovćen, Montenegro.

MATERIAL AND METHODS

Twigs with one-year-old needles of *Pinus heldreichii* from the lowest third of tree crown were collected in late summer to early fall from 16 randomly selected trees from Montenegro (Mt. Orjen) and from one tree from Bosnia and Herzegovina (Mt. Prenj). The collected twigs were frozen to -20°C. Voucher specimens were deposited at the Institute of Forestry, Belgrade, Serbia.

Methods of isolation of essential oils, compound identification, GC/FID analysis and GC/MS analysis have been already described (Nikolić et al. 2007).

The calculation of arithmetic means and standard deviations were carried out with the software *Statgraphics Plus* (version 5.0; Statistical Graphics Corporation, USA).

RESULTS AND DISCUSSION

In the *n*-pentane extract of one-year-old Bosnian pine needles from Mt. Orjen four compounds dominate: germacrene D (25.1%), α -pinene (19.3%), limonene (14.1%) and δ^3 -carene (12.1%) (Table 1). β -caryophyllene and β -pinene have medium to high abundance (7.2% and 7.0%, respectively). Among ca. 73 components only β -myrcene (2.2%), α -humulene (1.2%) and α -terpinolene (1.1%) also have notable amounts. α -Terpineol, trans- β -farnesene and abienol appear in traces (not presented).

These results were compared with terpene profile of one-year-old needles from one *Pinus heldreichii* tree from Mt. Prenj. Among ca. 54 compounds, limonene (32.6%), germacrene D (19.3%) and α -pinene (16.6%) dominate (Table 1). Medium to high abundance have β -caryophyllene (9.4%) and β -pinene (5.6%). Isopimarol (2.5%), β -myrcene (2.1%), α -humulene (1.5%) and kauran-18-oic acid (1.2%) are less abundant.

Terpenic profiles of one-year-old needles of Bosnian pines from mountains Orjen and Prenj differ in abundance and range of the most abundant (germacrene D and limonene, respectively) and other main compounds. Population Orjen has more germacrene D, α -pinene and δ^3 -carene but less limonene, β -caryophyllene and β -pinene (Table 1, Fig. 1). Consequently, terpenic profile of Bosnian pines from Mt. Orjen, Montenegro (*germacrene D* >> *α -pinene* >> *limonene* > *δ^3 -carene* > *β -caryophyllene* = *β -pinene*, where: =, > and >> represent relative differences of 0.1-1%, 1.1-5.0% and 5.0-15.0%, respectively, after Petrakis et al. 2001) significantly differ from terpenic profile of Bosnian pine from Mt. Prenj, Bosnia and Herzegovina (*limonene* >> *germacrene D* > *α -pinene* >> *β -caryophyllene* > *β -pinene*). Regarding all trees together (ca. 17 trees) we can conclude that one-year-old needles have average terpenic profile as following: *germacrene D* >> *α -pinene* > *limonene* > *δ^3 -carene* > *β -caryophyllene* = *β -pinene* (Table 1).

PROCEEDINGS
 International Conference **REFORESTATION CHALLENGES**
 03-06 June 2015, Belgrade, Serbia

Table 1. Arithmetic means of chemical compounds of the one-year-old needle essential oils of *Pinus heldreichii* populations. Standard deviations are given in parenthesis.

Entry	Compound ^{a)}	Content (%)		Average Content (%)
		Mt. Orjen	Mt. Prenj	
1	(E)-Hex-2-enal	0.18 (0.14)	0.10 (0.00)	0.18 (0.14)
2	(Z)-Hex-3-en-1-ol	0.65 (0.35)	-	0.61 (0.35)
3	n-Hexan-1-ol	0.17 (0.10)	0.02 (0.00)	0.16 (0.10)
4	Tricyclene	0.17 (0.05)	0.20 (0.00)	0.17 (0.05)
5	α -Thujene	0.04 (0.02)	-	0.04 (0.02)
6	α-Pinene	19.28 (4.90)	16.61 (0.00)	19.12 (4.79)
7	Camphene	0.66 (0.14)	0.77 (0.00)	0.67 (0.14)
8	Sabinene	0.43 (0.21)	0.09 (0.00)	0.41 (0.22)
9	β-Pinene	7.00 (2.07)	5.56 (0.00)	6.92 (2.03)
10	β -Myrcene	2.17 (0.61)	2.09 (0.00)	2.16 (0.59)
11	α -Phellandrene	0.03 (0.01)	-	0.03 (0.01)
12	δ^3-Carene	12.06 (8.05)	-	11.35 (8.05)
13	α -Terpinene	0.04 (0.02)	-	0.04 (0.02)
14	p-Cymene	0.01 (0.01)	-	0.00 (0.01)
15	Limonene	14.06 (9.11)	32.62 (0.00)	15.15 (9.90)
16	cis- β -Ocimene	0.01 (0.01)	-	0.01 (0.01)
17	trans- β -Ocimene	0.50 (0.64)	0.10 (0.00)	0.48 (0.63)
18	γ -Terpinene	0.13 (0.07)	-	0.12 (0.07)
19	α -Terpinolene	1.06 (0.65)	0.19 (0.00)	1.01 (0.67)
20	Linalool	-	0.13 (0.00)	0.01 (0.00)
21	Unknown 1	-	0.02 (0.00)	0.00 (0.00)
22	Terpinene-4-ol	0.01 (0.01)	-	0.01 (0.01)
23	Bornyl acetate	0.18 (0.36)	-	0.17 (0.36)
24	trans-Verbenyl acetate	0.07 (0.07)	-	0.06 (0.07)
25	cis-Pinocarvyl acetate	0.03 (0.03)	-	0.02 (0.03)
26	δ -Elemene	0.02 (0.03)	-	0.02 (0.03)
27	α -Terpinyl acetate	0.59 (0.37)	0.65 (0.00)	0.60 (0.36)
28	α -Copaene	0.07 (0.02)	0.08 (0.00)	0.07 (0.02)
29	β -Bourbonene	-	0.06 (0.00)	0.00 (0.00)
30	β -Cubebene	0.08 (0.03)	0.08 (0.00)	0.08 (0.03)
31	β -Elemene	0.08 (0.03)	0.08 (0.00)	0.08 (0.03)
32	Longifolene	0.51 (0.70)	-	0.48 (0.70)
33	β-Caryophyllene	7.19 (2.05)	9.41 (0.00)	7.32 (2.06)
34	Calarene	0.33 (0.13)	-	0.31 (0.13)
35	β -Copaene	-	0.27 (0.00)	0.02 (0.00)
36	6,9-Guaiadiene	0.12 (0.05)	0.11 (0.00)	0.12 (0.05)
37	α -Humulene	1.16 (0.31)	1.53 (0.00)	1.18 (0.31)
38	trans-Muurola-3,5-diene	0.05 (0.03)	0.03 (0.00)	0.05 (0.03)
39	γ -Muurolene	0.14 (0.07)	-	0.13 (0.07)
40	Germacrene D	25.09 (9.83)	19.32 (0.00)	24.75 (9.62)
41	γ -Amorphene	0.06 (0.02)	0.05 (0.00)	0.06 (0.02)
42	α -Muurolene	0.21 (0.08)	0.39 (0.00)	0.22 (0.09)
43	γ -Cadinene	0.16 (0.06)	0.16 (0.00)	0.16 (0.06)
44	δ -Cadinene	0.38 (0.13)	0.33 (0.00)	0.38 (0.13)
45	α -Cadinene	-	0.05 (0.00)	0.00 (0.00)
46	trans-Longipinocarveol	0.04 (0.07)	-	0.04 (0.07)
47	Germacrene D-4-ol	0.50 (0.12)	0.17 (0.00)	0.48 (0.23)
48	Caryophyllene oxide	0.07 (0.04)	0.24 (0.00)	0.08 (0.06)
49	τ -Cadinol	0.08 (0.03)	-	0.08 (0.03)
50	α -Cadinol	0.06 (0.02)	0.10 (0.00)	0.07 (0.02)

PROCEEDINGS
International Conference **REFORESTATION CHALLENGES**
03-06 June 2015, Belgrade, Serbia

Entry	Compound ^{a)}	Content (%)		Average
		Mt. Orjen	Mt. Prenj	Content (%)
51	Khusinol	0.09 (0.04)	0.14 (0.00)	0.10 (0.04)
52	<i>trans, trans</i> -Farnesol	0.09 (0.21)	0.17 (0.00)	0.10 (0.20)
53	14-hydroxy- α -Muurolene	0.04 (0.07)	0.07 (0.00)	0.04 (0.06)
54	Neophytadiene, Isomer I	-	0.08 (0.00)	0.00 (0.00)
55	Farnesyl acetate	0.06 (0.06)	0.08 (0.00)	0.06 (0.05)
56	Benzyl salicylate	0.01 (0.02)	0.19 (0.00)	0.02 (0.08)
57	(5E,9E)-Farnesyl acetone	0.15 (0.06)	0.22 (0.00)	0.16 (0.06)
58	Cembrene	-	0.05 (0.00)	0.00 (0.00)
59	Sandaracopimara-8(14),15-diene	0.02 (0.01)	0.27 (0.00)	0.04 (0.08)
60	Kaur-15-ene	0.28 (0.08)	0.51 (0.00)	0.29 (0.10)
61	E,E-Geranyl linalool	0.07 (0.02)	-	0.07 (0.02)
62	Thunbergol	0.75 (0.65)	0.86 (0.00)	0.76 (0.63)
63	Abietadiene	0.07 (0.03)	0.05 (0.00)	0.07 (0.03)
64	Abieta-8(14),13(15)-diene	0.04 (0.01)	-	0.04 (0.01)
65	Sandaracopimarinal	0.11 (0.08)	0.16 (0.00)	0.11 (0.08)
66	Unknown 2	0.08 (0.03)	0.14 (0.00)	0.08 (0.03)
67	Docosane	-	0.14 (0.00)	0.01 (0.00)
68	Sclareol	0.65 (0.20)	0.96 (0.00)	0.67 (0.21)
69	7- α -hydroxy-Manool	0.01 (0.04)	-	0.01 (0.04)
70	Sandaracopimarinal	0.16 (0.10)	0.24 (0.00)	0.17 (0.09)
71	Dexydroabietal	0.02 (0.01)	0.12 (0.00)	0.03 (0.02)
72	Isopimarol	0.84 (0.31)	2.50 (0.00)	0.94 (0.50)
73	Torulolol	0.13 (0.14)	0.19 (0.00)	0.14 (0.14)
74	Pimaric acid	0.06 (0.08)	-	0.06 (0.08)
75	Kauran-18-oic acid	0.17 (0.07)	1.21 (0.00)	0.23 (0.29)
76	Triacotane	0.09 (0.05)	-	0.09 (0.05)
77	Octacosanol	0.02 (0.00)	-	0.02 (0.00)
Total [%]		100.00	100.00	100.00
Monoterpene hydrocarbons		57.66	58.24	57.69
O-Containing monoterpenes		0.88	0.79	0.87
Total Monoterpenes		58.53	59.02	58.56
Sesquiterpene hydrocarbons		35.65	31.97	35.43
O-Containing sesquiterpenes		1.20	1.20	1.20
Total Sesquiterpenes		36.85	33.16	36.63
Diterpene hydrocarbons		0.34	0.91	0.38
O-Containing diterpenes		3.06	6.29	3.31
Total Diterpenes		3.40	7.19	3.68
Others^{b)}		1.13	0.46	1.09
Unknown		0.08	0.16	0.09
Total [%]		100.00	100.00	100.00

^{a)} Literature names rather than fully systematic names are given.

^{b)} Aliphatic aldehydes and alcohols, aromatic acid esters, *n*-alkanes.

Terpenic profiles of one-year-old needles of Bosnian pines significantly differ from this of two-year-old needles of Mt. Lovćen, Montenegrin population which is geographically close to Mt. Orjen (about 25 km in air distance), as following: *limonene* > α -*pinene* > *germacrene D* >> β -*caryophyllene* > β -*pinene* (Fig. 1; also see Table 3 from Nikolić et al. 2007). We can conclude that Bosnian pines from west Montenegro (Mt. Orjen and Mt. Lovćen) have *germacrene D* and *limonene* as the most abundant terpenes in one- and two-year-old needles, respectively, and very abundant α -*pinene* in both cases.

We can also accent the abundant δ^3 -carene in one-year-old needles. But, Bosnian pine from Mt. Prenj (Bosnia and Herzegovina) is unique owing to very abundant limonene in one-year-old needles. It also has significantly less germacrene D in one- (19.3%) than in two-year-old needles (Chalchat et al. 1994).

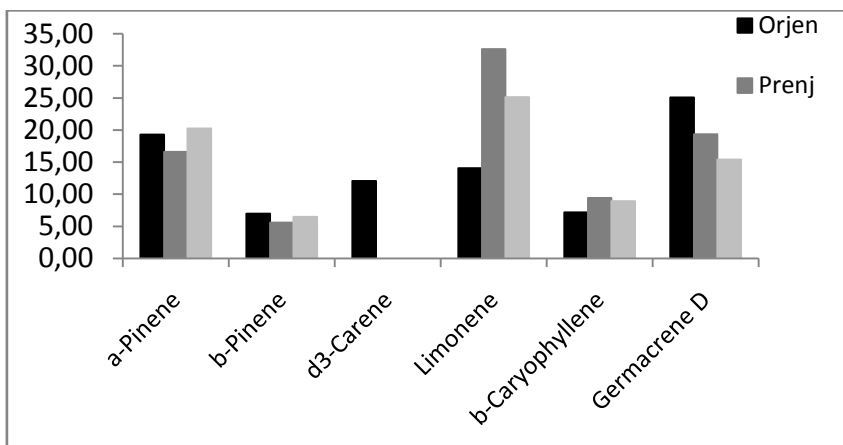

Figure 1. Abundance of Main Terpenes of Bosnian Pine Needles: One-year-old (mountains Orjen and Prenj); Two-year-old (Mt. Lovćen).

Different abundance of main and other terpene compounds affected different representation of main terpene classes. One-year-old needles in average have more monoterpenes (58.6%) and less sesquiterpenes (36.9%) than two-year-old needles (57.0% and 38.4%, respectively, Figure 2), but not significantly. But, abundance of total diterpenes is higher in one-year (3.7% in average) than in two-year-old needles (1.5%), especially in profile of *P. heldreichii* from Mt. Prenj (7.2%).

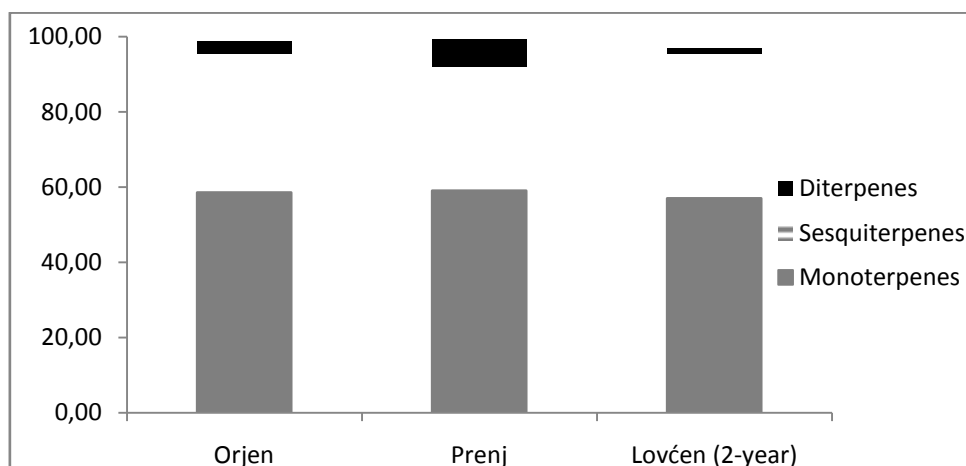

Figure 2. Main Terpene Classes of *Pinus heldreichii* Needles: One-year-old (mountains Orjen and Prenj); two-year-old (Mt. Lovćen).

CONCLUSIONS

It is safe to conclude that one-year-old needles from Mt. Orjen have 10-15% more germacrene D and 10-15% less limonene than geographically close Mt. Lovćen and other Montenegrin populations and, except for an abundance of δ^3 -carene, similar content of the other major components. Differences could be the consequence of different needle age (essential oils of Lovćen, Zeletin and Bjelasica originated from two-year-old needles). Obtained results of Bosnian pine from Mt. Prenj, which have significantly less germacrene D in one- than in two-year-old needles, approved this assumption.

When selecting Bosnian pine individuals for the forestation of high mountain areas, in order to preserve genetic diversity, it is necessary to also take into consideration preservation of terpene composition variability, since some terpenes in other conifers had been proven to be under genetic control (Sampedro et al. 2010 and references cited therein).

Acknowledgement: This work is part of a Research project 173029 supported by the *Ministry of Education, Science, and Technological Development of the Republic of Serbia*.

REFERENCES

- Chalchat J., Garry R. Ph., Gorunović M. S. (1994). Contribution a l etude chimiotaxonomique des pins endemiques des Balkans: Variation de la composition chimique de l huile essentielle de *Pinus heldreichii* Christ., Pinaceae differentes selon le site, la partie et l'age des specimens etudies. *Pharmazie* 49: 852 – 854.
- Fukarek P. (1951). Novi varietet munike sa područja Srbije i Sandžaka (Crna Gora) (*Pinus heldreichii* Chr. var *Pančići* n.var.). *Godišnjak Biološkog Instituta IV/1* (Sarajevo): 41 – 50.
- Nikolić B., Ristić M., Bojović S., Marin P.D. (2007). Variability of the needle essential oils of *Pinus heldreichii* from different populations in Montenegro and Serbia. *Chemistry & Biodiversity* 4: 905-916.
- Nikolić B., Ristić M., Tešević V., Marin P.D., Bojović S. (2011). Terpene chemodiversity of relict conifers *Picea omorika*, *Pinus heldreichii*, and *Pinus peuce*, endemic to Balkan. *Chemistry & Biodiversity* 8: 2247-2260.
- Nikolić B., Ristić M., Bojović S., Krivošej Z., Matevski V., Marin P.D. (2015). Population variability of essential oils of *Pinus heldreichii* from the Scardo-Pindic Mountains Ošljak and Galičica. *Chemistry & Biodiversity* 12: 295-308.
- Petrakis P. V., Tsitsimpikou C., Tzakou O., Couladis M., Vagias C., Roussis V. (2001). Needle volatiles from five *Pinus* species growing in Greece. *Flavour and Fragrance Journal* 16: 249 - 252.
- Sampedro L., Moreira X., Lusía J., Peñuelas J., Zas R. (2010). Genetics, phosphorus availability, and herbivore-derived induction as sources of phenotypic variation of leaf volatile terpenes in a pine species. *Journal of Experimental Botany* 61: 4437 - 4447.
- Vidaković M. (1982). Četinjače. Morfologija i varijabilnost. JAZU i Sveučilišna naklada Liber, Zagreb, 710 p.

VARIABILITY OF MORPHOMETRIC CHARACTERISTICS OF SEED AND HEIGHT OF ONE-YEAR-OLD SEEDLINGS OF DIFFERENT POPULATIONS OF BEECH (*Fagus moesiaca*/Domin, Maly/Czeczott) IN SERBIA

Popović Vladan^{*}, Šijačić-Nikolić Mirjana, Ristić Danijela

^{*}Corresponding author: vladanpop79@gmail.com

Popović V., Šijačić-Nikolić M., Ristić D. (2015). Variability of morphometric characteristics of seed and height of one-year-old seedlings of different populations of beech (*Fagus moesiaca*/Domin, Maly/Czeczott) in Serbia. In: Ivetić V., Stanković D. (eds.) Proceedings: International conference Reforestation Challenges. 03-06 June 2015, Belgrade, Serbia. Reforesta. pp. 288-295.

Abstract: The aim of the research in this paper is to assess the genetic variability of beech in the area of its natural range in Serbia. In the autumn 2013 the seed was collected from eight populations of beech which represent the entire range of this species in Serbia. This paper presents the analysis of the morphometric characteristics of seed and the analysis of the height of one-year-old seedlings of eight Beech populations (*Fagus moesiaca*/Domin, Maly/Czeczott) in Serbia. From each population was taken a sample of 100 pieces of beechnut and on them were measured length, width and mass. In the spring 2014 in the seedling nursery of Institute of Forestry in Belgrade was established a nursery test and during the autumn of the same year was measured the height of seedlings that were 1+0 year old. Based on the obtained results the statistically significant differences were noticed in the values of the observed characteristics. The sampled populations were mutually statistically very different in all observed characteristics of seed. The highest mean values of characteristics has the seed of population I (FMU "Zlatskesume" FE "Timockesume" Boljevac) and the lowest mean values have the seed of populations II (FMU "Mali Jastrebac" FE "Nis", Nis), VI (FMU "Goc-Gvozdac", Faculty of forestry Belgrade) and VIII (FMU "Jasenovo-Bozetic" FE "Prijeplje", Prijeplje). For the height of one-year-old seedlings was also noticed the statistically significant difference among populations. The mean values of height of one-year-old seedlings were the lowest in population VIII (FMU "Jasenovo-Bozetic" FE "Prijeplje" from Prijeplje) and the highest in population I (FMU "Zlatskesume" FE "Timockesume" Boljevac). The obtained results indicate a significant genetic inter- and intra-variability of observed characteristics of populations and represent the starting point for further researches.

Key words: beech, populations, seed, seedlings, variability.

INTRODUCTION

The quality and quantity of forest trees yield are for a long time the research subject of forest science and profession. There are many researches in the

country and abroad that deal with this, for forestry, very important scientific field. But, the exploration level of genetic variability of different forest tree species seed yield quality and quantity and the possibility of their use in our conditions are still below the actual need and they are not in line with the economic importance which this field can provide. Thanks to research results of the researchers Tucovic 1975, Mrva 1976, 1984, Popnikola 1978, Tucovic, Stilinovic 1982, Tucovic, Isajev 1985, Isajev, 1987, Tosic 1991, Mataruga 2003, Lucic 2012, Sijacic-Nikolic et al. 2007, 2008, 2009, 2010, Popovic et al. 2012, Nonic et al. 2012 etc., the knowledge related to inter- and intra-population variability of different species at the seed level and in the juvenile development phase has been gradually completed. Most researches on beech in Serbia have been performed in the later stages of the development of an individual and the specificities and variability have been registered at the different sites (Jovonovic 1950, Misic 1955, 1956, Tucovic, Jovanovic 1965, Jovanovic 1971, Glisic 1973). A small number of scientific papers have recently researched the seed, seedlings and plants in juvenile development phase (Bobinac 1999, 2002, Bobinac, Vilotic 1995, 1996, Ocokoljic, Anastasijevic 2004, Sijacic-Nikolic et al. 2006, 2007, 2012).

The results obtained in the study of variability of morphometric characteristics of seed and the height of one-year-old seedlings have been used to preliminarily get acquainted with the genetic variability of the studied populations and to improve the production of quality seed and planting material of beech in Serbia.

MATERIAL AND METHOD

The research subject consists of eight populations that represent the range of beech in Serbia, whose general characteristics are shown in Table 1 and the geographical position in Figure 1. The seed collection was carried out in autumn 2013. After collection the seed was dried at 15% humidity and stored in a refrigerator at 3-5° C.

Table 1: General characteristics of analyzed beech populations

Population, FMU, FE	Provenance	Altitude	Aspect	Ecological affiliation
I FMU "Zlotskesume" FE "Timockesume" Boljevac	Northeastern Serbia	895-940	Northwest	<i>Fagenion moesiaceae montanum</i>
II FMU "Mali Jastrebac" FE "Nis" Nis	Southern Serbia	790-850	Northeast	<i>Fagenion moesiaceae montanum</i>
III FMU "Istocna Boranja" FE „Boranja" Loznica	Western Serbia	670-820	Southeast	<i>Fagenion moesiaceae submontanum</i>
IV FMU "Ravne-548" PE "NP Fruska Gora"	Fruska Gora	360-380	North, Northeast	<i>Qerceto-fagetyum typicum</i>
V FMU "Crnareka" Faculty of forestry Belgrade	Northeastern Serbia	550-700	Northeast	<i>Fagenion moesiaceae submontanum</i>
VI FMU "Goc-gvozdac" Faculty of forestry Belgrade	Southern Serbia	900-940	North, Northeast	<i>Abieti-Fagetum serpentanicum</i>
VII FMU "Vitanovaca- Vratacelje"	Northeastern Serbia	900-950	North, Northeast	<i>Fagenion moesiaceae montanum</i>
FE "JužniKučaj" Despotov				
VIII FMU "Jasenovo-Bozetic" FE "Prijepolje" Prijepolje	Western Serbia	1000-1040	Northwest	<i>Fagenion moesiaceae montanum</i>

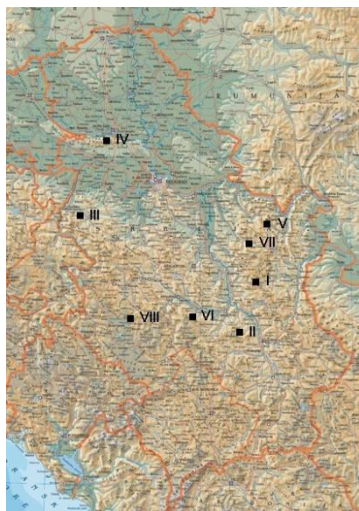

Figure 1: Geographical position of analyzed beech populations

Measurements of morphometric characteristics were performed on a random sample that comprised 100 pieces of beechnuts. The length, width and mass of beechnuts were measured. The length and the width of beechnuts were measured with a verniercaliper with an accuracy of 0.01 mm and the mass of beechnuts was measured with an electronic scale with an accuracy of 0.01 g. In April 2014 the seedsowing was performed in containers type Bosnaplast 18. The containers were filled with a substrate that is used in a regular nursery production. During the growing season the watering and protection of insolation were carried out regularly. In October 2014 was performed the measurement of the height of one-year-old seedlings. The measurement was performed with a ruler with an accuracy of 0.1 cm.

For studied morphometric characteristics were calculated mean value, standard deviation, minimum and maximum values. The significance of differences between mean values of the analyzed characteristics was tested by the analysis of variance for a single factor (One-Way ANOVA). The testing of the significance of difference between the studied populations was performed by post hoc test of the least significant difference (Tukey HSD test) for $p < 0.05$. The ratio of morphometric characteristics of seed and the height of one-year-old seedlings was examined by the correlation analysis. The measured data were statistically analyzed in a statistical software package Statistica 7 (StatSoft, Inc. 2004).

RESULTS AND DISCUSSION

On the Figure 2 are presented the results of mean values of all eight observed populations' beechnut length. Population I (FMU "Zlotskesume" FE "Timockesume" Boljevac) has the highest value of beechnut length while the lowest value of the same characteristic has the population VIII (FMU "Jasenovo-Bozetici" FE "Prijepolje" Prijepolje). According to obtained results the mean value of beechnut length ranges from 15.7 mm to

18.6 mm with minimum of 13.4 mm and maximum of 20.7 mm and the standard deviation ranges from 0.65 mm to 1.56 mm. In comparison with the literature data that indicate that the average beechnut length is about 16 mm (Stilinović 1985) or in the range from 15 mm to 17 mm (Šijačić-Nikolić et al. 2007) it can be concluded that the seed of the studied populations according to its length values is closer to the upper values of the literature data and it even exceeds them.

The highest mean value of beechnut width (Figure 3) has the population I (FMU “Zlatskesume” FE “Timockesume” Boljevac) and the lowest value has the population II (FMU “Mali Jastrebac” FE “Nis” Nis). The measurement results have shown that the mean value of beechnut width ranges from 8.2 mm to 11.2 mm with minimum of 6.8 mm and maximum of 16.5 mm and the standard deviation ranges from 0.60 mm to 1.65 mm. According to the available literature data the beechnut width ranges from 9 to 10 mm (Šijačić-Nikolić et al. 2007).

Population I (FMU “Zlatskesume” FE “Timockesume” Boljevac) also has the greatest mean value of beechnut mass, while the lowest mean value has the population V (FMU “Crnareka” Faculty of forestry Belgrade) (Figure 4). The mean value of beechnut mass ranges from 0.18 g to 0.29 g with the minimum of 0.06 g, the maximum of 0.44 g and the standard deviation ranges from 0.03 g to 0.09 g.

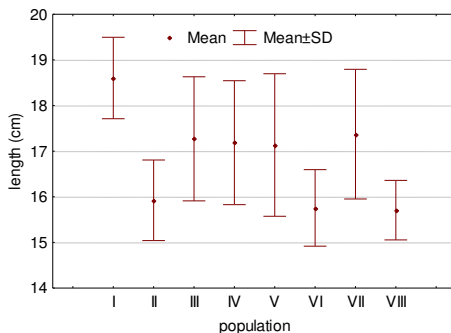

Figure 2. Mean values of studied populations' beechnut length

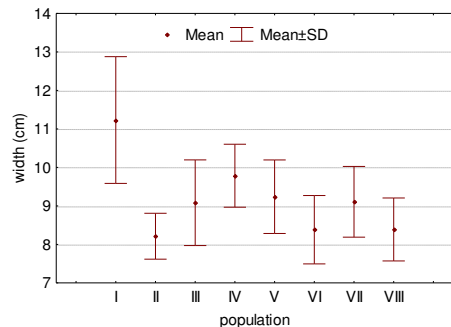

Figure 3. Mean values of studied populations' beechnut width

The greatest mean value of height of one-year-old seedlings was measured in population I (FMU “Zlatskesume” FE “Timockesume” Boljevac) and the lowest in the population VIII (FMU “Jasenovo-Bozetic” FE “Prijepolje” Prijepolje) (Figure 4). The measurement results show that the mean value of seedlings' height ranges from 10.8 to 14.6, the minimum value is 5.4 cm, the maximum value is 22.4 cm and the standard deviation ranges from 1.2 cm to 3.4 cm. According to standard which is currently in use (SRPS D.Z2.112.1967) the beech seedlings at (1+0) age and the height above 15 cm belong to the quality class I and seedlings with the height below 15 cm belong to quality class II. Based on measurement results obtained in this research it can be concluded that the most seedlings belong to the quality class II. The reason is that for the nursery production the seed and the seedlings have been selected by size and for the need of this research it was

used the representative sample of offspring from different populations regardless of the size of seeds and seedlings.

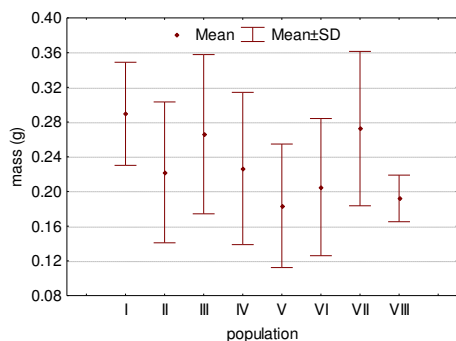

Figure 4. Mean values of studied populations' beechnut mass

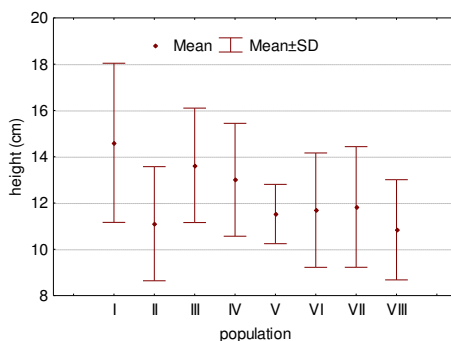

Figure 5. Mean values of height of one-year-old beech seedlings in studied populations

Table 2. The variance analysis for the observed characteristics of seed and one-year-old seedlings

Characteristic	SS	MS	F	p
Length of beechnut	141.50	20.21	14.90	0.0000
Width of beechnut	135.80	19.40	18.96	0.0000
Mass of beechnut	0.22	0.031	5.40	0.0000
Height of one-year-old seedlings	378.07	54.01	8.81	0.0000

The results of the variance analysis (Table 2) in which the source of variability is the population show the existence of statistically significant differences at the level $p < 0.05$ for all observed morphometric characteristics of seed as well as for the observed height of one-year-old seedlings. The determined statistically significant differences among populations require their analysis with the aim of determination of the existence of geographic pattern. This analysis was performed using post-hoc test (Tukey HSD test) for all observed characteristics. The populations among which there were no the statistically significant differences are connected with the same letter (Table 3).

Table 3. The groups of populations obtained by Tukey HSD test for the observed characteristics of seed and one-year-old seedlings

Length of beechnut		Width of beechnut		Mass of beechnut		Height of one-year-old seedlings	
Population	Mean	Population	Mean	Population	Mean	Population	Mean
VIII	15.71 ^a	II	8.21 ^a	V	0.18 ^a	VIII	10.8 ^a
VI	15.76 ^a	VI	8.38 ^{ab}	VIII	0.19 ^a	II	11.1 ^{ab}
II	15.92 ^a	VIII	8.39 ^{ab}	VI	0.21 ^{ab}	V	11.5 ^{ab}
V	17.14 ^b	III	9.08 ^{abc}	II	0.22 ^{abc}	VI	11.7 ^{ab}
IV	17.19 ^b	VII	9.11 ^{abc}	IV	0.23 ^{abc}	VII	11.8 ^{abc}
III	17.27 ^b	V	9.24 ^{bc}	III	0.27 ^{bc}	IV	13.0 ^{bcd}
VII	17.37 ^b	IV	9.78 ^c	VII	0.27 ^{bc}	III	13.6 ^{cd}
I	18.60 ^c	I	11.23 ^d	I	0.29 ^c	I	14.6 ^d

For the beechnut length the Tukey HSD test forms 3 groups, for the beechnut width 4 groups, for the beechnut mass 3 groups and for the height of one-year-old seedlings the Tukey HSD test forms 4 groups (Table 3). For all observed characteristics the population I (FMU "Zlatskesume" FE "Timockesume" Boljevac) is in the group with the greatest mean values while the populations II FMU "Mali Jastrebac" FE "Nis" Nis, VI FMU "Goc-gvozdac" Faculty of forestry Belgrade and VIII FMU "Jasenovo-Bozetic" FE "Prijeplje" Prijeplje are in the group with the lowest mean values of all observed characteristics. The results of this test show some geographical regularity in grouping of the populations. The populations II, VI and VIII are located in the southernmost part of the studied area at about the same latitude, in the zone of more than 800 m above sea level.

Table 4. The correlation coefficients (R) between morphometric characteristics of seed and the height of one-year-old seedlings.

	Height of one-year-old seedlings
Length of beechnut	0.24**
Width of beechnut	0.22**
Mass of beechnut	0.17*

Marked correlations are significant at $p < 0.05$ (*) and $p < 0.01$ (**).

The calculated correlation coefficients between morphometric characteristics of seed and the height of one-year-old seedlings are statistically significant. The weakest correlation is between the beechnut mass and the height of the seedlings while the correlation between the beechnut length and the height of the seedlings as well as the correlation between the beechnut width and the height of the seedlings are approximately the same.

CONCLUSIONS

The obtained results of the variability analysis of morphometric characteristics of seed and the height of one-year-old seedlings of eight beech populations contribute to better understanding of analyzed characteristics and their effect on differentiation of populations.

In all analyzed characteristics the population I FMU "Zlatskesume" FE "Timockesume" Boljevac stands out with the greatest values while the populations II FMU "Mali Jastrebac" FE "Nis" Nis, VI FMU "Goc-gvozdac" Faculty of forestry Belgrade and VIII FMU "Jasenovo-Bozetic" FE "Prijeplje" Prijeplje have the lowest values of the all analyzed characteristics.

The presented results of morphometric characteristics of seed and the height of one-year-old seedlings indicate the inter-population variability of observed characteristics and they can be used for preliminary assessment of genetic variability of studied beech populations in Serbia.

Acknowledgements: *The research is financed by the Ministry of Science and Technological Development of the Republic of Serbia, Project TR 31070 "The development of technological procedures in forestry with a view to an optimum forest cover realization" (2011-2014).*

REFERENCES

- Bobinac M. (1999). Contribution to the knowledge of ecology and development of seedlings and offspring of beech [*Fagus moesiaca* /Domin, Maly/ Czczott]. Acta biologica iugoslavica - seria D: Ecology, 33 (Supplementum), pp. 109-116.
- Bobinac M. (2002). Ontogeny of beech seedlings in the first vegetation period in stand conditions. Bulletin of Faculty of Forestry, No. 86, pp. 81-91 (in Serbian).
- Bobinac M., Vilotić D. (1995). Contribution to the study of beech (*Fagus moesiaca*/Domin, Maly/Czczott) seedlings in multiphase growing from the aspect of morfological-anatomical analysis.in: Jubilee international conference 70 years of Forestry Education in Bulgaria, Jubilee Scientific Session 7-9. 06., Sofia, Vol. I, pp. 492-499.
- Bobinac M., Vilotić D. (1996). Contribution to the study of morphological-anatomical characteristics of beech (*Fagus moesiaca* /Domin, Maly/Czczott) seedlings. Soil and plant, vol. 45, No. 1, pp. 57-65.
- Glišić M. (1973). A contribution to the knowledge of variability in Balkan beech *Fagus moesiaca* (Domin, Maly) Czczott. - variety with sharp toothed margin of leaves. Proceedings of the Institute of forestry and wood industry No. 12, pp. 5-25 (in Serbian).
- Isajev V. (1987). Serbian spruce (*Picea omorika* Panč./Purk.) breeding on genetic-selection basis] – PhD thesis – Belgrade (in Serbian).
- Isajev V., Mančić A. (2001). Seed production, Faculty of forestry Banja Luka (in Serbian).
- Jovanović B. (1950). On some morphological and biological characteristics of our beech. Proceedings of the Institute of Ecology and Biogeography of SANU, vol. 1, p. 67-73 (in Serbian).
- Jovanović M. (1971). Breeding of beech (*Fagus moesiaca* (Domin, Maly) Czczott) in Serbia, PhD Thesis Faculty of forestry Belgrade (in Serbian).
- Lučić A. (2012). Establishment of Scots pine (*Pinus sylvestris* L.) forests in Serbia based on ecological-genetic bases. PhD thesis, Belgrade (in Serbian).
- Mataruga M. (2003). Genetic-selection bases of enhancing the seedling production of different provenances of Austrian pine (*Pinus nigra* Arnold). PhD thesis. Faculty of Forestry, Belgrade (in Serbian).
- Mišić V. (1955). Ancestral manifestation on leaves of the Balkan beech (*Fagus moesiaca* Czczott) in Yugoslavia Archives of Biological Sciences, 1-2, (115-120) (in Serbian).
- Mišić V. (1956). Individual polymorphism of Balkan beech leaves of the same tree. Proceedings of the Institute of Ecology and Biogeography of SANU, No.6, pp. 1-25 (in Serbian).
- Mrva F. (1976). Quantitative characteristics of flowering and cone yield in a clonal seed orchard of European larch. Presentation in the section for genetics and tree breeding.
- Mrva F. (1984). Seed orchards of conifers in Croatia. Forestry review 1-2 and 3-4; p:65-77. Skopje.
- Nonić M., Popović V., Kerkez I., Šijačić-Nikolić M. (2013). Variability of morphometric characteristics of seed of different sweet cherry (*Prunus avium* L.) test trees from the territory of Belgrade, Forestry, no. 1-2, Belgrade: 113-123 (in Serbian).
- Ocokoljić M., Anastasijević N. (2004). Variability of half-sib progeny properties as the base of Moesian beech (*Fagus moesiaca* (Maly) Czczott) breeding, Bulletin of the Faculty of Forestry, Belgrade, No. 90, 129-140 (in Serbian).
- Popnikola N. (1978). Production of quality seeds in an experimental orchard of Scots pine (*Pinus sylvestris* L.) in Kruševo. Annual bulletin of the Faculty of Forestry, No. 28. pp: 113-122. Skopje.
- Popović V., Šijačić-Nikolić M., Rakonjac Lj., Jakanović D. (2012). Variability in cone morphometric characters among test trees of bald cypress (*Taxodium distichum* L. Rich.) in seed stand near BačkaPalanka. Sustainable Forestry, collection 65-66, p.: 15-27.

- Tošić M. (1991). Genetic variability of Scots pine (*Pinus sylvestris* L.) in Western Serbia as a basis for establishing criteria for the new selections. PhD thesis. Faculty of Forestry, Belgrade (in Serbian).
- Tucović A. (1975). Practicum in genetics with plant breeding. Publishing company 'Građevinska knjiga'. Belgrade, pp: 1-233 (in Serbian).
- Tucović A., Isajev V. (1985). Spontaneous and induced variability of spruce seedlings from the seed object "Bela Zemlja" in region Titovo Užice. Bulletin of Faculty of Forestry. Belgrade, No. 64; pp: 47-65 (in Serbian).
- Tucović A., Jovanović M. (1965). Contribution to the study of variability of beech in Serbia. Proceedings of the Institute of forestry and wood industry, Book V, p.115-122 (in Serbian).
- Tucović A., Stilinović S. (1982). Status and Problems in the production of genetic quality seed in the Socialist Republic of Serbia from seed orchards Bulletin of the Faculty of Forestry, Belgrade, No. 58; pp: 3-21 (in Serbian).
- Stilinović S. (1985): Seed production of forest and ornamental trees and shrubs. Belgrade, Faculty of forestry (in Serbian).
- SRPS D.ZZ.112, 1968. Forest seedlings – Broadleaved species (in Serbian).
- StatSoft Inc., 2004. STATISTICA, version 7.
- Šijačić-Nikolić M., Ivetić V., Knežević R., Milovanović J. (2007). Analysis of the characteristics of seeds and seedlings of different provenances of beech. Acta biologica iugoslavica - serial G: Acta herbologica; 16(1):15-27.
- Šijačić-Nikolić M., Vilotić D., Radošević G. (2006). Effect of controlled decomposing fertilizers on morpho-anatomical characteristics one-year-old beech seedlings. Forestry, no 1-2,149-156 (in Serbian).
- Šijačić-Nikolić M., Milovanović J., Knežević R. (2006). Determination of phenotypic stability of perennial seedlings of different provenances of beech. Bulletin Faculty of Forestry, University of Banja Luka, no. 6, 61-71 (in Serbian).
- Šijačić-Nikolić M., Milovanović J., Nonić M., Knežević R., Babić.V. (2012). Ecotypical characterization of the genetic variability of beech provenances from Eastern Europe based on morphometric characteristics of leaves. Bulletin of Faculty of Forestry, Belgrade no. 106, 197-214 (in Serbian).
- Šijačić-Nikolić M., Vilotić D., Knežević R., Milovanović J. (2009). Fruit, seed and seedling variability of Paulownia elongata S.Y. Hu test tree in Belgrade. Acta herbologica, 18, 1, 59-71.
- Šijačić-Nikolić M., Knežević R., Milovanović J. (2008). Contribution to the study of juvenile stage of development of hackberry (*Celtis occidentalis* L.). Bulletin of Faculty of Forestry, Belgrade, no. 97, 57-78 (in Serbian).

**CONTAINER TYPE AS A FACTOR OF GROWTH AND DEVELOPMENT OF
PEDUNCULATE OAK (*Quercus robur* L.) SEEDLINGS**

Popović Vladan* , Ćirković-Mitrović Tatjana, Lučić Aleksandar, Rakonjac Ljubinko

* Corresponding author: vladanpop79@gmail.com

Popović V., Ćirković-Mitrović T., Lučić A., Rakonjac Lj. (2015). Container type as a factor of growth and development of pedunculate oak (*Quercus robur* L.) seedlings. In: Ivetić V., Stanković D. (eds.) Proceedings: International conference Reforestation Challenges. 03-06 June 2015, Belgrade, Serbia. Reforesta. pp. 296-301.

Abstract: In this paper are presented the research results of the effect of the container type on growth and morphological characteristics of pedunculate oak seedlings in the nursery and after their transplanting to the field. In the experiment were used three types of containers: Bosnaplast 18, Bosnaplast 12 and HIKO V265.

Seed was collected in autumn 2012 in the pedunculate oak seed stand with registration number RS-2-2-qro-12-197 which is managing by FE Kragujevac and seed sowing in the containers was done in spring 2013 in the seedling nursery of Institute of Forestry in Belgrade.

The survival rate of seedlings was determined in the autumn 2013 and then was performed the analysis of morphological characteristics of seedlings. The height and the root collar diameter of seedlings have been measured. Then the seedlings were transplanted into the field, to a part of Belgrade called Veliko ratno ostrvo (Great War Island). In the autumn 2014 it was again determined the survival rate of seedlings and the analysis of their morphological characteristics has been performed. The height and the root collar diameter of seedlings have also been measured again.

The seedling survival rate was not affected by the type of container in which the seedlings were produced. The seedlings produced in containers Bosnaplast 18 with cell volume of 220 cm³ and HIKO V265 with cell volume of 265 cm³ have larger dimensions and they are more quality than seedlings produced in containers type Bosnaplast 12 that have cell volume of 120 cm³. Researches have shown that container volume has the positive effect on morphological characteristics of pedunculate oak seedlings in conditions of seedling nursery and after transplanting into the field.

Key words: pedunculate oak, *Quercus robur*, container, seedlings, morphological characteristics.

INTRODUCTION

The dilemma between classical and container seedling production is constantly present in the development of the nursery production technology. A number of researchers have been dealt with the container seedlings production (Elam 1981, Matić et al. 1996, Ocvirek 1997, Orlić 2000). Benefits of seedlings produced in containers compared

to seedlings produced in a conventional manner are: a higher survival rate during production and later during transplanting, they suffer less transplant shock, the period of planting is extended, the production is mechanized and the better results in afforestation of degraded lands have been achieved when using container seedlings. The main disadvantage of the container production of seedlings is the abnormal development of the root system (Orešković et al. 2006).

For the production of forest species seedlings the smaller containers have been used in both our country and the world, because they are cheaper, they reduce procurement costs for substrate, they are easier to handle and in them can be produced a larger number of plants per unit area. Such containers are suitable for the production of species with smaller seed, slower growth and less-developed root system. For species with larger seed, rapid growth and strong root system it is necessary to be used the larger containers.

Characteristics of containers, their volume and dimensions of the cells have a major effect on the physiology and morphology of seedlings in the nursery and later in a forest culture. Therefore, it is important to determine how these characteristics affect the growth and development of seedlings in order to produce the higher quality and more developed seedlings that will be successfully used for afforestation.

In this paper was studied the effect of the type of container on the growth and development of one-year-old pedunculate oak seedlings in the nursery and a year after their transplanting in the field.

MATERIAL AND METHOD

The trial was established in the spring 2012 in the nursery of Institute of Forestry in Belgrade, with four replications. Seed of pedunculate oak (*Quercus robur* L.) was collected in the first week of October 2012 in the seed stand with the registration number RS-2-2-qro-12-197, FMU "Rogot" department 2a, Forest administration Kragujevac, FE Kragujevac. The germinated acorns were manually sown in containers in April 2013 in the nursery of Institute of Forestry in Belgrade. For the trial were used three types of containers that are commonly used in the production of seedlings in Serbia: Bosnaplast 12 with dimensions 36x25, 5x12, with 55 cells in the block and the volume of each cell of 120 cm³, Bosnaplast 18 with dimensions 32x21, 2x18 cm, with 33 cells in the block and the volume of each cell of 220 cm³ and HIKO V265 with dimensions 35,2x21, 6x15 cm with 28 cells in the block and the volume of each cell of 265 cm³.

The containers were filled with peat that is used in a regular nursery production. Watering was performed regularly and the protective measures like shade cloth and protection from disease were also applied. At the end of the growing season in October 2013 the survival rate was determined and the height and the root collar diameter were measured. The height of the seedlings was measured with a ruler with an accuracy of 1 mm and the root collar diameter was measured with a vernier scale with an accuracy of 0.01 mm. In November 2013 the seedlings were transplanted into the field, to a part of Belgrade called Veliko ratno ostrvo (Great War Island). Seedlings were planted at a

distance of 3x3 m. During the growing season 2014 the hoeing and mowing of entire surface were carried out.

At the end of the growing season in October 2014 the survival rate was determined and the height and the root collar diameter were measured again. The height of the seedlings was measured with a ruler with an accuracy of 1 mm, and the root collar diameter was measured with a vernier scale with an accuracy of 0.01 mm. The descriptive statistics and the analysis of variance were done for all analysed variables and for all tests the error of 5% was considered statistically significant. The statistical analyses were performed using the statistical package Statgraph 5.01.

RESULTS AND DISCUSSION

Fundamental laws of nutrition apply for all plants, and a good and healthy growth can only be achieved if all the factors that regulate growth are evenly distributed and in the correct ratio (Bala, Fricker 1971). The amount of reserve nutrients in the soil (substrate) directly affects the nutritional status of plants.

Growth of seedlings in the first year is particularly important for future survival and development of plants (Larsen 2007). The studies (Walker, Hunt 1999) have shown that the seedling height best forecasts the growth while the root collar diameter best forecasts the survival of seedlings after transplanting.

The analysis of the survival rate of seedlings in the nursery has showed that the type of container did not affect the survival of pedunculate oak seedlings. The survival rate of pedunculate oak seedlings produced in containers Bosnaplast 12, Bosnaplast 18 and HIKO V265 ranged from 84.2 to 87.6%.

From Table 1 it can be seen that the seedlings produced in containers with a higher volume of cells have larger dimensions.

Table 1: Summary statistics, analysis of variance and post-hoc test for root collar diameter and height of seedlings in the nursery

Container type	Root collar diameter	Height of plants
	Average	Average
B12	3.22±0.51 ^a	21±4.72 ^a
B18	3.96±0.73 ^b	22.1±6.98 ^a
HIKO V265	4.06±0.63 ^b	21.6±4.92 ^a
P-value	0.0000	0.3428

In our studies the root collar diameter of seedlings in the nursery varies depending on the type of the container (Table 1). The seedlings produced in the containers type Bosnaplast 12 reach average root collar diameter of 3.22 mm. the seedlings produced in the containers type Bosnaplast 18 reach average root collar diameter of 3.96 mm while the seedlings produced in the containers type HIKO V265 reach average root collar diameter of 4.06 mm. The analysis of variance showed that there are statistically significant differences in root collar diameter depending on the type of container and this was confirmed by post-hoc test (Table 1).

The container type did not significantly affect the height of the seedlings in the nursery. The highest mean height of 22.1 cm was measured in seedlings produced in the containers type Bosnaplast 18 and the lowest mean height of 21 cm was measured in seedlings produced in the containers type Bosnaplast 12. The mean height of 21.6 cm was measured in seedlings produced in containers HIKO V265. The analysis of variance showed that differences in reached mean height of seedlings depending on the type of container are not statistically significant (Table 1).

The analysis of the survival rate of the seedlings in the field trial showed that the type of container in which the seedlings were produced did not affect their survival. The survival rate of seedlings produced in containers Bosnaplast 12 was 75.7%. in containers type Bosnaplast 18 was 68.6% and in containers type HIKO V265 the survival rate of seedlings was 72.4%.

Table 2: Summary statistics analysis of variance and post-hoc test for root collar diameter and height of seedlings in the field trial

Container type	Root collar diameter	Height of plants
	Average	Average
B12	6.65±1.22a	33.6±7.44a
B18	7.27±2.13b	37.7±9.11a
HIKO V265	7.35±2.44b	36.1±10.34a
P-value	0.0007	0.0002

The root collar diameter of seedlings in the field trial varies depending on the type of the container in which they were produced. The lowest root collar diameter of 6.65 mm was measured in the seedlings produced in containers type Bosnaplast 12 while the greatest root collar diameter of 7.35 mm was measured in the seedlings produced in containers type HIKO V265. In the seedlings produced in containers type Bosnaplast 18 the average root collar diameter was 7.27 mm. The analysis of variance showed that there are statistically significant differences in root collar diameter depending on the type of container and this was confirmed by post-hoc test (Table 2).

The container type affected the height of the seedlings in the field trial. The highest mean height of 37.7 cm was measured in the seedlings produced in the containers type Bosnaplast 18 and the lowest mean height of 33.6 cm was measured in the seedlings produced in the containers type Bosnaplast 12. The mean height of 36.1 cm was measured in the seedlings produced in the containers HIKO V265. The analysis of variance showed that there are statistically significant differences in height of seedlings depending on the type of container and this was confirmed by post-hoc test (Table 2).

Similar conclusions that the volume of container cell has a positive effect on morphometric characteristics of seedlings in their research got Seletković 2011. in a trial with Austrian pine. The morphological characteristics of one-year-old seedlings of common cypress are directly dependent on the volume of container (Topić et.al 2009). In researches on pedunculate oak and sessile oak have been found that volume of container cell does not significantly affect the growth of seedlings. but definitely a higher volume of container gives the seedlings of larger dimensions (Orešković et al. 2006). Volume of container directly affects the growth of *Pinus pinea* seedlings meaning that in containers

with a maximum volume were produced the best developed seedlings (Topić et.al 2009). In trails on bald cypress it was found that the volume of containers positively affects morphological characteristics of the seedlings (Popovic et al. 2013). The seedlings of cypress produced in containers of larger dimensions achieve significantly better results after afforestation regarding growth and increment (Topić et al. 2009).

CONCLUSIONS

The conducted researches show that there is a strong relation between physical characteristics of the containers or their dimensions and the growth of the pedunculate oak seedlings in both the nursery and in the field.

The physical characteristics of the containers did not affect the survival rate of pedunculate oak seedlings in the nursery nor in the field trial.

Researches carried out in this paper showed that there is a strong effect of physical characteristics of containers on growth of pedunculate oak one-year-old seedlings in the seedling nursery and after the first year in the field. Seedlings produced in containers with the higher volume of cells (Bosnaplast 18 and HIKO V265) reached greater values of height and root collar diameter compared to seedlings produced in containers with the lower volume of cells (Bosnaplast 12).

According to our researches it is recommended that in the production of pedunculate oak seedlings have to be used containers of greater dimensions and greater cell volume. A sufficient amount of nutrients will provide the more intense growth of seedlings and they will have a higher starting height and root collar diameter during afforestation.

The better developed and stronger plants suffer less shock when transplanting and a substrate with greater amount of nutrients positively affects the growth of seedlings in the first few years after planting.

Acknowledgements: *The research is financed by the Ministry of Science and Technological Development of the Republic of Serbia, Project TR 31070 "The development of technological procedures in forestry with a view to an optimum forest cover realization" (2011-2014).*

REFERENCES

- Balue H., Fricker C. (1971). Fertilization of forest trees. Yugoslav agricultural forestry center. Documentation on techniques and technology in forestry No. 78.
- Elam W.W. (1981). Production of containerized Southern Red Oaks and their performance after outplanting. Proceedings of the Southern Containerised Forest Tree Seedling Conference. 25-27. 08. 1981. Savannah. Georgia.
- Larsen J. Bo. (2007). The influence of light, lime, and NPK-fertilizer on photosynthesis, respiration, transpiration and water use efficiency of different beech provenances (*Fagus sylvatica* L.). In: Improvement and Silviculture of Beech Proceedings from the 7th International Beech Symposium. IUFRO Research Group 1.10.00. 10–20 May 2004. Tehran. Iran.
- Matić S., Komlenović N., Orlić S., Oršanić M. (1996) Nursery production of Pedunculate oak. In: D. Klepac (editor). Pedunculate oak (*Quercus robur* L.) in Croatia. Croatian Academy of Sciences and Arts. Hrvatske šume d.o.o. Zagreb. 159–166. Zagreb.

PROCEEDINGS
International Conference **REFORESTATION CHALLENGES**
03-06 June 2015, Belgrade, Serbia

- Ocvirek M. (1997). Effect of sowing period on the development of Pedunculate oak (*Quercus robur* L.) seedlings in three types of containers. Papers of Institute of Forestry Jastrebarsko 32 (2): 55-72.
- Orešković Ž., Dokuš A., Harapin M., Jakovljević T., Maradin R. (2006). Growing of seedlings Pedunculate oak (*Quercus robur* L.) and Sessile-flowered oak (*Quercus petraea* (Matt.) Liebl) in different types of containers. Papers of Institute of Forestry. Special issue 9: 75–86.
- Orlić S. (2000). Production of Pedunculate oak (*Quercus robur* L.) seedlings in Croatia. 1992–1998. Papers of Institute of Forestry 35 (1): p. 83–90.
- Popović V., Ćirković-Mitrović T., Rakonjac Lj., Lavadinović V., Lučić A. (2013). Effect of container type on growth of seedlings of Bald cypress (*Taxodium distichum* (L.) Rich.). International scientific conference Forest research institute at the Bulgarian academy of sciences. 85th anniversary. p. 59.
- Seletković I., Potočić N., Topić V., Butorac L., Jelić G., Jazbec A. (2011). Effect of various container types and slow- released fertilizer doses on growth and physiological parameters of Austrian Pine (*Pinus nigra* Arn.) seedlings. Šumarski list (Forestry journal) –special issue. 90-102.
- Topić V., Butorac L., Đurđević Z., Kekelić B., Jelić G. (2009). Effect of container type on growth and development of seedlings of Common Cypress (*Cupressus sempervirens* var. *pyramidalis* Nyman) in nursery and forest cultures. Šumarski list (Forestry journal) No. 3–4. 121-134.
- Topić V., Đurđević Z., Butorac L., Jelić G. (2006). Effect of container type on growth and development of Mediterranean stone pine (*Pinus pinea* L.) in the nursery. Paper of Croatian Forest Research Institute. special edition 9: 149–158. Jastrebarsko.
- Walker R.F., Hunt C.D. (1999). Growth and Nutrition of Containerized Singleleaf Pinyon Seedlings in Response to Controlled Release Fertilization. Arid Soil Research and Rehabilitation. 13: 123–132.
- Ćirković-Mitrović T., Popović V., Brašanac-Bosanac Lj., Rakonjac Lj., Lučić A. (2012). The effect of application of different nutrition preparations on height increment of walnut (*Juglans regia* L.) seedlings. Sustainable Forestry, collection 65-66. pp: 73-82.